

Servo solenoid valves with on-board electronics (OBE)

RE 29045/10.05
Replaces: 01.05

1/12

Type 5WRPE 10

Size 10
Unit series 2X
Maximum working pressure P_1, P_2, A, B 210 bar, T 50 bar
Nominal flow rate 70 l/min (Δp 11 bar)

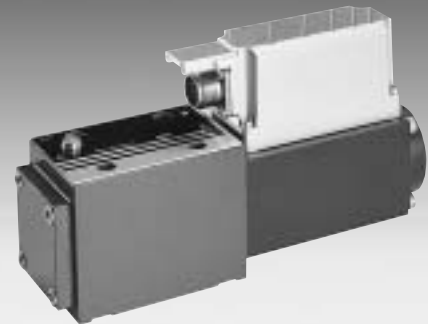

List of contents

Contents	Page
Features	1
Ordering data	2
Preferred types	2
Function, sectional diagram	3
Symbol	3
Technical data	4 to 6
On-board trigger electronics	7
Performance curves	8
Unit dimensions	9
Pressure compensator	10 and 11

Features

- Directly operated servo solenoid valve NG10, with p/Q 5/3-way symbol in servo quality
- Actuated on one side, A-T fail-safe position when switched off
- Control solenoid with integral position feedback and on-board electronics (OBE), calibrated at the factory
- Electrical connection 6P+PE
Signal input difference amplifier with interface A1 ± 10 V
- Suitable for electrohydraulic controllers in production and testing systems
- For subplate attachment, mounting hole configuration to ISO 4401-05-04-0-94
- Subplates as per catalogue section RE 45055 (order separately)
- Line sockets to DIN 43563-AM6, see catalogue section RE 08008 (order separately)

Variants on request

The 5 hydraulic connections are required for the function "Dual flow-through", $P_1 \rightarrow A$ and $P_2 \rightarrow B$, see hole pattern on page 8. Closed-loop control of p/Q is achieved with an external pressure compensator (accessory).

Ordering data

5WRP	E		10	F	B	70	L	- 2X/	G24	K0/A1	M	*
-------------	----------	--	-----------	----------	----------	-----------	----------	--------------	------------	--------------	----------	----------

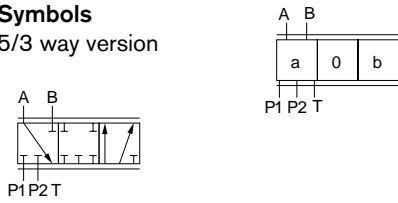
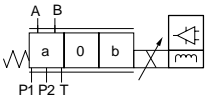
<p>With on-board trigger electronics = E</p> <p>Without sleeve no designation</p> <p>Size 10 = 10</p> <p>Symbols 5/3 way version</p>  <p>Side of inductive position transducer</p>  <p>(Standard) = B</p>	<p>Further information in plain text</p> <p>M = NBR seals, suitable for mineral oils (HL, HLP) to DIN 51524</p> <p>Interface for trigger electronics</p> <p>A1 = Setpoint input ±10 V</p> <p>K0 = Electrical connection without line socket with plug to DIN 43563-AM6 Order line socket separately</p> <p>G24 = Voltage supply of trigger electronics +24 V DC</p> <p>2X = Unit series 20 to 29 (installation and connection dimensions unchanged)</p> <p>L = Flow characteristic Linear</p> <p>Nominal flow rate at 11 bar valve pressure difference (11 bar/metering notch)</p> <p>Size 10 70 = 70 l/min</p>
---	--

Preferred types

Type 5WRPE 10...F	Material No.
5WRPE10FB70L-2X/G24K0/A1M	0 811 402 107

Accessory, pressure compensator

	See pressure compensator on pages 11 and 12	kg	Material No.
		6	0 811 401 219

Function, sectional diagram

Servo solenoid valve 5WRPE 10

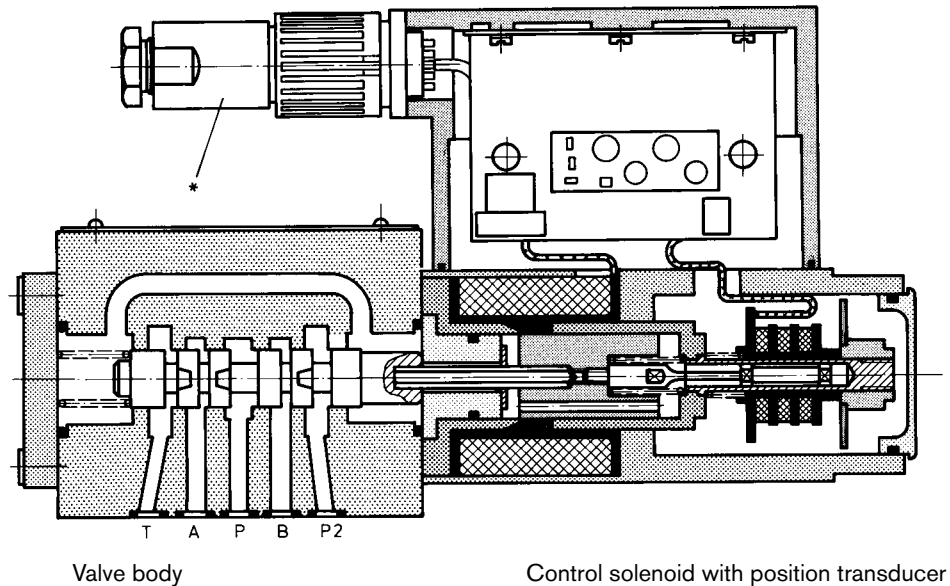

 EN 61000-6-2: 2002-08
 EN 61000-6-3: 2002-08

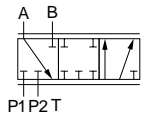

Symbol



Accessories, not included in scope of delivery

(4x)  ISO 4762-M6x40-10.9	Fastening screws		2 910 151 209
* 	Line sockets 6P+PE, see also RE 08008	KS	1 834 482 022
		KS	1 834 482 026
		MS	1 834 482 023
		MS	1 834 482 024
		KS 90°	1 834 484 252

Testing and service equipment

- Test box type VT-PE-TB3, see RE 30065
- Test adapter 6P+PE type VT-PA-2, see RE 30068



Technical data

General	
Construction	Spool type valve, operated directly
Actuation	Proportional solenoid with position control, OBE
Type of mounting	Subplate, mounting hole configuration NG10 (ISO 4401-05-04-0-94)
Installation position	Optional
Ambient temperature range	°C -20...+50
Weight	kg 7.1
Vibration resistance, test condition	Max. 25 g, shaken in 3 dimensions (24 h)

Hydraulic (measured with HLP 46, $\vartheta_{oil} = 40\text{ °C} \pm 5\text{ °C}$)

Pressure fluid	Hydraulic oil to DIN 51524...535, other fluids after prior consultation	
Viscosity range	recommended mm ² /s	20...100
	max. permitted mm ² /s	10...800
Pressure fluid temperature range	°C	-20...+70
Maximum permissible degree of contamination of pressure fluid Purity class to ISO 4406 (c)	Classe 18/16/13 ¹⁾	
Flow direction	See symbol	
Nominal flow at $\Delta p = 11\text{ bar}$ per notch ²⁾	l/min	$P_1 \rightarrow A$ 70
		$P_1 \rightarrow A + P_2 \rightarrow B$ 70+70
		$A \rightarrow T$ 65
Max. working pressure	bar	Port P_1, P_2, A, B : 210
Max. pressure	bar	Port T: 50
Operating limits at Δp	bar	See diagram
Leakage at 100 bar	 cm ³ /min	< 1,200

Static/Dynamic

Hysteresis	%	≤ 0.3
Manufacturing tolerance for Q_{max}	%	< 10
Response time for signal change 0...100%	ms	≤ 25
Thermal drift	Zero point displacement < 1 % at $\Delta T = 40\text{ °C}$	
Zero adjustment	Factory-set $\pm 1\%$	
Conformity	 EN 61000-6-2: 2002-08  EN 61000-6-3: 2002-08	

¹⁾ The purity classes stated for the components must be complied with in hydraulic systems. Effective filtration prevents problems and also extends the service life of components. For a selection of filters, see catalogue sections RE 50070, RE 50076 and RE 50081.

²⁾ Flow rate at a different Δp $Q_x = Q_{nom} \cdot \sqrt{\frac{\Delta p_x}{11}}$

Technical data

Electrical , trigger electronics integrated in the valve	
Cyclic duration factor	% 100
Degree of protection	IP 65 to DIN 40050 and IEC 14434/5
Connection	Line socket 6P+PE, DIN 43563
Power supply	24 V DC _{nom}
Terminal A:	min. 21 V DC/max 40 V DC
Terminal B: 0 V	Ripple max. 2 V DC
Power consumption	Solenoid \square 60 mm = 60 VA max.
External fuse	2.5 A _F
Input, "Standard" version	Difference amplifier, $R_i = 100 \text{ k}\Omega$
Terminal D: U_E	0...±10 V
Terminal E:	0 V
Max. differential input voltage at 0 V	$D \rightarrow B$ } $D \rightarrow B$ } max. 18 V DC
Test signal, "Standard" version	LVDT
Terminal F: U_{test}	0...±10 V
Terminal C:	Reference 0 V
Protective conductor and screen	See pin assignment (installation conforms to CE)
Recommended cable	See pin assignment up to 20 m 7x0.75 mm ² up to 40 m 7x1 mm ²
Calibration	Calibrated at the factory, see valve performance curve

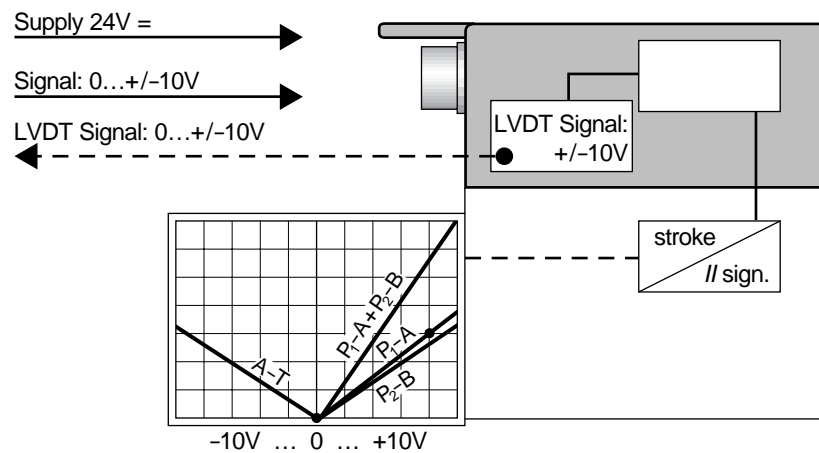

Connection

For electrical data, see page 5 and
Operating Instructions 1 819 929 083

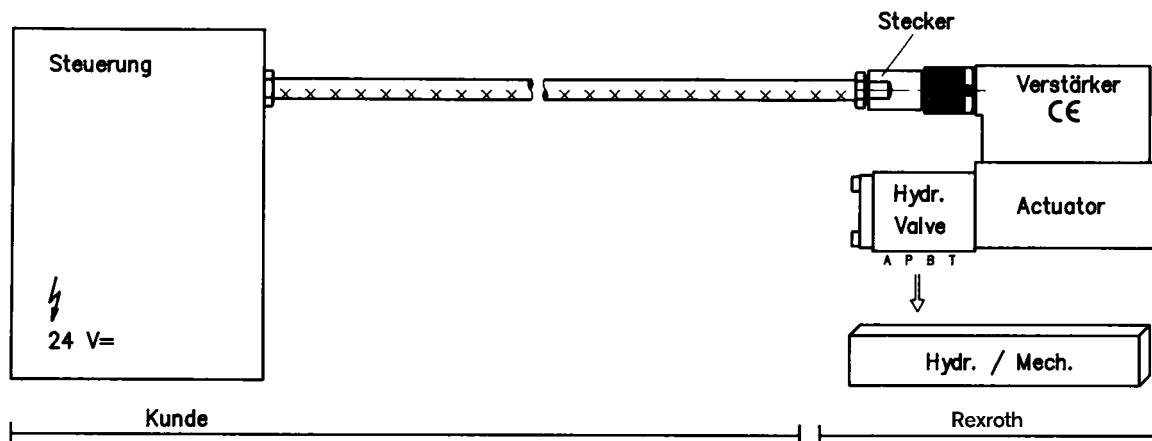

Technical notes on the cable

- Version:**
- Multi-wire cable
 - Extra-finely stranded wire to VDE 0295, Class 6
 - Protective conductor, green/yellow
 - Cu braided screen
- Types:**
- e.g. Ölflex-FD 855 CP (from Lappkabel company)
- No. of wires:**
- Determined by type of valve, plug types and signal assignment
- Cable Ø:**
- 0.75 mm² up to 20 m length
 - 1.0 mm² up to 40 m length
- Outside Ø:**
- 9.4...11.8 mm – Pg11
 - 12.7...13.5 mm – Pg16

Note

Voltage supply 24 V DC_{nom},
if voltage drops below 18 V DC, rapid shutdown resembling
“Enable OFF” takes place internally.
Electrical signals emitted via the trigger electronics (e.g. actual values) must not be used to shut down safety-relevant machine functions! (See European Standard, “Technical Safety Requirements for Fluid-Powered Systems and Components – Hydraulics”, EN 982.)

On-board trigger electronics

Block diagram/pin assignment

Version A1: U_{D-E} 0...±10 V

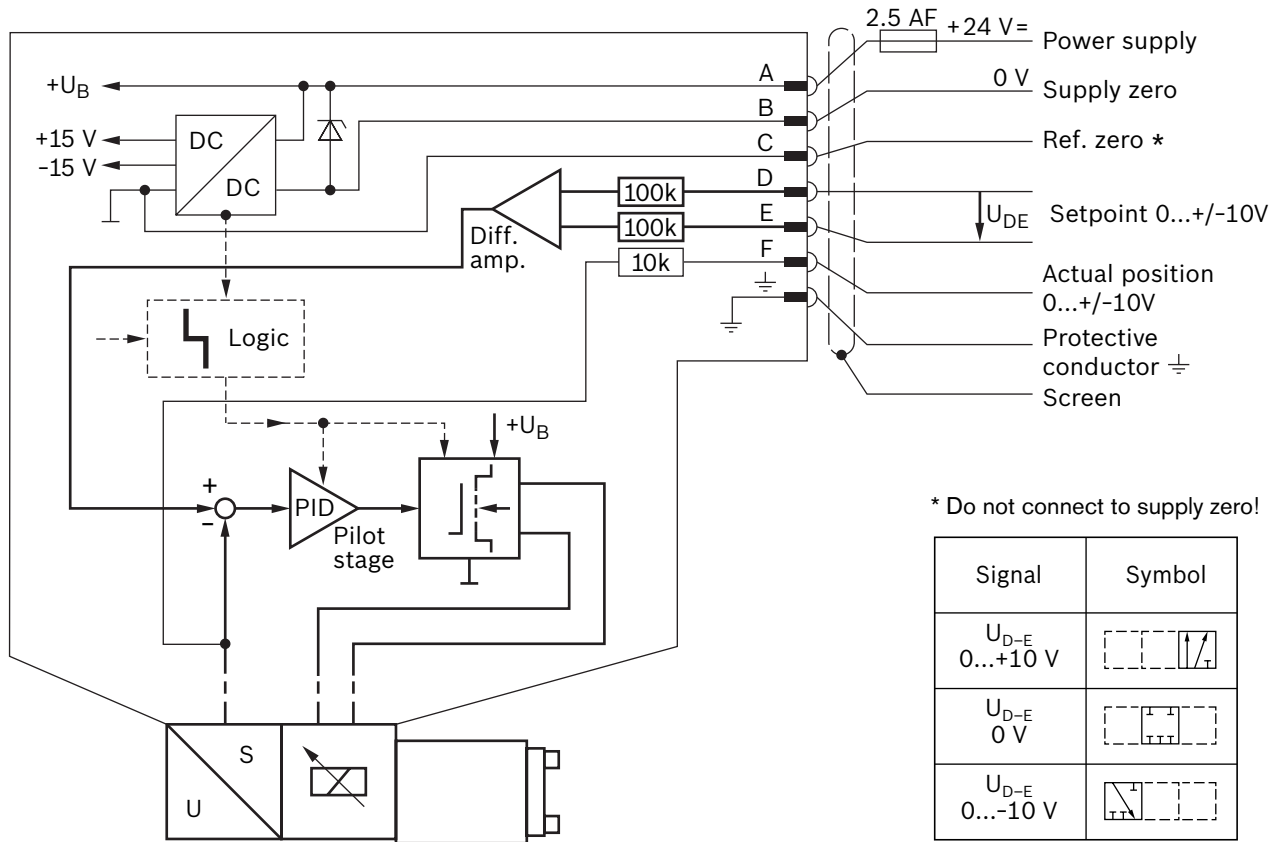

Pin assignment 6P+PE

Version A1: U_{D-E} ±10 V

($R_i = 100 \text{ k}\Omega$)

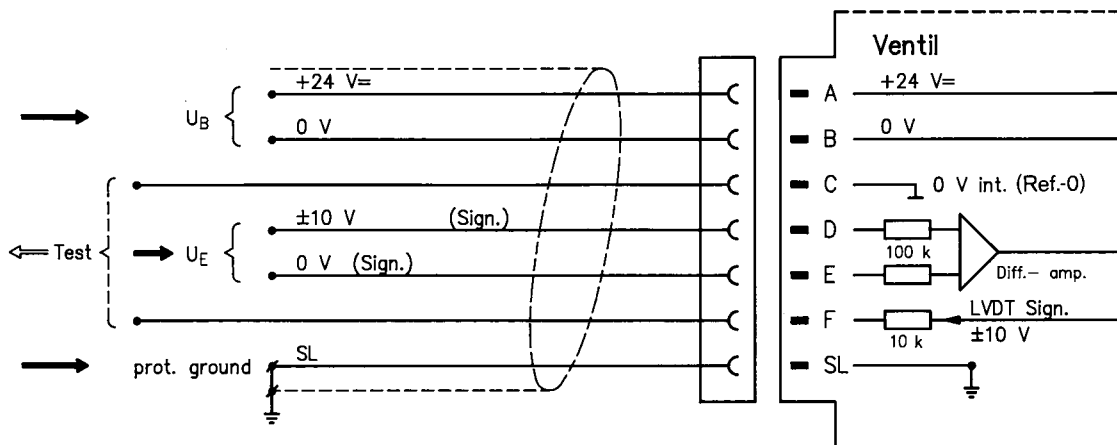

Performance curves (measured with HLP 46, $\vartheta_{oil} = 40^\circ\text{C} \pm 5^\circ\text{C}$)

Flow rate/Signal function

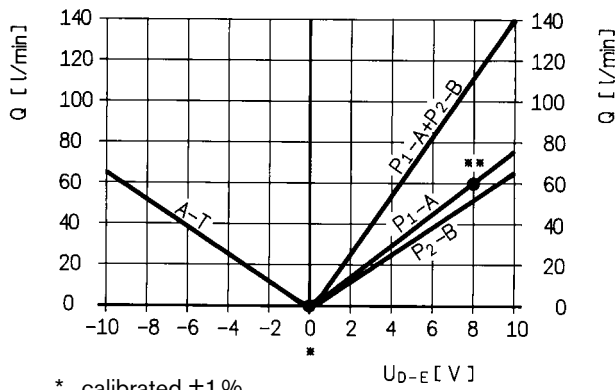

* calibrated $\pm 1\%$
 ** calibrated $\pm 5\%$

Operating limits

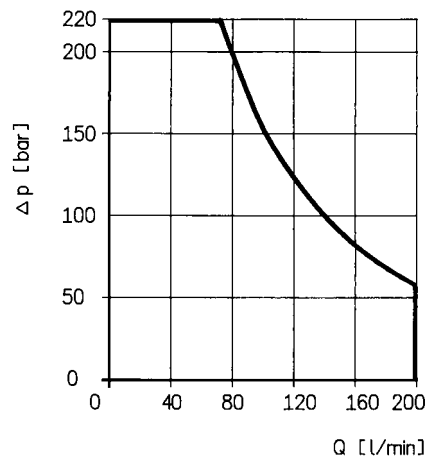

Pressure gain

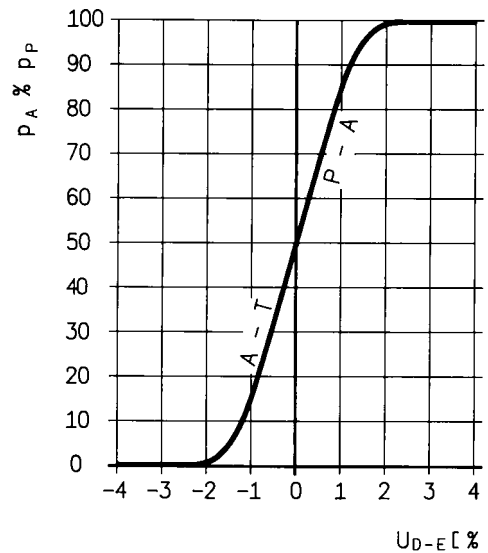
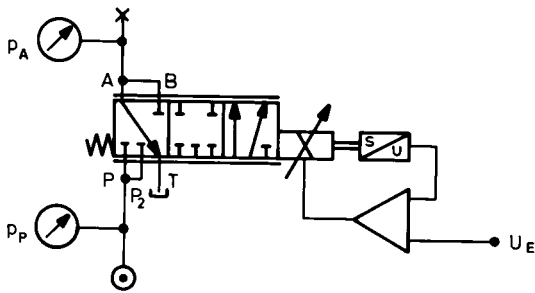

Bode diagram

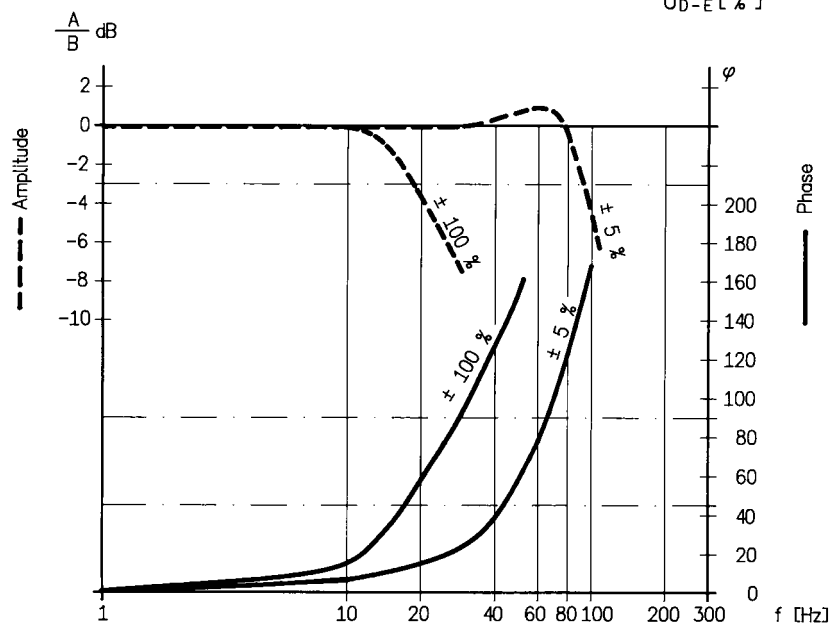
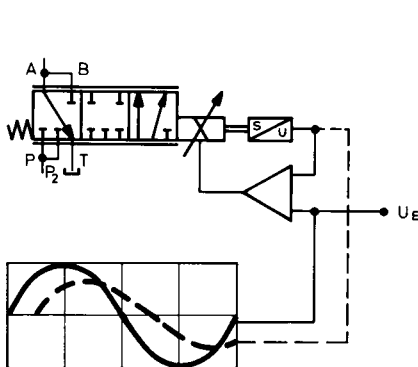

Unit dimensions (nominal dimensions in mm)

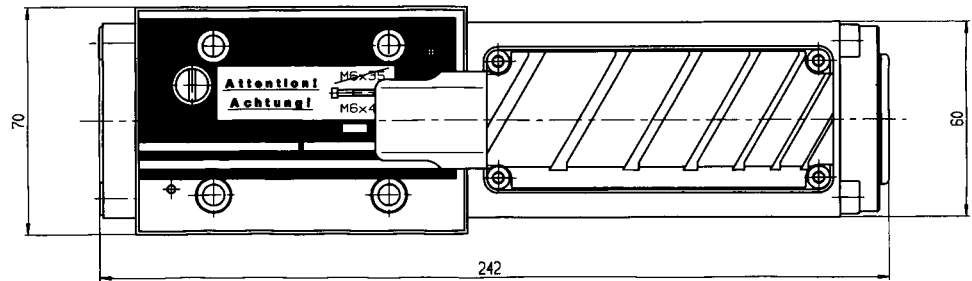
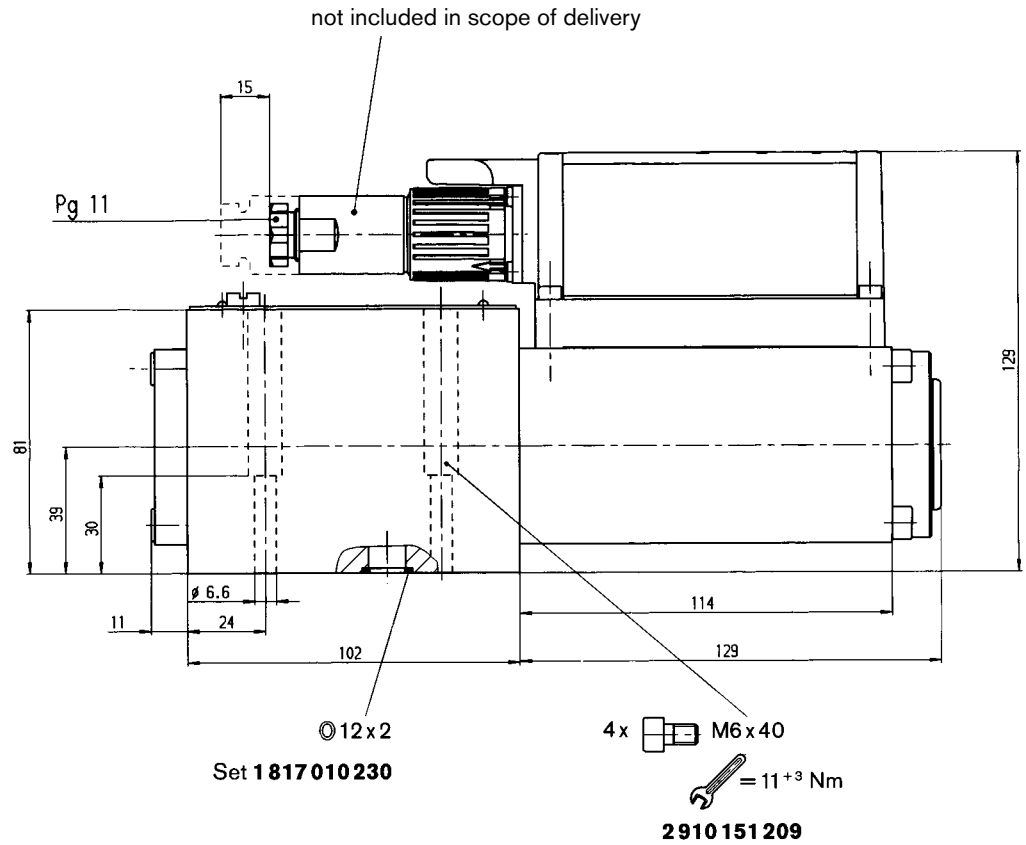

Required surface quality of mating component

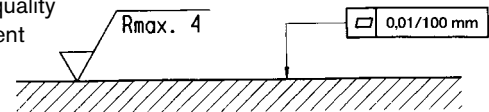

Mounting hole configuration: NG10 (ISO 4401-05-04-0-94)

For subplates, see catalogue section RE 45055

¹⁾ Deviates from standard

²⁾ Thread depth:

Ferrous metal 1.5 x Ø*

Non-ferrous 2 x Ø

* (NG10 min. 10.5 mm)

** 5/3 - NG10
R = P₂

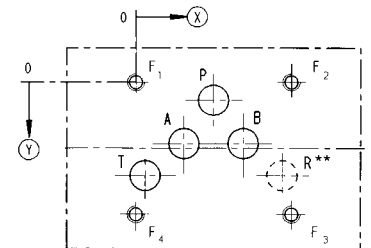

	P	A	T	B	F ₁	F ₂	F ₃	F ₄	R
⊗	27	16.7	3.2	37.3	0	54	54	0	50.8
⊙	6.3	21.4	32.5	21.4	0	0	46	46	32.5
∅	10.5 ¹⁾	10.5 ¹⁾	10.5 ¹⁾	10.5 ¹⁾	M6 ²⁾	M6 ²⁾	M6 ²⁾	M6 ²⁾	10.5 ¹⁾

Pressure compensator

Size 10



Application

A combination of flow rate control and pressure compensation. The **flow rate Q** is determined by the throttle cross-sections P_1, R, A and P_2, R, B . Either a single or a double flow may be selected. In many applications, the valve is combined with a variable-displacement pump. The pressure/flow compensator keeps the pressure drops through the valve at a constant level (see Fig. 1 on page 11).

The same function is achieved in constant-displacement pumps, too, by means of a pressure compensator. Here, Q_{max} is determined by the control springs of the pressure compensator (see Fig. 2 on page 11).

The **pressure p** is measured by an external pressure sensor and transmitted to an electronic pressure compensator as an actual value. Just as the build-up of pressure in the consumer takes place and approaches the setpoint value, the valve function is determined by the pressure compensator. Even in situations where the pressure is decreasing, the valve can regulate the oil as necessary via the A-T metering notch. Pressure compensation can be achieved both by means of electronics provided by the customer and using a Rexroth pressure compensator.

Note

You will find more detailed information in the RE data sheets:
 – Pressure sensors RE 30271
 – p/Q regulator RE 30134.

Symbol		p_{max} [bar]	Δp [bar]	Q_{nom} [l/min]	[kg]	Material No.
	p/Q -NG10	210	8	120	6.0	0811 401 219
	ISO 4762-M6x115-10.9					–
	ISO 4762-M6x120-10.9					2910 151 227

Application

Figure 1: with variable-displacement pump

Figure 2: with pressure compensator 0811 401 219

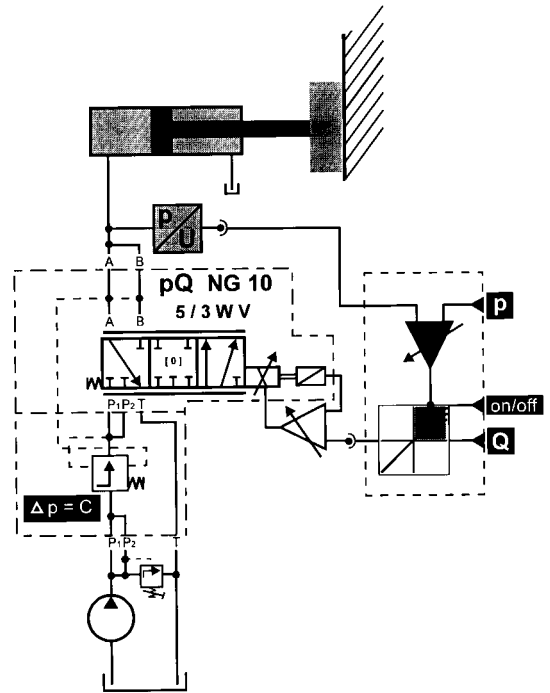
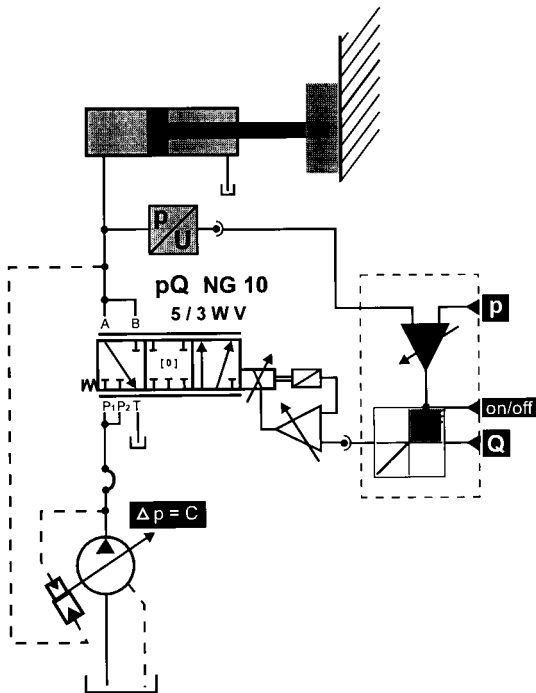

Unit dimensions (nominal dimensions in mm)

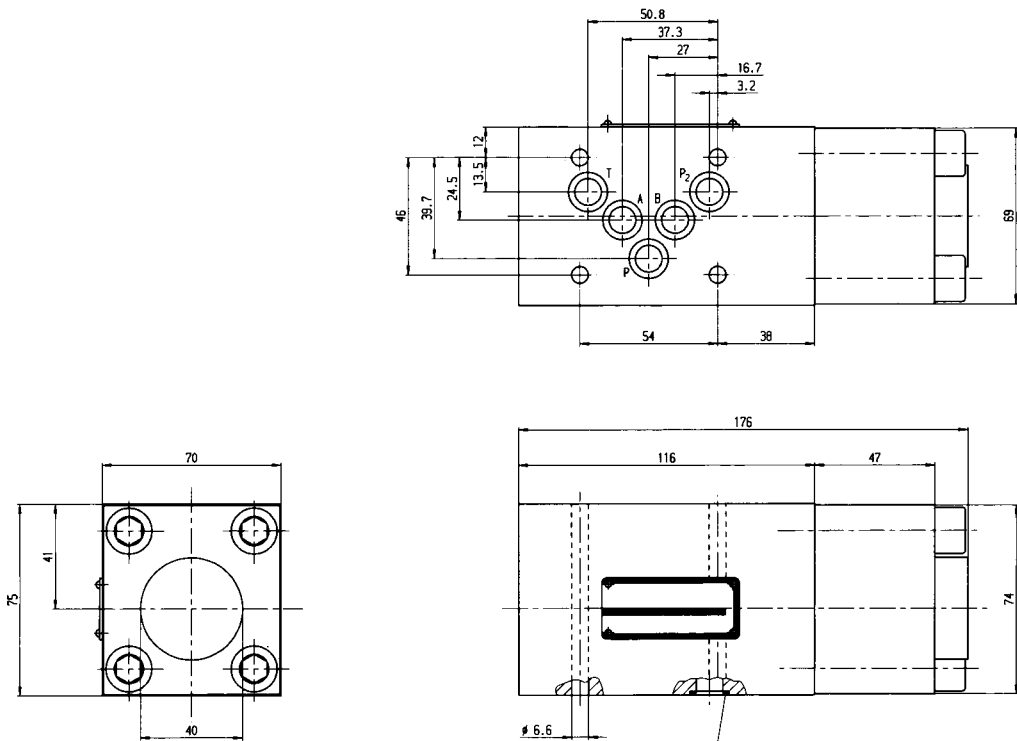

Set 1817 010 230

Required surface quality of mating component

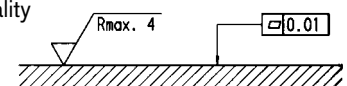

Notes
