

## MSUD VALVE PLUG FORM A 18MM

PUR 5X0.75 black 1m

Form A (18 mm) for pressure switch  
24 V DC with LED (red/green)

Further cable lengths on request. Plastic housings with good resistance against chemicals and oils. The resistance to aggressive media should be individually tested for your application. Further details on request.

### [Link to Product](#)

#### Illustration

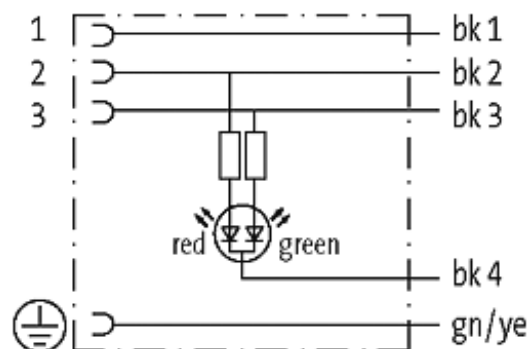



Product may differ from Image

### Approvals



### Form

18121

### Technical Data

Operating voltage	24 V DC $\pm 25\%$
Operating current per contact	max. 4 A
Locking of ports	M3 (recommended torque 0.4 Nm)
Housing	Black plastic (gray on request)
Protection	IP67 inserted and tightened (EN 60529)

### Cables

Cable number	628
No./diameter of wires	5 $\times$ 0.75 mm <sup>2</sup>
Wire isolation	PVC (bk, num, gnye)
C-track properties	2 Mio.
Jacket Color	black
Shore hardness outer jacket	85 $\pm$ 5A
Material (jacket)	PUR/PVC (UL/CSA)
Outer diameter	approx. 7.0 mm
Bend radius (fixed)	10 $\times$ outer $\varnothing$
Bend radius (moving)	15 $\times$ outer $\varnothing$
Temperature range (fixed)	-30...+80 °C
Temperature range (mobile)	-5...+80 °C

### Commercial data

country of origin	CZ
customs tariff number	85444290
minimum order quantity	1