

ALPS® ALPS ELECTRIC EUROPA GmbH

Customer : ALPS EUROPE Distribution
 Attention :
 Your ref.:
 Your part No.:

No: **DMT-09-005**
 Date: **10.03.2009**

SPECIFICATION

PURPOSE OF THIS DOCUMENT:

- Preliminary copy.
- Request for your Approval.
 ([X] New [] Engineering Change)
- Please sign and return one copy.
- APPROVED BY: _____ Date: _____

ALPS:

Model : **TACT SWITCH**
SKRBAAE010
 Spec. No: **KRB-708**
 Sample No: _____

X
 Name _____
 Title _____

For Production

REMARKS:

Designed : R. Krueger
 Approved : T. Kato

ENG. DEPT. DORTMUND FACTORY

SYMB REVISIONS

CIRCUIT DIAGRAM

回路図

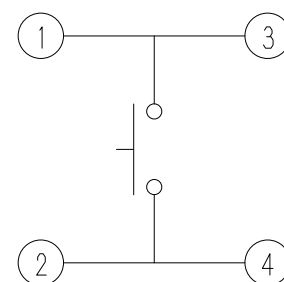

PRINTED CIRCUIT BOARD LAND DIMENSION
 推奨ランド寸法 (10:1)
 WHEN VIEWED FROM THE SWITCH MOUNTING FACE
 スイッチ取り付け面より見る

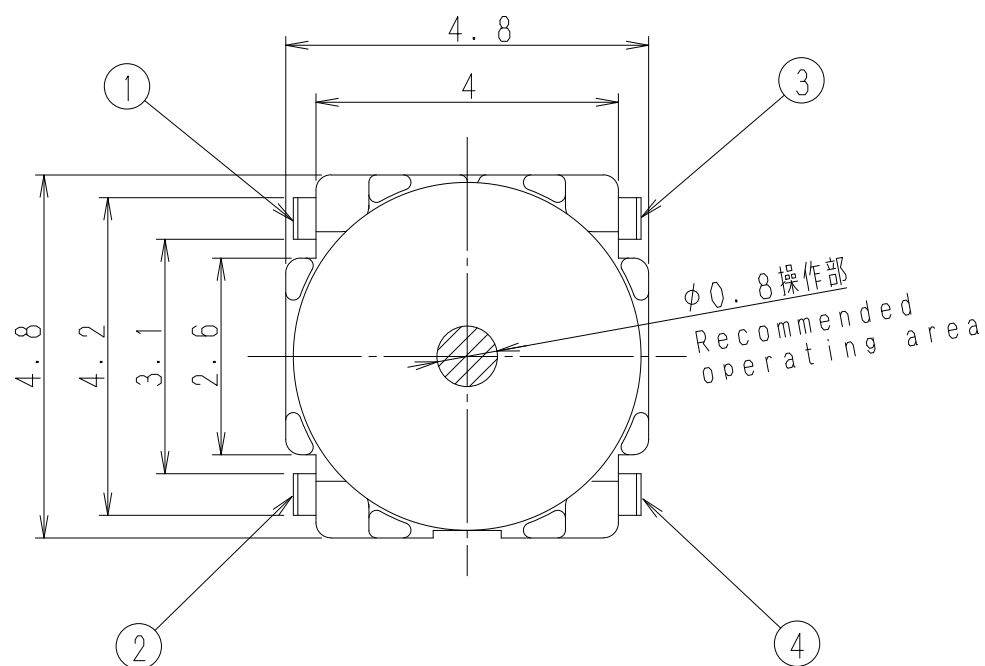
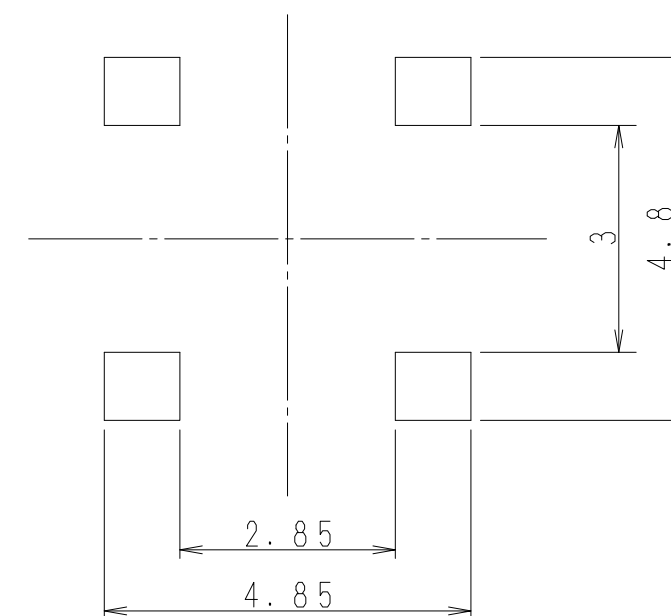

φ0.8 操作部
 Recommended operating area

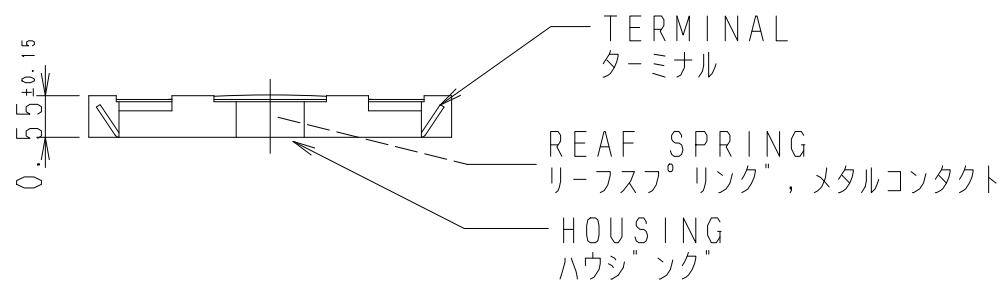

NOTE
 1. TAPING SPECIFICATION TO BE ACCORDANCE WITH TRB-901.

注記
 1. テーピング仕様はTRB-901による。

PART NO.	MATERIAL	SPEC/NAME	FINISH	REMARK
ALPS ELECTRIC CO., LTD.				
	DSGD. 2000.01.17 DS1	SCALE 10:1	NO. SKRBAAE010	
	H. KOZUMA		TITLE	PRODUCT DRAWING (製品図)
	CHKD. 2000.01.17 DS1		J. TSUTSUMI	DOCUMENT NO.
	APPD. 2000.01.17 DS1	UNIT mm		
	J. TSUTSUMI			

TOLERANCE UNLESS OTHERWISE SPEC.	
BASIC DIMENSIONS	TOLERANCES
UP TO 10	±0.3
ABOVE 10 TO 100	±0.5
ABOVE 100	±0.8
ANGULAR DIMENSIONS	±3°

NO.	SYMB	DATE	APPD	CHKD	DSGD

APPROVED

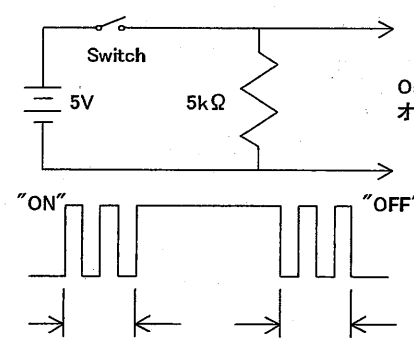
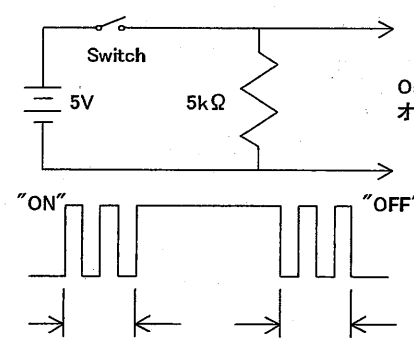
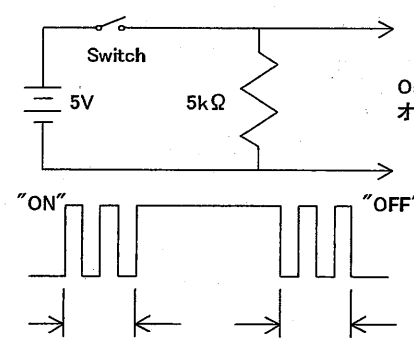
DOCUMENT No. KRB-708	TITLE PRODUCT SPECIFICATIONS 製品仕様書	PAGE 1/6															
BACKGROUND																	
<p>1. General 一般事項</p> <p>1.1 Application 適用範囲 This specification is applied to TACT switches which have no keytop. この規格書は、キートップなしのタクトスイッチについて適用する。</p> <p>1.2 Operating temperature range 使用温度範囲: $-40 \sim 85^{\circ}\text{C}$ (normal humidity, normal air pressure 常湿・常圧)</p> <p>1.3 Storage temperature range 保存温度範囲: $-40 \sim 90^{\circ}\text{C}$ (normal humidity, normal air pressure 常湿・常圧)</p> <p>1.4 Test conditions 試験状態 Unless otherwise specified, the atmospheric conditions for making measurements and tests are as follows. 試験及び測定は特に規定がない限り以下の標準状態のもとで行う。 Normal temperature 常 温: (Temperature 温度 $5 \sim 35^{\circ}\text{C}$) Normal humidity 常 湿: (Relative humidity 湿度 $25 \sim 85\%$) Normal air pressure 常 圧: (Air pressure 気圧 $86 \sim 106\text{kPa}$) If any doubt arise from judgement, tests shall be conducted at the following conditions. ただし、判定に疑義を生じた場合は以下の基準状態で行う。 Ambient temperature 温 度: $20 \pm 2^{\circ}\text{C}$ Relative humidity 相対湿度: $60 \sim 70\%$ Air pressure 気 圧: $86 \sim 106\text{kPa}$</p> <p>2. Appearance, style and dimensions 外観、形状、寸法</p> <p>2.1 Appearance 外観 There shall be no defects that affect the serviceability of the product. 性能上有害な欠陥があつてはならない。</p> <p>2.2 Style and dimensions 形状、寸法 Refer to the assembly drawings. 製品図による。</p> <p>3. Type of actuating 動作形式 <u>Tactile feedback</u> <u>タクティールフィードバック</u></p> <p>4. Contact arrangement 回路形式 <u>1poles 1throws</u> <u>1回路 1接点</u> (Details of contact arrangement are given in the assembly drawings 回路の詳細は製品図による)</p> <p>5. Ratings 定格</p> <p>5.1 Maximum ratings 最大定格 <u>12 V DC</u> <u>50 mA</u></p> <p>5.2 Minimum ratings 最小定格 <u>1 V DC</u> <u>10 μA</u></p> <p>6. Electrical specification 電気的性能</p> <table border="1"> <thead> <tr> <th>Items 項目</th> <th>Test conditions 試験条件</th> <th>Criteria 判定基準</th> </tr> </thead> <tbody> <tr> <td>6.1 Contact resistance 接触抵抗</td> <td>Applying a below static load to the center of the stem, measurements shall be made. スイッチ操作部中央に下記の静荷重を加え、測定する。 (1) Depression 押圧力: <u>3.14 N</u> (2) Measuring method 測定方法: 1 kHz small-current contact resistance meter or voltage drop method at 5VDC 10mA. 1kHz微小電流接触抵抗計、又はDC5V 10mA電圧降下法</td> <td><u>100mΩ</u> MAX</td> </tr> <tr> <td>6.2 Insulation resistance 絶縁抵抗</td> <td>Measurements shall be made following the test set forth below: 下記条件で試験を行った後、測定する。 (1) Test voltage 印可電圧: <u>100 V DC</u> for 1 min. (2) Applied position 印可場所: Between all terminals. And if there is a metal frame, between terminals and ground(frame) 端子間、金属フレームがある場合は、端子と金属フレーム間</td> <td><u>100 MΩ</u> MIN</td> </tr> <tr> <td>6.3 Voltage proof 耐電圧</td> <td>Test voltage: <u>100 V AC</u> ($50 \sim 60\text{Hz}$) Duration: 1 min Applied position: Between all terminals Between terminals and ground(frame)(if there is a metal frame) AC <u>100 V</u> ($50 \sim 60\text{Hz}$) の電圧を 1分間端子間、金属フレームがある場合は、端子と金属フレーム間に印加し、測定する。</td> <td>There shall be no breakdown. 絶縁破壊のないこと。</td> </tr> <tr> <td>6.4 Bounce バウンス</td> <td>Lightly striking the center of the stem at a rate encountered in normal use (3 to 4 operations per s.), bounce shall be tested at "ON" and "OFF". スイッチ操作部の中央部を通常の使用状態(3~4回/秒)で軽く打鍵し、ON時及びOFF時のバウンスを測定する。 </td> <td>ON bounce: <u>10</u> ms. MAX. OFF bounce: <u>10</u> ms. MAX.</td> </tr> </tbody> </table>			Items 項目	Test conditions 試験条件	Criteria 判定基準	6.1 Contact resistance 接触抵抗	Applying a below static load to the center of the stem, measurements shall be made. スイッチ操作部中央に下記の静荷重を加え、測定する。 (1) Depression 押圧力: <u>3.14 N</u> (2) Measuring method 測定方法: 1 kHz small-current contact resistance meter or voltage drop method at 5VDC 10mA. 1kHz微小電流接触抵抗計、又はDC5V 10mA電圧降下法	<u>100mΩ</u> MAX	6.2 Insulation resistance 絶縁抵抗	Measurements shall be made following the test set forth below: 下記条件で試験を行った後、測定する。 (1) Test voltage 印可電圧: <u>100 V DC</u> for 1 min. (2) Applied position 印可場所: Between all terminals. And if there is a metal frame, between terminals and ground(frame) 端子間、金属フレームがある場合は、端子と金属フレーム間	<u>100 MΩ</u> MIN	6.3 Voltage proof 耐電圧	Test voltage: <u>100 V AC</u> ($50 \sim 60\text{Hz}$) Duration: 1 min Applied position: Between all terminals Between terminals and ground(frame)(if there is a metal frame) AC <u>100 V</u> ($50 \sim 60\text{Hz}$) の電圧を 1分間端子間、金属フレームがある場合は、端子と金属フレーム間に印加し、測定する。	There shall be no breakdown. 絶縁破壊のないこと。	6.4 Bounce バウンス	Lightly striking the center of the stem at a rate encountered in normal use (3 to 4 operations per s.), bounce shall be tested at "ON" and "OFF". スイッチ操作部の中央部を通常の使用状態(3~4回/秒)で軽く打鍵し、ON時及びOFF時のバウンスを測定する。 	ON bounce: <u>10</u> ms. MAX. OFF bounce: <u>10</u> ms. MAX.
Items 項目	Test conditions 試験条件	Criteria 判定基準															
6.1 Contact resistance 接触抵抗	Applying a below static load to the center of the stem, measurements shall be made. スイッチ操作部中央に下記の静荷重を加え、測定する。 (1) Depression 押圧力: <u>3.14 N</u> (2) Measuring method 測定方法: 1 kHz small-current contact resistance meter or voltage drop method at 5VDC 10mA. 1kHz微小電流接触抵抗計、又はDC5V 10mA電圧降下法	<u>100mΩ</u> MAX															
6.2 Insulation resistance 絶縁抵抗	Measurements shall be made following the test set forth below: 下記条件で試験を行った後、測定する。 (1) Test voltage 印可電圧: <u>100 V DC</u> for 1 min. (2) Applied position 印可場所: Between all terminals. And if there is a metal frame, between terminals and ground(frame) 端子間、金属フレームがある場合は、端子と金属フレーム間	<u>100 MΩ</u> MIN															
6.3 Voltage proof 耐電圧	Test voltage: <u>100 V AC</u> ($50 \sim 60\text{Hz}$) Duration: 1 min Applied position: Between all terminals Between terminals and ground(frame)(if there is a metal frame) AC <u>100 V</u> ($50 \sim 60\text{Hz}$) の電圧を 1分間端子間、金属フレームがある場合は、端子と金属フレーム間に印加し、測定する。	There shall be no breakdown. 絶縁破壊のないこと。															
6.4 Bounce バウンス	Lightly striking the center of the stem at a rate encountered in normal use (3 to 4 operations per s.), bounce shall be tested at "ON" and "OFF". スイッチ操作部の中央部を通常の使用状態(3~4回/秒)で軽く打鍵し、ON時及びOFF時のバウンスを測定する。 	ON bounce: <u>10</u> ms. MAX. OFF bounce: <u>10</u> ms. MAX.															
		DSGD. Nov. 17, 2008 DHKD. Nov. 17, 2008 APPD. 17. NOV. 2008															
PAGE	SYMB	BACKGROUND	DATE	APPD	CHKD	DSGD											

DOCUMENT No. KRB-708	TITLE PRODUCT SPECIFICATIONS 製品仕様書	PAGE 2/6
-------------------------	--	-------------

7. Mechanical specification 機械的性能

Items 項目	Test conditions 試験条件	Criteria 判定基準
7.1 Operating force 作動力	Placing the switch such that the direction of switch operation is vertical and then gradually increasing the load applied to the center of the stem, the maximum load required for the switch to come to a stop shall be measured. スイッチの操作方向が垂直になる様にスイッチを設置し、操作部中央部に徐々に荷重を加え、操作部が停止するまでの最大荷重を測定する。	1.57 (±0.49) N
7.2 Travel 移動量	Placing the switch such that the direction of switch operation is vertical and then applying a below static load to the center of the stem, the travel distance for the switch to come to a stop shall be measured. スイッチの操作方向が垂直になる様にスイッチを設置し、操作部中央部に以下の静荷重を加え、操作部が停止するまでの距離を測定する。 (1) Depression 押圧力: 3.14 N	0.2 ± 0.1 mm
7.3 Return force 復帰力	The sample switch is installed such that the direction of switch operation is vertical and, upon depression of the stem in its center the whole travel distance, the force of the stem to return to its free position shall be measured. スイッチの操作方向が垂直になる様にスイッチを設置し、操作部中央部を全移動量押圧後、操作部が復帰する力を測定する。	0.20 N MIN.
7.4 Stop strength ストッパー強度	Placing the switch such that the direction of switch operation is vertical and then a below static load shall be applied in the direction of stem operation. スイッチの操作方向が垂直になる様にスイッチを設置し、スイッチの操作方向へ以下の静荷重を加える。 (1) Depression 押圧力: 29.4 N (2) Time 時間: 15 s.	There shall be no sign of damage mechanically and electrically. 機械的、電氣的に異常のないこと。

8. Environmental specification 耐候性能

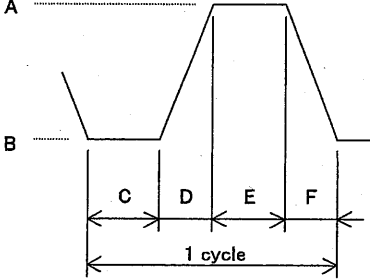
Items 項目	Test conditions 試験条件	Criteria 判定基準
8.1 Resistance to low temperatures 耐寒性	Following the test set forth below the sample shall be left in normal temperature and humidity conditions for 1 hour before measurements are made: 次の試験後、常温、常湿中に1時間放置後測定する。 (1) Temperature 温度: -40 ± 2 °C (2) Time 時間: 96 h (3) Waterdrops shall be removed. 水滴は取り除く。	Item 6. Item 7.1 Item 7.2
8.2 Heat resistance 耐熱性	Following the test set forth below the sample shall be left in normal temperature and humidity conditions for 1 hour before measurements are made: 次の試験後、常温、常湿中に1時間放置後測定する。 (1) Temperature 温度: 90 ± 2 °C (2) Time 時間: 96 h	Item 6. Item 7.1 Item 7.2
8.3 Moisture resistance 耐湿性	Following the test set forth below the sample shall be left in normal temperature and humidity conditions for 1 hour before measurements are made: 次の試験後、常温、常湿中に1時間放置後測定する。 (1) Temperature 温度: 60 ± 2 °C (2) Time 時間: 96 h (3) Relative humidity 相对湿度: 90 ~ 95 % (4) Waterdrops shall be removed. 水滴は取り除く。	Contact resistance 接触抵抗(Item 6.1): 500 m Ω MAX. Insulation resistance 絶縁抵抗(Item 6.2): 10 M Ω MIN. Item 6.3 Item 6.4 Item 7.1 Item 7.2
8.4 Change of temperature 温度サイクル	After below cycles of following conditions, the switch shall be allowed to stand under normal room temperature and humidity conditions for 1 hour, and measurement shall be made. Water drops shall be removed. 下記条件で以下回数サイクル試験後、常温常湿中に1時間放置し測定する。ただし、水滴は取り除く。  <p style="margin-left: 200px;"> A = +90 °C B = -40 °C C = 2 h D = 1 h E = 2 h F = 1 h (1) Number of cycles サイクル数 : 5 cycles </p>	Item 6. Item 7.1 Item 7.2

DOCUMENT No. KRB-708	TITLE PRODUCT SPECIFICATIONS 製品仕様書	PAGE 3/6
-------------------------	--	-------------

9. Endurance specification 耐久性能

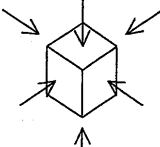
Items 項目	Test conditions 試験条件	Criteria 判定基準
9.1 Operating life 動作寿命	<p>Measurements shall be made following the test set forth below: 下記条件で試験を行った後、測定する。</p> <p>(1) <u>5</u> VDC <u>5</u> mA resistive load 抵抗負荷 (2) Rate of operation 動作速度: <u>2</u> to <u>3</u> operations per s. 回/秒 (3) Depression 押圧力: <u>2.06</u> N MAX. (4) Cycles of operation 動作回数: <u>1,000,000</u> cycles. 回</p>	<p>Contact resistance 接触抵抗(Item 6.1): <u>500</u> mΩ MAX. Insulation resistance 絶縁抵抗(Item 6.2): <u>10</u> MΩ MIN. Bounce バウンス(Item 6.4): ON bounce: <u>20</u> ms. MAX. OFF bounce: <u>20</u> ms. MAX. Operating force 作動力(Item 7.1): <u>+30</u> ~ <u>-30</u> % of initial force 初期値に対して Item 6.3 Item 7.2</p>
9.2 Vibration resistance 耐振性	<p>Measurements shall be made following the test set forth below: 下記条件で試験を行った後、測定する。</p> <p>(1) Vibration frequency range 振動数範囲: <u>10</u> ~ <u>55</u> Hz (2) Total amplitude 全振幅: <u>1.5</u> mm (3) Sweep ratio 掃引の割合: <u>10-55-10</u> Hz Approx. <u>1</u> min 約1分 (4) Method of changing the sweep vibration frequency: Logarithmic or uniform 掃引振動数の変化方法 対数又は一様掃引 (5) Direction of vibration: Three mutually perpendicular directions, including 振動の方向 the direction of the travel スイッチ操作方向を中心とした垂直3方向 (6) Duration 振動時間: <u>2</u> h each (<u>6</u> h in total) 各2時間(計6時間)</p>	<p>Item 6.1 Item 7.1 Item 7.2</p>
9.3 Shock 耐衝撃性	<p>Measurements shall be made following the test set forth below: 下記条件で試験を行った後、測定する。</p> <p>(1) Acceleration 加速度: <u>784</u> m/s² (2) Acting time 作用時間: <u>11</u> msec (3) Test direction 試験方向: 6 directions 6面 (4) Number of shocks 試験回数: <u>3</u> times per direction (<u>18</u> times in total) 各方向各3回(計18回)</p>	<p>Item 6.1 Item 7.1 Item 7.2</p>
		

DOCUMENT No. KRB-708	TITLE PRODUCT SPECIFICATIONS 製品仕様書	PAGE 4/6
-------------------------	--	-------------

10. Soldering conditions 半田付条件

Items 項目	Recommended conditions 推奨条件
10.1 Hand soldering 手半田	<p>Please practice according to below conditions. 以下の条件にて実施して下さい。</p> <p>(1) Soldering temperature 半田温度 : <u>350</u> °C Max. (2) Continuous soldering time 連続半田時間 : <u>3</u> s Max. (3) Capacity of soldering iron 半田コテ容量 : <u>60</u> W Max. (4) Excessive pressure shall not be applied to the terminal. 端子に異常加圧のないこと</p>
10.2 Reflow soldering リフロー半田	<p>Please practice according to below conditions. 以下の条件にて実施して下さい。</p> <p>(1) Profile 温度プロファイル</p> <p>Surface of product Temperature 部品表面温度(°C)</p> <p>Time inside soldering equipment 炉内通過時間</p> <p>(2) Allowable soldering time 半田回数 : <u>2</u> time Max. (The temperature shall go down to a normal temperature in prior to exposure to the second time : 2回目を行う場合には、スイッチが常温に戻ってから行うこと。)</p>
10.3 Other precautions For soldering 半田付けに関する その他注意事項	<p>(1) Switch terminals and PCB. Upper face shall be free from flux prior to soldering. 事前にスイッチの端子及びプリント基板の部品実装面上にフラックスが塗られていないこと。</p> <p>(2) Following the soldering process, do not try to clean the switch with a solvent or the like. 半田付け後、溶剤などでスイッチを洗浄しないで下さい。</p> <p>(3) Recommended cream solder : M705-GRN360-K2 (SENJU METAL INDUSTRY CO.,LTD) or equivalent 推奨クリーム半田 : 千住金属工業(株) M705-GRN360-K2 同等品</p> <p>(4) When chip components is soldered on the back side of PCB by automatic flow soldering, after this switch soldered by reflow soldering, flux will possibly creep up at the exterior wall of the housing and penetrate into the housing due to flux ejection. Therefore, when the PCB is designed, please do not locate through holes adjacent to the switch mounted area. 本スイッチをリフロー半田後、プリント基板裏面をディップ半田して使用する場合は、ディップ時のフラックス吹き上げ等によりスイッチ側面からフラックスがはい上がる場合がありますので、パターン設計にあたってはスイッチ下面、周囲にスルーホールを設けないで下さい。</p> <p>(5) As the conditions vary somehow depending on the kind of reflow soldering equipment, please make sure you have the right one before use. リフロー槽の種類により、多少条件が異なりますので、事前に十分確認の上使用してください。</p> <p>(6) As the click rate may deteriorate when heat is applied repeatedly, reflow soldering should be performed in the shortest period and at the lowest temperature possible. 熱履歴が加わるとクリック感が低下する可能性がありますので極力低温短時間でリフローを行うようにお願いします。</p> <p>(7) Safeguard the switch assembly against flux penetration from its top side. スイッチの上面からフラックスが浸入しないようにして下さい。</p> <p>(8) The thickness of cream solder : <u>0.15</u> to <u>0.2</u> mm クリーム半田印刷厚 : <u>0.15</u> ~ <u>0.2</u> mm</p>

DOCUMENT No. KRB-708	TITLE 製品仕様書	PRODUCT SPECIFICATIONS	PAGE 5/6
-------------------------	----------------	------------------------	-------------

【Precaution in use】ご使用上の注意

A. General 一般項目

A1. This product has been designed and manufactured for general electronic devices, such as audio devices, visual devices, home electronics, information devices and communication devices. In case this product is used for more sophisticated equipment requiring higher safety and reliability, such as life support system, space & aviation devices, disaster prevention & security system, please make verification of conformity or check on us for the details.
本製品はオーディオ機器、映像機器、家電機器、情報機器、通信機器などの一般電子機器用に設計・製造したものです。
生命維持装置、宇宙・航空機器、防災・防犯機器などの高度な安全性や信頼性が求められる用途に使用される場合は、貴社にて適合性の確認を頂か、当社へご確認ください。

A2. This product is designed and manufactured assuming that it is to be used with the resistance for direct current.
If you use other kinds of resistance (inductive (L) or capacitive (C)), please let us know beforehand.
本製品は直流の抵抗負荷を想定して設計・製造されています。その他の負荷(誘導性負荷(L)、容量性負荷(C))で使用される場合は、別途ご相談ください。

B. Soldering and assemble to PC board process 半田付、基板実装工程

B1. Note that if the load is applied to the terminals during soldering they might suffer deformation and defects in electrical performance.
端子をはんだ付けされる場合、端子に荷重が加わりますと条件によりガタ、変形及び電気的特性劣化のおそれがありますのでご注意ください。

B2. Conditions of soldering shall be confirmed under actual production conditions.
はんだ付けの条件の設定については、実際の量産条件で確認されるようお願いいたします。

B3. If the switch is given stress from the side, it may result in damages to switch functions. Therefore please handle it with extreme care.
When the switch is carried, any shock shall not be applied to the switch.
スイッチに横からの力が加わりますと、スイッチの機能破壊につながる危険性がありますので取扱いは十分注意して下さい。
移動する場合はスイッチに衝撃が加わらない様に注意して下さい。

B4. As this TACT switch is designed for reflow soldering, if you place it at the edge of PCB for convenience, then flux may get into the sliding part of the SW during automatic dip soldering after being mounted, so do not apply auto dip after being mounted.
当タクトスイッチはリフロー半田対応ですが、スイッチ実装後にオートディップを行う場合にスイッチが基板の端にあるとフラックスが浸入する恐れがありますので十分にご注意下さい。

B5. As the click rate may deteriorate when heat is applied repeatedly, reflow soldering should be performed in the shortest period and at the lowest temperature possible.
熱履歴が加わるとクリック感が低下する可能性がありますので極力低温短時間でリフローを行う様にお願いします。

B6. Please be careful, especially when you use any other type of solder except recommended one.
推奨以外の半田をご使用の際は十分にご注意願います。

C. Washing process 洗浄工程

C1. Following the soldering process, do not try to clean the switch with a solvent or the like.
半田付け後、溶剤等でスイッチを洗浄しないでください。

D. Mechanism design (switch layout) 機構設計

D1. The dimensions of a hole and pattern for mounting a printed circuit board shall refer to the recommended dimensions in the engineering drawings.
プリント基板取付穴及びパターンは、製品図に記載されている推奨寸法をご参照下さい。

D2. You may dip-solder chip components on the backside of PCB after you have reflow-soldered this switch. However, dip-soldering may cause flux to creep up on the wall of the housing and penetrate the switch. Therefore, do not design a through-hole under and around the switch.
本スイッチをリフロー半田後、プリント基板裏面をディップ半田して使用する場合は、ディップ時のフラックス吹き上げ等により、スイッチ側面より、フラックスがはい上がる場合がありますので、パターン設計にあたっては、スイッチ下面、周囲にスルーホールを設けないで下さい。

D3. Do not push except the Actuating area.
操作位置以外を打鍵しないで下さい。

D4. Share of Keying tip: 打鍵部先端形状
The tip of the keying section of a flat-stem-type switch should be designed as follows:
キートップの打鍵部先端形状は次の様に設計して下さい。

It is recommended that tip of the keying section is flat ($\phi 1.2\text{mm}$, R0.2)
打鍵部先端形状: $\phi 1.2\text{mm}$, R0.2の円柱形状を推奨します。

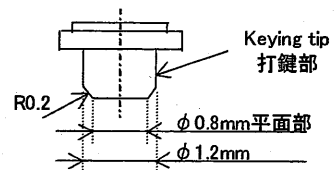

D5. Restriction in operation: 操作条件
Restriction in operation: Allowable misalignment between the center of the switch and the center of keying section is 0.4mm max.
スイッチ外形を基準とする中心軸線から打鍵部中心軸線間のセンターズレは、0.4mm以下にて御使用下さい。
Allowable inclination of keying section: 90 \pm 3 degrees or less.
打鍵部中心軸線の傾きは、90 \pm 3度以内に設定して下さい。

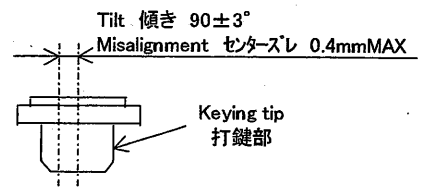

D6. This switch is designed for unit construction that it is pressed by human operation.
Please avoid using this switch as mechanical detecting function.
In case such detecting function is required, please consult with our detector switch section.
当スイッチは、直接人の操作を介してスイッチを押す構造にてご使用下さい。
メカ的な検出機能へのご使用は、避けてください。
検出機能には弊社検出スイッチをご使用下さい。

D7. Sealing film on the switch shall be free from damages by sharp edged objects.
スイッチのフィルム部分を鋭利なもので押さえることは避けて下さい。

DOCUMENT No. KRB-708	TITLE 製品仕様書	PAGE 6/6
<p>D8. Designing printed pattern and parts layout shall be considered because the characteristics may change due to warp of P.C.B. 基板のソリによって特性が変化することがありますので、パターン設計・レイアウトについては十分考慮願います。</p> <p>D9. The switch will be broken, if you give larger stress than specified. Take most care not to let the switch be given larger stress than specified. (Refer to the strength of the stopper.) スイッチ操作時に規定以上の荷重が加わるとスイッチが破損する場合があります。スイッチに規定荷重以上の力が加わらない様にご注意下さい。 (ストッパー強度参照)</p> <p>D10. If you intend to change the way of the switch being used on your module, please let us know. セット上でのスイッチの使われ方が変更される際は当社に御連絡ください。</p> <p>E. Using environment 使用環境</p> <p>E1. If you use this product in one of the following environmental conditions, progress of sulfuration and oxidization on the contact part will be accelerated, which may cause contact failure. Therefore, be careful about the operation environment. 以下の様な環境下で使用されますと、当製品の性能に影響を及ぼすおそれがありますので使用環境に十分にご注意下さい。</p> <p>(1) Around a sulfurate hot spring where sulfide gas is generated. And in case this product is always used in a place where exhaust gas from automobiles exist. 硫黄系温泉地等常時ガスが発生する場所や自動車等の排気ガスの発生する場所で常時使用する場合</p> <p>(2) Follow the directions if you have parts/materials described below within the module where the switch is installed. 同一セット内に以下の様な部材に關しましては以下の点にご注意願います。</p> <ul style="list-style-type: none"> • For parts, rubber materials, adhesive agents, plywood, packing materials and lubricant used for the mechanical part of the device, do not use those ones that may generate gas of sulfuration or oxidization. 部品、ゴム材料、接着剤、合板、機器の梱包材、機器内の駆動部に使用される潤滑剤については、硫化、酸化ガスが発生しないものを採用してください。 • When you use silicon rubber, grease, adhesive agents and oil, use those that will not generate low molecular siloxane gas. The low molecular siloxane gas may form silicon dioxide coat on the SW contact part, resulting in the contact failure. シリコン系ゴム、グリース、接着剤、オイルを使用される場合は、低分子シロキサンガスが発生しないものを使用してください。低分子シロキサンガスが発生しますとSW接点部に2酸化珪素の被膜を形成して接点障害を引き起こす場合があります。 <p>(3) When you apply chemical agents such as coating agents to the products, please let us know beforehand. 製品のコーティング剤等の薬品を付着させる場合は、別途ご相談ください。</p> <p>E2. Do not use this switch in the atmosphere with high humidity or with bedewing probability, because such atmosphere may cause leak among terminals. 高湿度環境下、又は結露する可能性がある環境では、端子間の電流リークが発生する可能性がありますので本スイッチはご使用にならないでください。</p> <p>F. Storage method. 保管方法</p> <p>F1. If you don't use the product immediately, store it as delivered in the following environment: with neither direct sunshine nor corrosive gas and in normal temperatures. However, it is recommended that you should use it as soon as possible before six months pass. 製品は納入形態のまま常温、常湿で直射日光の当たらず腐食性ガスが発生しない場所に保管し納入から6ヶ月以内を限度として出来るだけ早くご使用ください。</p> <p>F2. After you break the seal, you should put the remaining in a plastic bag to separate it from the outside and store it in the same environment mentioned above. You should use it up as soon as possible. 開封後はポリフクロで外気との遮断を図り上記と同じ環境下で保管すみやかにご使用下さい。</p> <p>F3. Do not stack too many switches for strafe. 過剰な積み重ねは行わないで下さい。</p> <p>G. Others. その他</p> <p>G1. This specification will be invalid one year after it is issued, if you don't return it or don't place an order. 本仕様書は発行日より1年間を経過して、ご返却又はご注文の無い場合は、無効とさせていただきます。</p> <p>G2. Please understand that the specifications other than electric and mechanical characteristics and outside dimensions may be changed at our own discretion. 電氣的、機械的特性、外觀寸法および取付寸法以外につきましては、当社の都合により変更させて頂く事がありますので、あらかじめ御了承下さい。</p> <p>G3. Never use the product beyond the rating. It may catch fire. If you think that the product may be used beyond the rating due to some abnormal conditions, you must take certain protective measures, such as a protective circuit to shut down the current. 定格を超えての使用は火災発生のおそれがありますので絶対に避けて下さい。また異常使用等で定格を超える恐れがある場合は保護回路等で電流遮断等の対策をして下さい。</p> <p>G4. The flammability grade of the plastic used for this product is "94HB" by the UL Standard (slow burning). Therefore, either refrain from using it in the place where it can catch fire, or take measures to preclude catching fire. 本製品に使用している樹脂等の燃焼グレードはUL規格の"94HB"(遅燃性グレード)相当を使用しております。つきましては類焼の恐れがある場所での使用を禁止するか、類焼防止対策をお願いします。</p> <p>G5. Though we are confident in switch quality, we cannot deny the possibility that they could fail due to short or open circuit. Therefore, if you use a switch for a product requiring higher safety level, we would like you to verify in advance what effects your module would receive in case the switch alone should fail. And secure safety as a whole system by introducing the fail-safe design, i.e. a protection network. スイッチの品質には万全を尽くしていますが故障モードとしてショート、オープンの発生が皆無とは言えません。 安全性が重視されるセットの設計に際しては、スイッチの単品故障に対してセットとしての影響を事前にご検討頂き、保護回路等のフェールセーフ設計のご検討を十分に行い安全を確保して頂きますようお願いいたします。</p>		

1. Scope 適用範囲

This specification covers the requirements of the taping packaging for SKRB standard type of TACT switches.

この規格はSKRBタイプ、タクトスイッチのテーピング包装に適用する。

2. Packaging Quantity 包装単位

2.1. The number of the reels. リールの詰め個数

10 reels at maximum, which contain 100,000 switches, shall be packed in a package.

包装箱1箱にMax、10リール(製品100,000個)とする。

2.2. The number of the switches. 1リールの製品数

10,000 switches shall be packed in a reel.

10,000個とする。

~~E1 2.3. It should be noted that we regard 2 cartons mentioned above as on package for export.~~

~~輸出梱包の場合は、上記包装箱2個を持って1包装とする。~~

3. Tape Form and Dimensions テープの形状及び寸法

~~B1~~ ※ The gate position (depression) of this product, there are two types of A side and B side in the below figure.

製品のゲート位置(凹形状)は、下図A側、B側の2通りがあります。

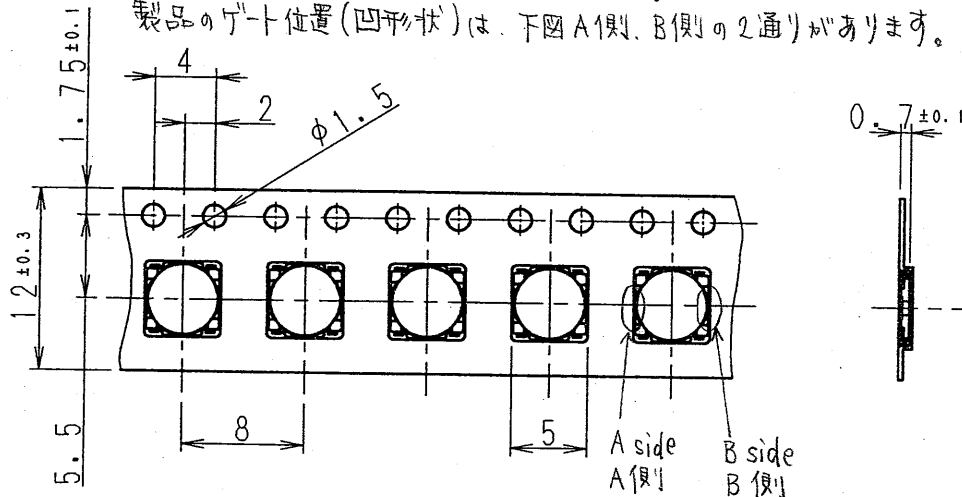

Pulling-out direction of the tape.

テープ引出し方向 →

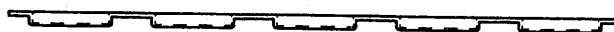

2/2	F4	Jun. 17, 2008	F. Hara	F. Hara	K. Shibakusa	ALPS ELECTRIC CO., LTD.		
1/2	E1	Feb. 14, 2006	T. Miike	H. Noguma	J. Onodera			
3/2	D3	May 13, 2005	T. TSUTSUMI	T. Kato	T. Tsutsumi	APPD.	CHKD.	DSGD.
2/2	C1	May. 28, 2004	TSUTSUMI	T. Kato	K. Nakamura	Jan. 17, 2000	Jan. 17, 2000	Jan. 17, 2000
1/2	B1	Aug. 06, 2001	T. Miike	T. Miike	C. Saito	DS1	DS1	DS1
2/2	A3	Aug. 24, 2000	Y. Ono	K. Kagawa	K. Shibakusa	J. Tsutsumi	J. Tsutsumi	H. Noguma
Page	Symb	Date	APPD.	CHKD.	DSGD.			

4. Reel Form and Dimensions リールの形状及び寸法

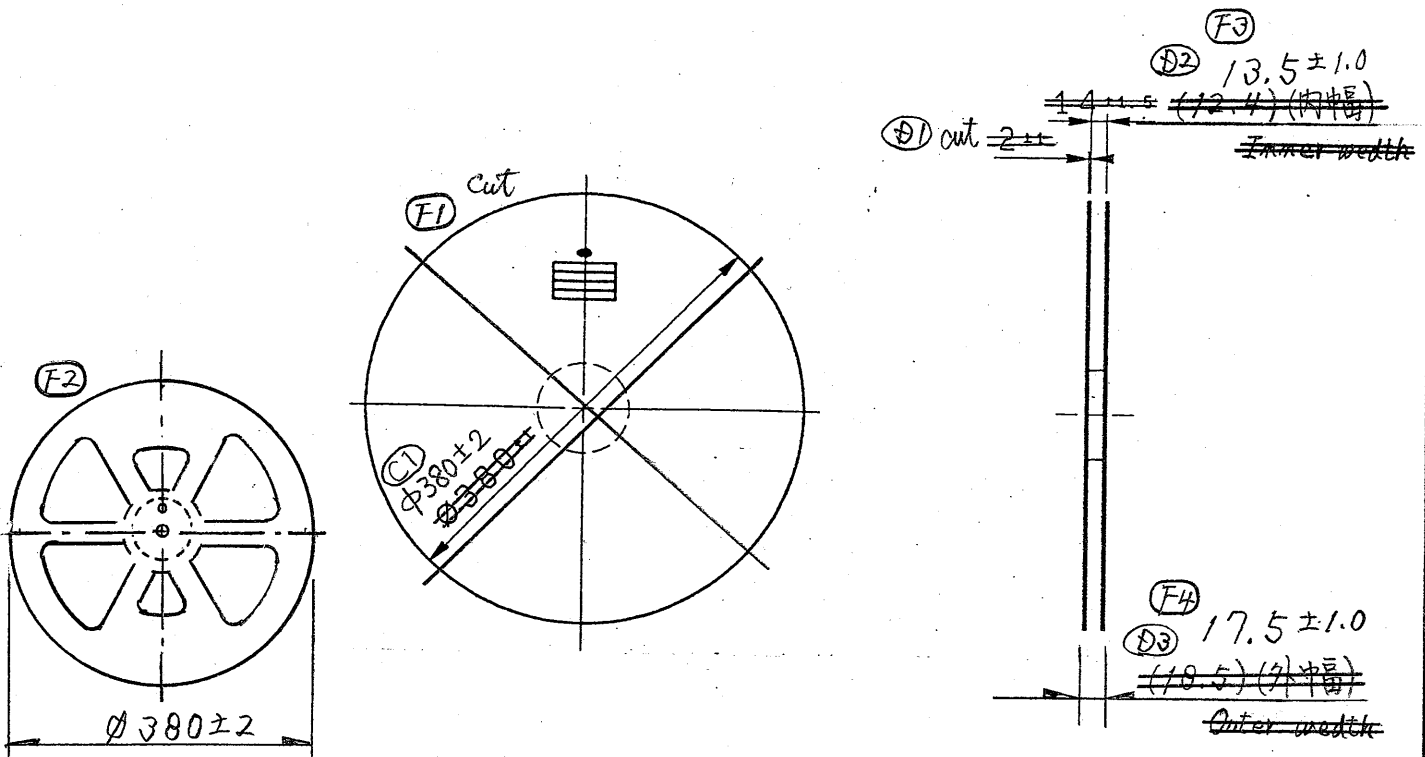

5. Packaging Procedure 包装方法

5.1. At the beginning of reel, the end of the tape, 200 mm or more, shall be empty and fit into the groove in the reel core.

テープの巻き始めは、製品を200 mm以上取り除き、リール軸芯の溝にはめこんで止める。

5.2. After reeling, the end of the tape, 15 or more, shall be empty and the tape edge shall be cut in 45°.

The cover tape shall be extended 400 mm or more from the tape edge and fixed with tape.

テープ巻き終わりは、空エンボスを15以上含み、400 mm以上空巻きしテープを止める。又、キャリアテープの先端は、両端を45°にカットする。

5.3. Total number of missing switches shall be ~~less than 10~~ ^{(A1) 0} in one reel.

(A2) Cut ~~(Three consecutive switches may be missing.)~~

製品の欠落は1リール10個以下のこと。(但し、連続欠落は、3個以下のこと。)

(A3) 0個とする。

6. Storage Condition 保存条件

6.1. Storage Environment 保存環境

-20 to 50 °C, 20 to 85 % RH.

(Storage in high temperature and high humidity shall be avoided.)

-20 ~ 50 °C、20 ~ 85 % RH以内 (高温多湿での保存は避けること。)

6.2. Storage Period 保存期間

Maximum of 6 months after the date of delivery.

出荷後6ヶ月以内。