

**0900-0**

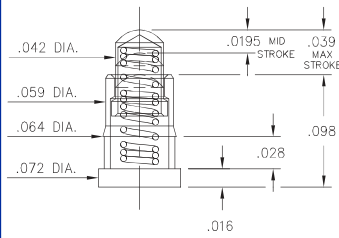

**0900-0-15-20-76-14-11-0**  
"Legacy P/N 0900-0-00-00-00-00-11-0"  
Short Stroke, Surface mount  
Lowest profile

**0900-1⇒4,8**

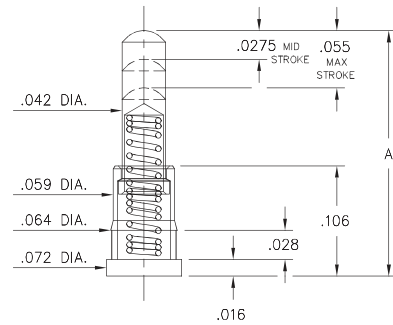

**0900-X-15-20-75-14-11-0**  
"Legacy P/N 0900-X-00-00-00-00-11-0"  
Standard Stroke, Surface mount

Basic Part Number	Length A
0900-1	.177
0900-2	.197
0900-3	.217
0900-4	.236
*0900-8	.155

\*0900-8 has a .0195" Mid. Stroke & .039" Max. Stroke  
Order as:  
0900-8-15-20-76-14-11-0

**0934**

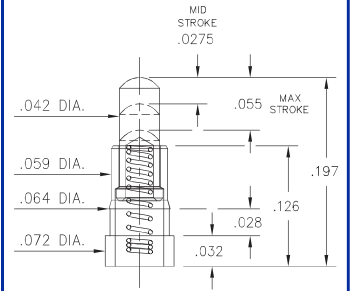

**0934-0-15-20-74-14-26-0**  
Standard Stroke  
Surface mount

**0936**

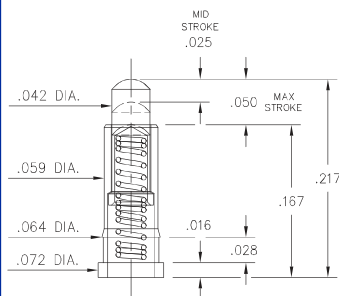

**0936-0-15-20-75-14-11-0**  
Standard Stroke  
Surface mount

**0928**

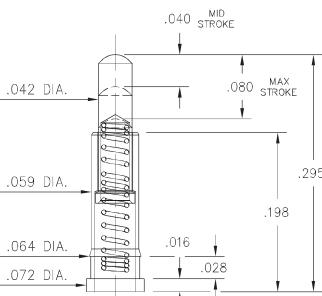

**0928-0-15-20-77-14-11-0**  
Long Stroke  
Surface mount

**0907-0⇒9**

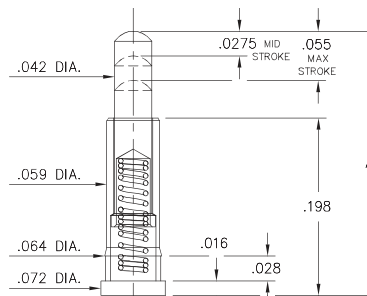

**0907-X-15-20-75-14-11-0**  
Standard Stroke, Surface mount  
High profile

Basic Part Number	Length A
0907-0	.255
0907-1	.275
0907-2	.295
0907-3	.315
0907-4	.335
0907-5	.350
0907-6	.370
0907-7	.390
0907-8	.410
0907-9	.430

**0913**

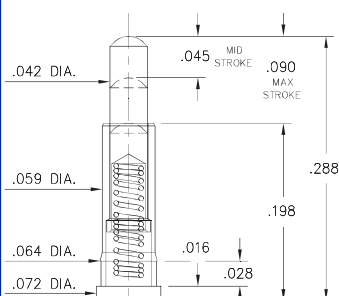

**0913-0-15-20-77-14-11-0**  
Long Stroke  
Surface mount

**0925**

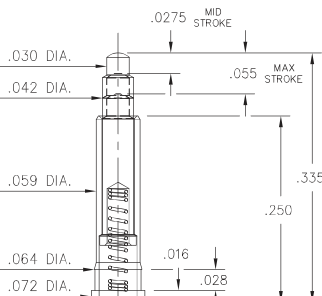

**0925-0-15-20-73-14-26-0**  
Standard Stroke  
Surface mount

**0927**

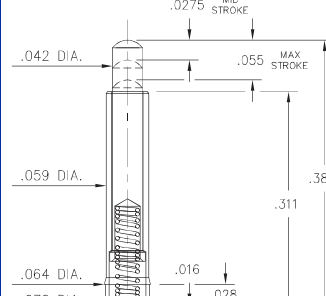

**0927-0-15-20-75-14-11-0**  
Standard Stroke  
Surface mount

**0905**

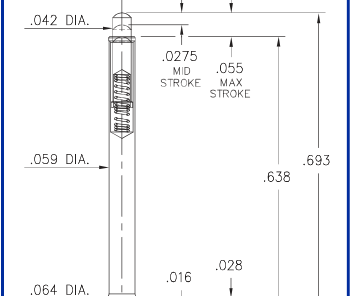

**0905-0-15-20-75-14-11-0**  
"Legacy P/N 0905-0-00-00-00-00-11-0"  
Standard Stroke, Surface mount

**ORDER CODE: 09XX - X - 15 - 20 - 7X - 14 - XX - 0**

Spring Number

**MATERIAL SPECIFICATIONS:**

- SLEEVE & PLUNGER MATERIAL:** Copper Alloy
- SPRING MATERIAL:** Beryllium Copper
- SLEEVE & PLUNGER FINISH:** 20 μ" Gold over Nickel
- SPRING FINISH:** 10 μ" Gold over Nickel
- DIMENSION IN INCHES:**
- TOLERANCES ON:** LENGTHS: ±.006  
DIAMETERS: ±.002  
ANGLES: ± 2°



**MECHANICAL & ELECTRICAL SPECIFICATIONS:**

- DURABILITY:** 1,000,000 cycles
- CURRENT RATING:** 2A continuous, 3A peak
- CONTACT RESISTANCE:** 20 mΩ max.

SPRING NUMBER	Mid. STROKE	Max. STROKE	FORCE @ Mid. Stroke	Initial Force (Pre-load)
73	.0275	.055	60 g	25 g
74	.0275	.055	50 g	15 g
75	.0275	.055	60 g	25 g
76	.0195	.039	60 g	25 g
77	.045	.090	60 g	25 g

73, 74, 75, 76, 77 Springs are not Interchangeable