

Trench gate field-stop IGBT, M series 1200 V, 8 A low-loss

Datasheet - production data

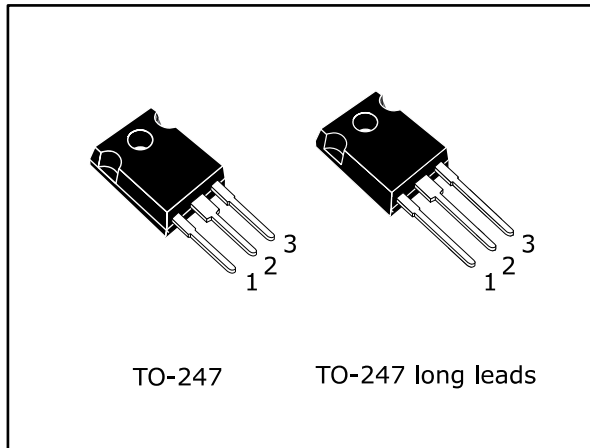
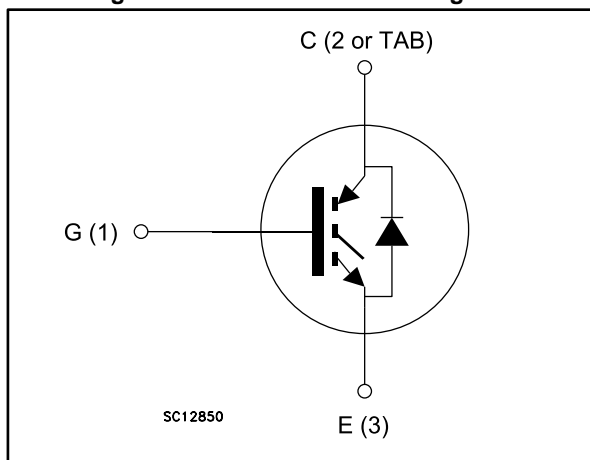

Figure 1: Internal schematic diagram



Features

- 10 μ s of short-circuit withstand time
- $V_{CE(sat)} = 1.85$ V (typ.) @ $I_C = 8$ A
- Tight parameter distribution
- Safer paralleling
- Low thermal resistance
- Soft and very fast recovery antiparallel diode

Applications

- Industrial drives
- UPS
- Solar
- Welding

Description

These devices are IGBTs developed using an advanced proprietary trench gate field-stop structure. These devices are part of the M series IGBTs, which represent an optimal balance between inverter system performance and efficiency where low-loss and short-circuit functionality are essential. Furthermore, the positive $V_{CE(sat)}$ temperature coefficient and tight parameter distribution result in safer paralleling operation.

Table 1: Device summary

| Order code | Marking | Package | Packing |
|---------------|-----------|-------------------|---------|
| STGW8M120DF3 | G8M120DF3 | TO-247 | Tube |
| STGWA8M120DF3 | | TO-247 long leads | |

Contents

| | | |
|----------|---|-----------|
| 1 | Electrical ratings | 3 |
| 2 | Electrical characteristics | 4 |
| | 2.1 Electrical characteristics (curves) | 7 |
| 3 | Test circuits | 12 |
| 4 | Package information | 13 |
| | 4.1 TO-247 package information | 13 |
| | 4.2 TO-247 long leads package information | 15 |
| 5 | Revision history | 17 |

1 Electrical ratings

Table 2: Absolute maximum ratings

| Symbol | Parameter | Value | Unit |
|----------------|--|-------------|------|
| V_{CES} | Collector-emitter voltage ($V_{GE} = 0$ V) | 1200 | V |
| I_C | Continuous collector current at $T_C = 25$ °C | 16 | A |
| I_C | Continuous collector current at $T_C = 100$ °C | 8 | A |
| $I_{CP}^{(1)}$ | Pulsed collector current | 32 | A |
| V_{GE} | Gate-emitter voltage | ± 20 | V |
| I_F | Continuous forward current at $T_C = 25$ °C | 16 | A |
| I_F | Continuous forward current at $T_C = 100$ °C | 8 | A |
| $I_{FP}^{(1)}$ | Pulsed forward current | 32 | A |
| P_{TOT} | Total dissipation at $T_C = 25$ °C | 167 | W |
| T_{STG} | Storage temperature range | - 55 to 150 | °C |
| T_J | Operating junction temperature range | - 55 to 175 | °C |

Notes:

⁽¹⁾Pulse width limited by maximum junction temperature.

Table 3: Thermal data

| Symbol | Parameter | Value | Unit |
|------------|--|-------|------|
| R_{thJC} | Thermal resistance junction-case IGBT | 0.9 | °C/W |
| R_{thJC} | Thermal resistance junction-case diode | 1.47 | °C/W |
| R_{thJA} | Thermal resistance junction-ambient | 50 | °C/W |

2 Electrical characteristics

$T_C = 25\text{ °C}$ unless otherwise specified

Table 4: Static characteristics

| Symbol | Parameter | Test conditions | Min. | Typ. | Max. | Unit |
|---------------|--------------------------------------|--|------|------|-----------|---------------|
| $V_{(BR)CES}$ | Collector-emitter breakdown voltage | $V_{GE} = 0\text{ V}$, $I_C = 2\text{ mA}$ | 1200 | | | V |
| $V_{CE(sat)}$ | Collector-emitter saturation voltage | $V_{GE} = 15\text{ V}$, $I_C = 8\text{ A}$ | | 1.85 | 2.3 | V |
| | | $V_{GE} = 15\text{ V}$, $I_C = 8\text{ A}$, $T_J = 125\text{ °C}$ | | 2.1 | | |
| | | $V_{GE} = 15\text{ V}$, $I_C = 8\text{ A}$, $T_J = 175\text{ °C}$ | | 2.2 | | |
| V_F | Forward on-voltage | $I_F = 8\text{ A}$ | | 2.4 | 3.35 | V |
| | | $I_F = 8\text{ A}$, $T_J = 125\text{ °C}$ | | 1.75 | | |
| | | $I_F = 8\text{ A}$, $T_J = 175\text{ °C}$ | | 1.55 | | |
| $V_{GE(th)}$ | Gate threshold voltage | $V_{CE} = V_{GE}$, $I_C = 500\text{ }\mu\text{A}$ | 5 | 6 | 7 | V |
| I_{CES} | Collector cut-off current | $V_{CE} = 1200\text{ V}$ | | | 25 | μA |
| I_{GES} | Gate-emitter leakage current | $V_{GE} = \pm 20\text{ V}$ | | | ± 250 | μA |

Table 5: Dynamic characteristics

| Symbol | Parameter | Test conditions | Min. | Typ. | Max. | Unit |
|-----------|------------------------------|---|------|------|------|------|
| C_{ies} | Input capacitance | $V_{CE} = 25\text{ V}$, $f = 1\text{ MHz}$, $V_{GE} = 0\text{ V}$ | - | 542 | - | pF |
| C_{oes} | Output capacitance | | - | 74.4 | - | |
| C_{res} | Reverse transfer capacitance | | - | 21 | - | |
| Q_g | Total gate charge | $V_{CC} = 960\text{ V}$, $I_C = 8\text{ A}$, $V_{GE} = 15\text{ V}$ (see Figure 30: "Gate charge test circuit") | - | 32 | - | nC |
| Q_{ge} | Gate-emitter charge | | - | 4.5 | - | |
| Q_{gc} | Gate-collector charge | | - | 18.5 | - | |

Table 6: IGBT switching characteristics (inductive load)

| Symbol | Parameter | Test conditions | Min. | Typ. | Max. | Unit |
|-----------------|------------------------------|--|------|------|------|------------|
| $t_{d(on)}$ | Turn-on delay time | $V_{CE} = 600\text{ V}$, $I_C = 8\text{ A}$, $V_{GE} = 15\text{ V}$, $R_G = 33\ \Omega$ (see Figure 29 : "Test circuit for inductive load switching") | | 20 | - | ns |
| t_r | Current rise time | | | 8.4 | - | ns |
| $(di/dt)_{on}$ | Turn-on current slope | | | 800 | - | A/ μ s |
| $t_{d(off)}$ | Turn-off-delay time | | | 126 | - | ns |
| t_f | Current fall time | | | 136 | - | ns |
| $E_{on}^{(1)}$ | Turn-on switching energy | | | 0.39 | - | mJ |
| $E_{off}^{(2)}$ | Turn-off switching energy | | | 0.37 | - | mJ |
| E_{ts} | Total switching energy | | | 0.76 | - | mJ |
| $t_{d(on)}$ | Turn-on delay time | $V_{CE} = 600\text{ V}$, $I_C = 8\text{ A}$, $V_{GE} = 15\text{ V}$, $R_G = 33\ \Omega$ $T_J = 175\text{ }^\circ\text{C}$ (see Figure 29 : "Test circuit for inductive load switching") | | 19 | - | ns |
| t_r | Current rise time | | | 9.8 | - | ns |
| $(di/dt)_{on}$ | Turn-on current slope | | | 656 | - | A/ μ s |
| $t_{d(off)}$ | Turn-off-delay time | | | 134 | - | ns |
| t_f | Current fall time | | | 222 | - | ns |
| $E_{on}^{(1)}$ | Turn-on switching energy | | | 0.66 | - | mJ |
| $E_{off}^{(2)}$ | Turn-off switching energy | | | 0.58 | - | mJ |
| E_{ts} | Total switching energy | | | 1.24 | - | mJ |
| t_{sc} | Short-circuit withstand time | $V_{CC} \leq 600\text{ V}$, $V_{GE} = 15\text{ V}$, $T_{Jstart} \leq 150\text{ }^\circ\text{C}$ | 10 | | - | μ s |

Notes:⁽¹⁾Including the reverse recovery of the diode.⁽²⁾Including the tail of the collector current.

Table 7: Diode switching characteristics (inductive load)

| Symbol | Parameter | Test conditions | Min. | Typ. | Max. | Unit |
|--------------|--|--|------|------|------|------------------------|
| t_{rr} | Reverse recovery time | $I_F = 8\text{ A}$, $V_R = 600\text{ V}$, $V_{GE} = 15\text{ V}$, $R_G = 33\ \Omega$ ($di/dt = 1000\text{ A}/\mu\text{s}$) (see Figure 29 : "Test circuit for inductive load switching") | - | 103 | - | ns |
| Q_{rr} | Reverse recovery charge | | - | 0.87 | - | μC |
| I_{rrm} | Reverse recovery current | | - | 19.2 | - | A |
| dl_{rr}/dt | Peak rate of fall of reverse recovery current during t_b | | - | 720 | - | $\text{A}/\mu\text{s}$ |
| E_{rr} | Reverse recovery energy | | - | 211 | - | μJ |
| t_{rr} | Reverse recovery time | $I_F = 8\text{ A}$, $V_R = 600\text{ V}$, $V_{GE} = 15\text{ V}$, $T_J = 175\text{ }^\circ\text{C}$, $R_G = 33\ \Omega$ ($di/dt = 840\text{ A}/\mu\text{s}$) (see Figure 29 : "Test circuit for inductive load switching") | - | 280 | - | ns |
| Q_{rr} | Reverse recovery charge | | - | 1.9 | - | μC |
| I_{rrm} | Reverse recovery current | | - | 21.8 | - | A |
| dl_{rr}/dt | Peak rate of fall of reverse recovery current during t_b | | - | 450 | - | $\text{A}/\mu\text{s}$ |
| E_{rr} | Reverse recovery energy | | - | 404 | - | μJ |

2.1 Electrical characteristics (curves)

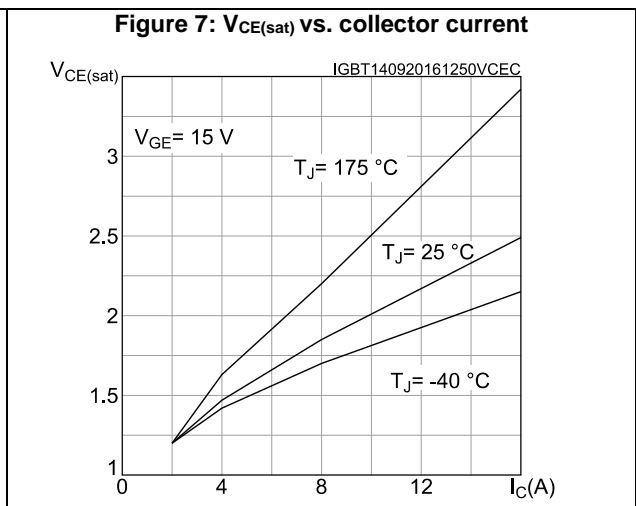
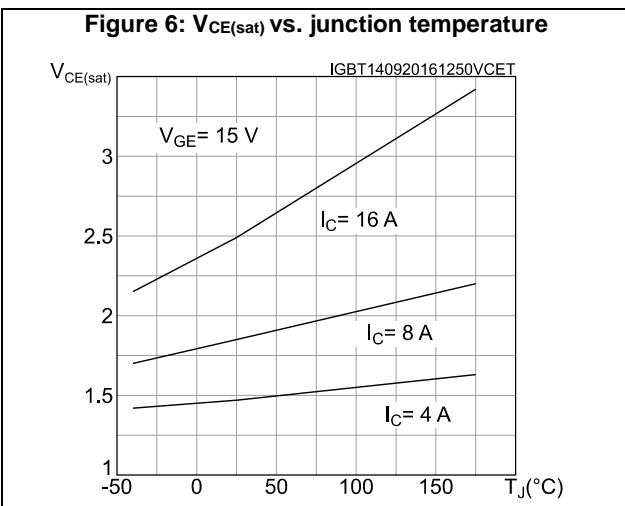
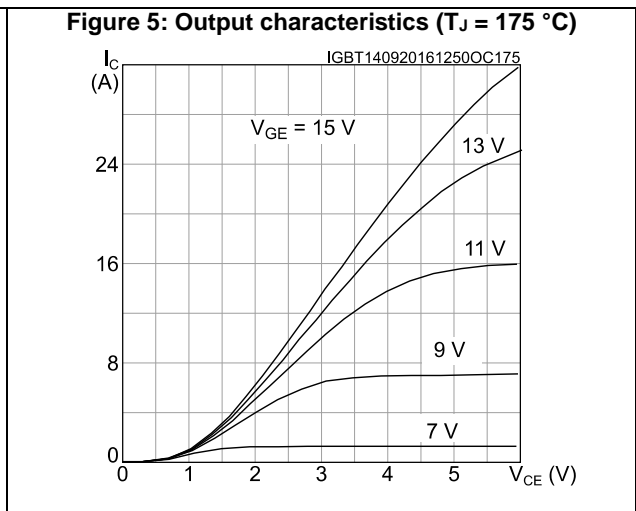
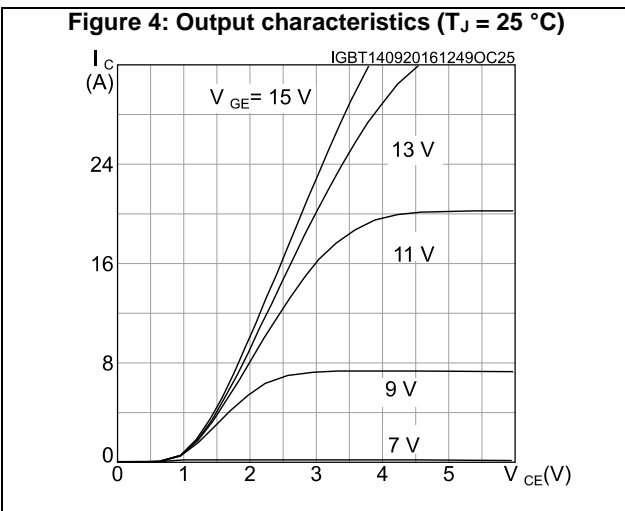
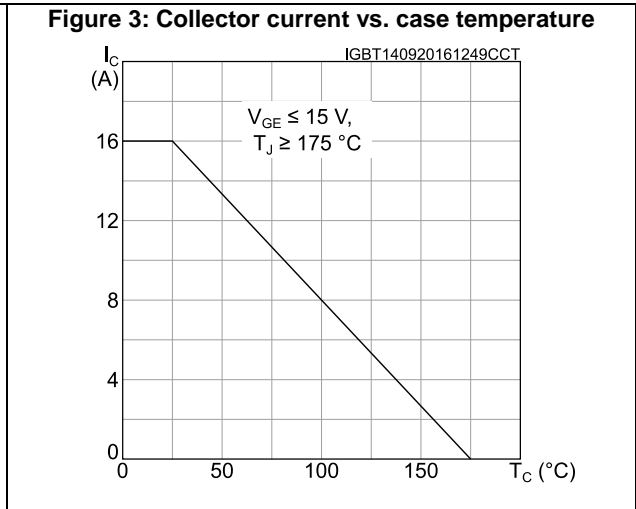
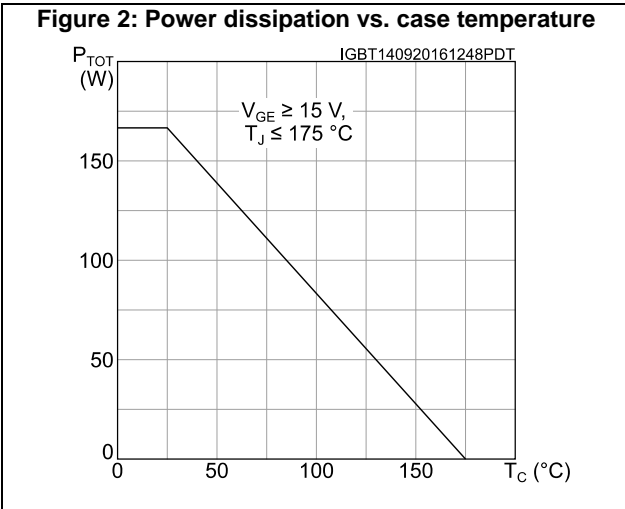

Electrical characteristics

STGW8M120DF3, STGWA8M120DF3

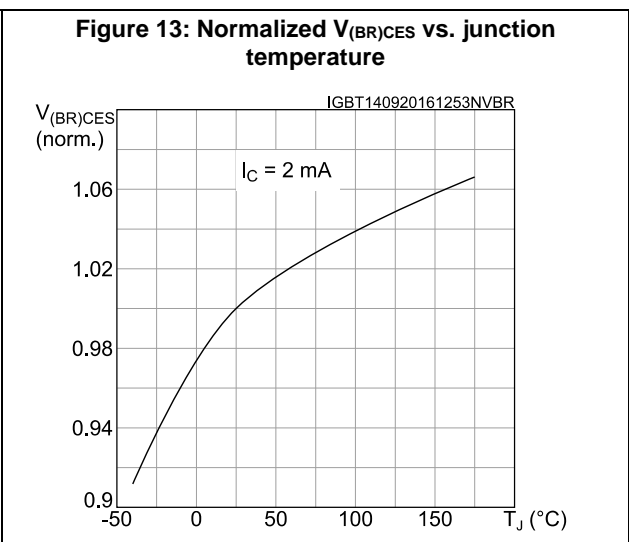
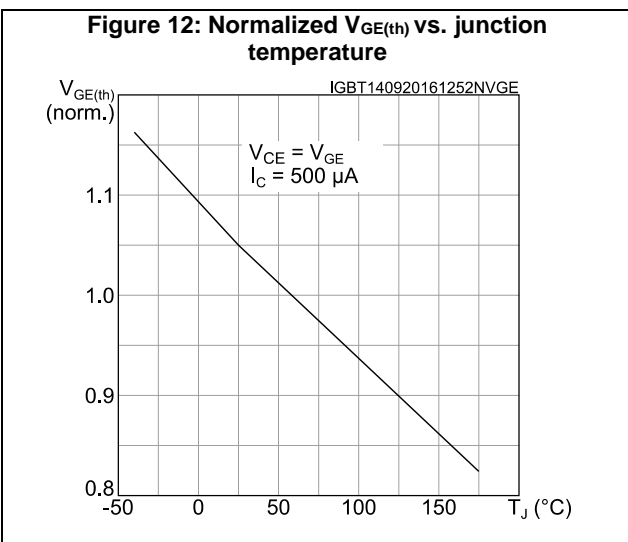
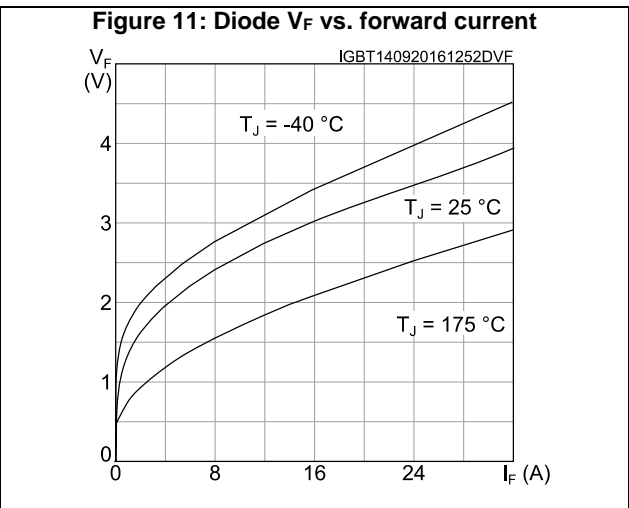
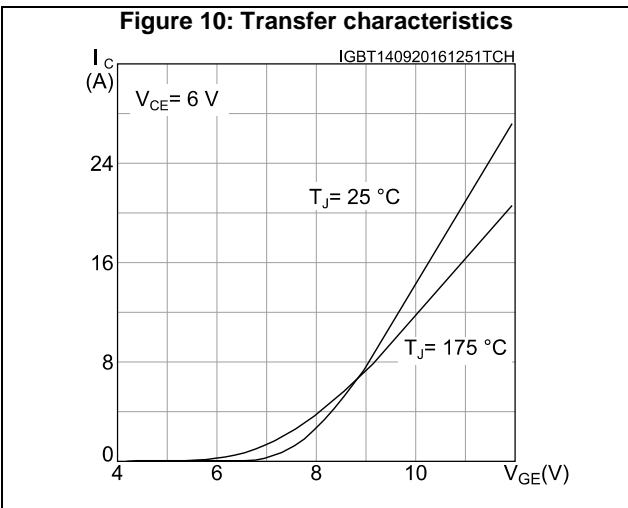
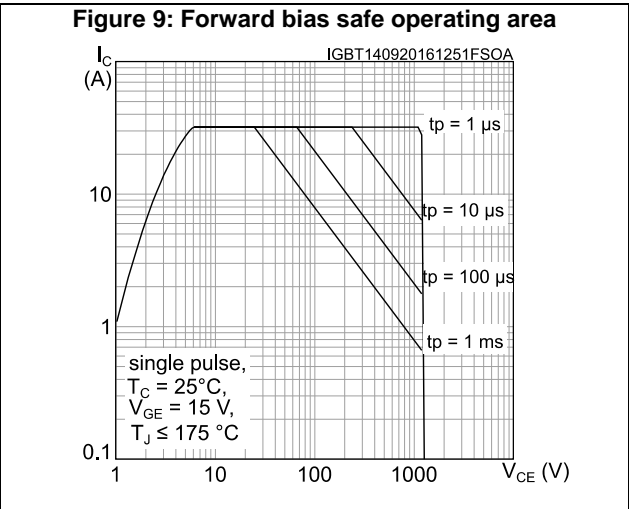
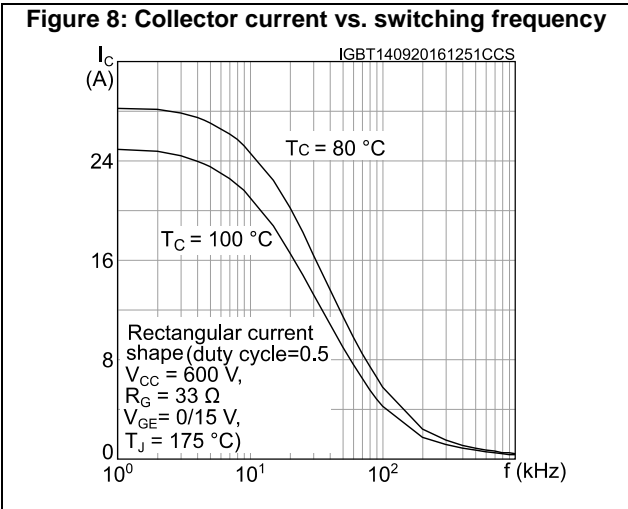

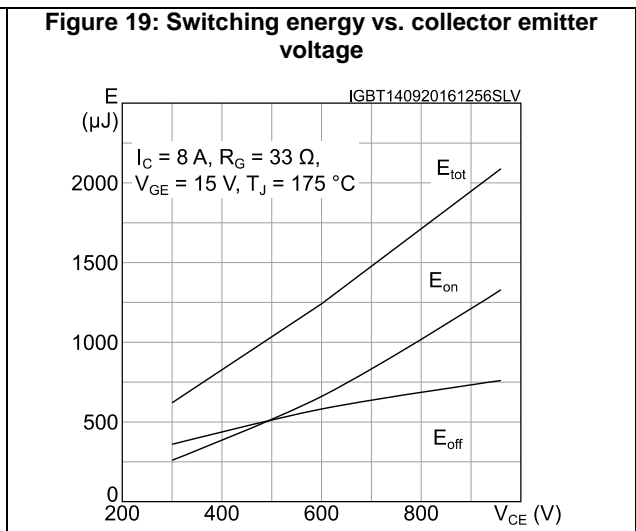
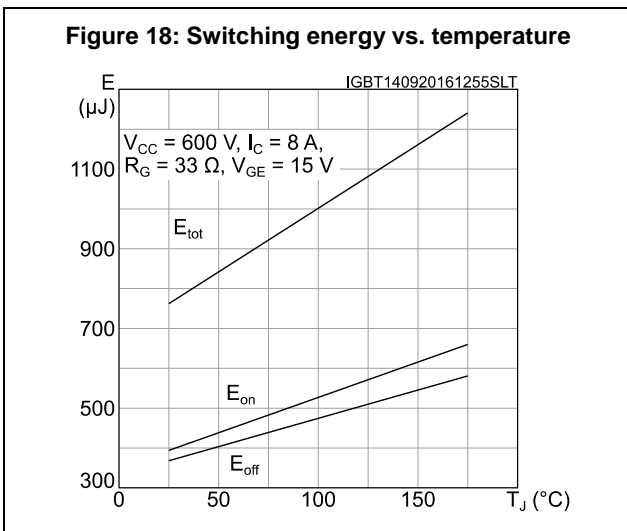
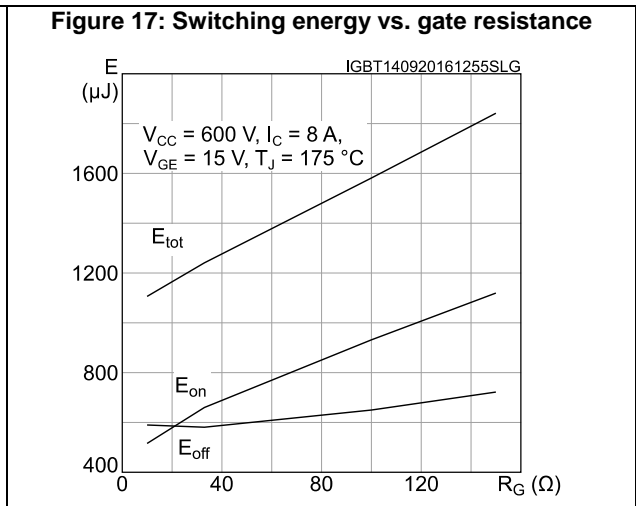
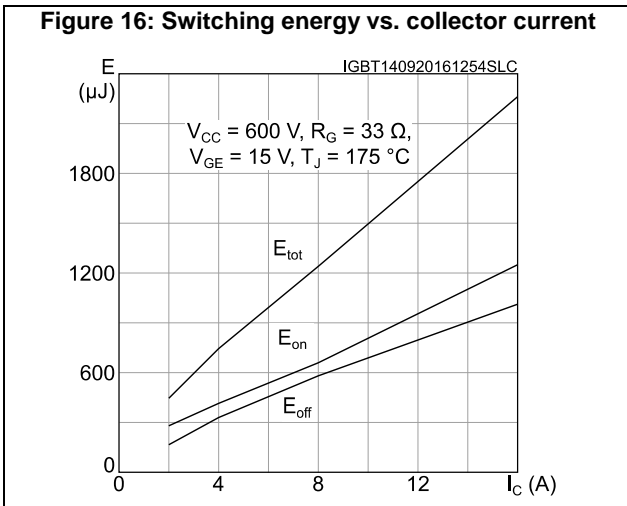
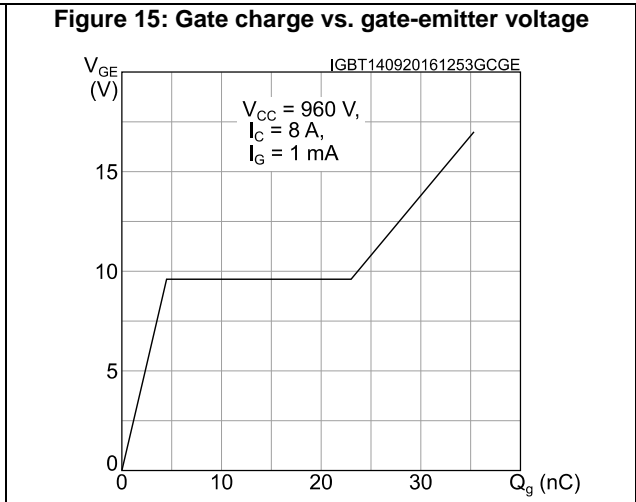
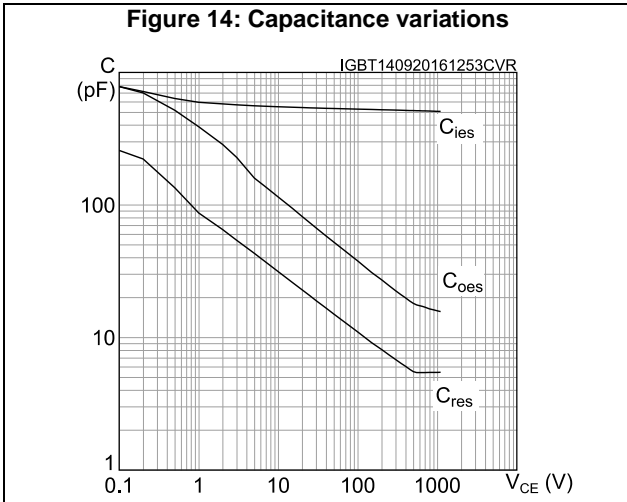

Electrical characteristics

STGW8M120DF3, STGWA8M120DF3

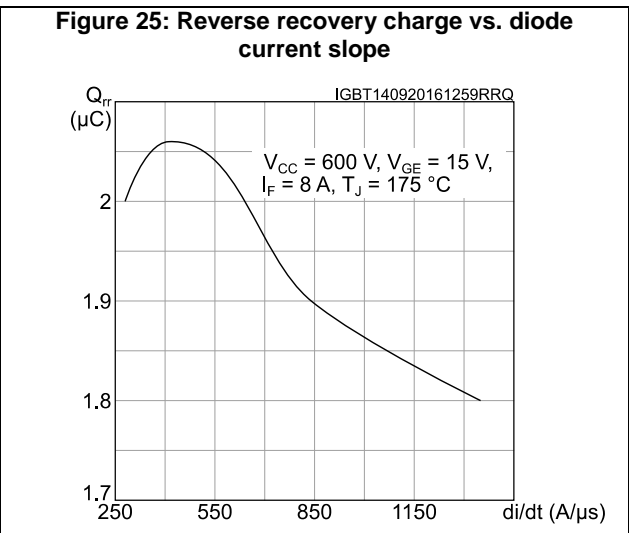
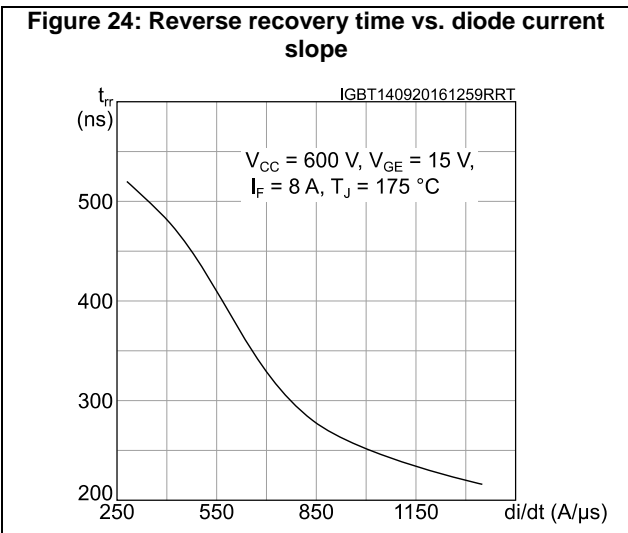
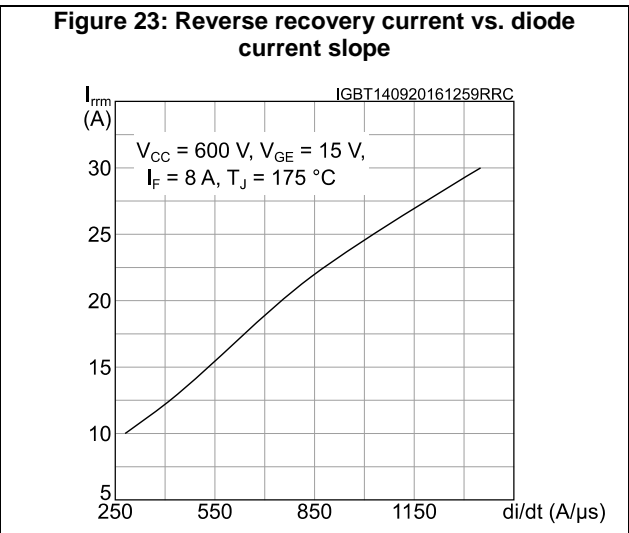
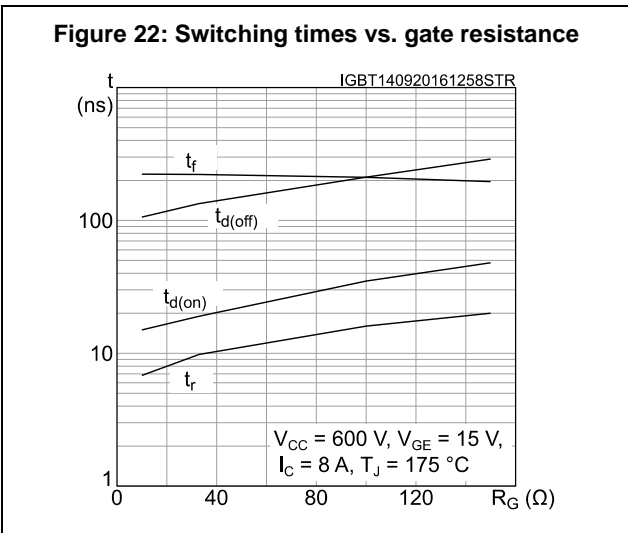
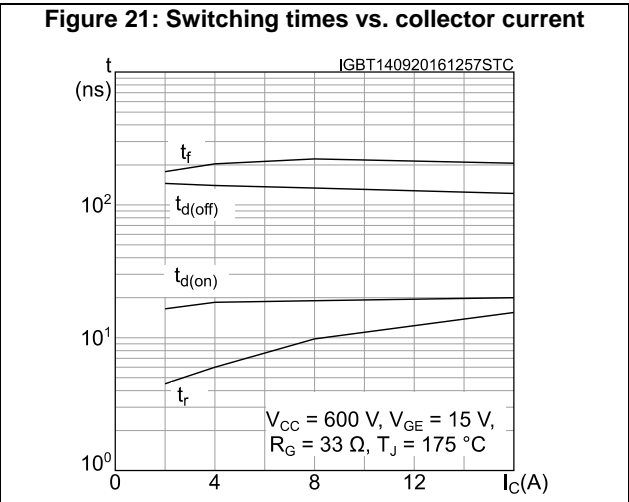
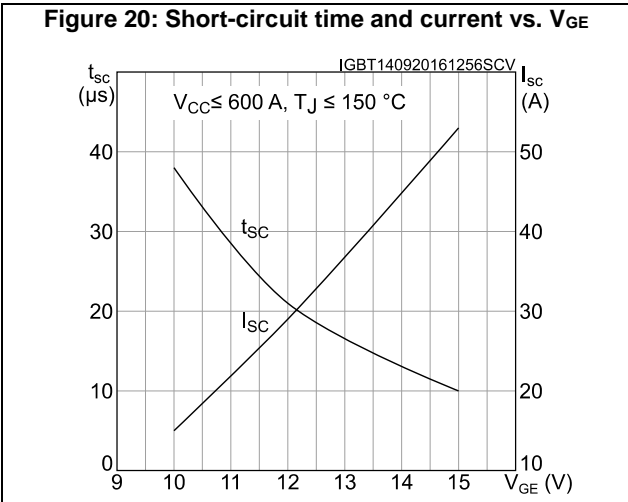

Figure 26: Reverse recovery energy vs. diode current slope

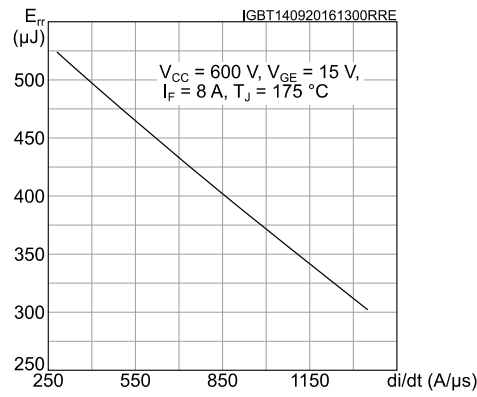

Figure 27: Thermal impedance for IGBT

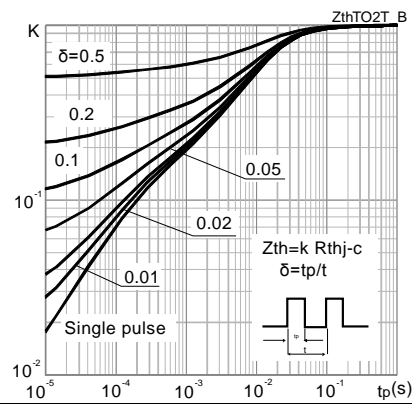
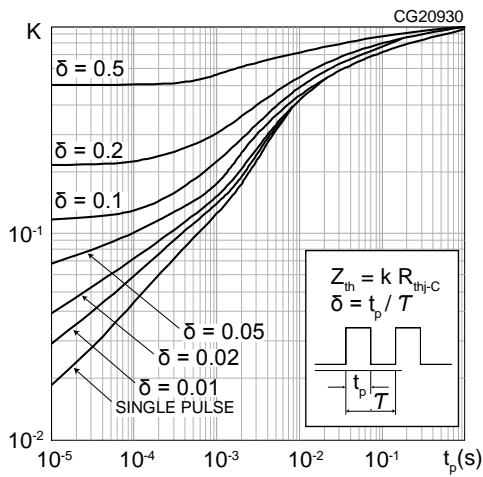

Figure 28: Thermal impedance for diode



4 Package information

In order to meet environmental requirements, ST offers these devices in different grades of ECOPACK® packages, depending on their level of environmental compliance. ECOPACK® specifications, grade definitions and product status are available at: www.st.com. ECOPACK® is an ST trademark.

4.1 TO-247 package information

Figure 33: TO-247 package outline

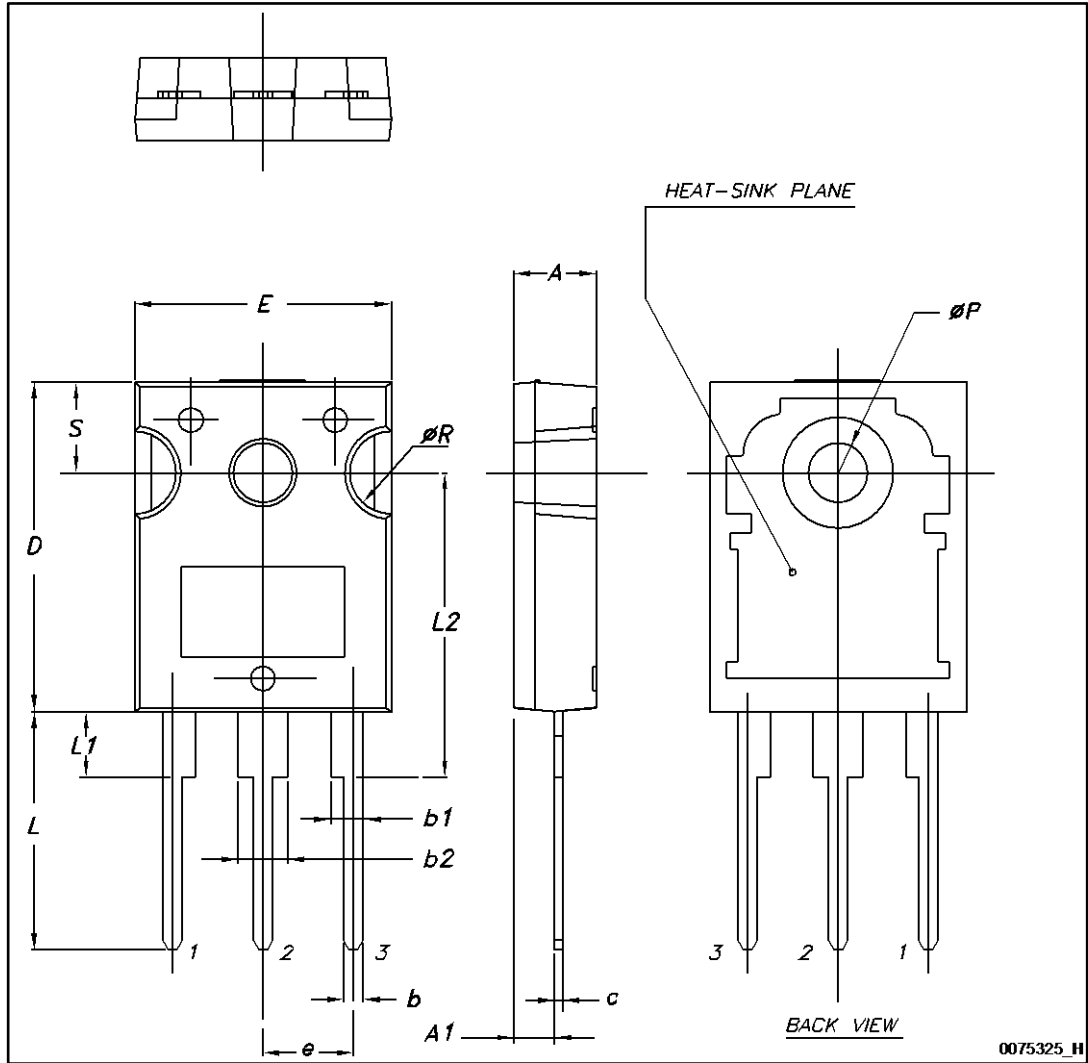
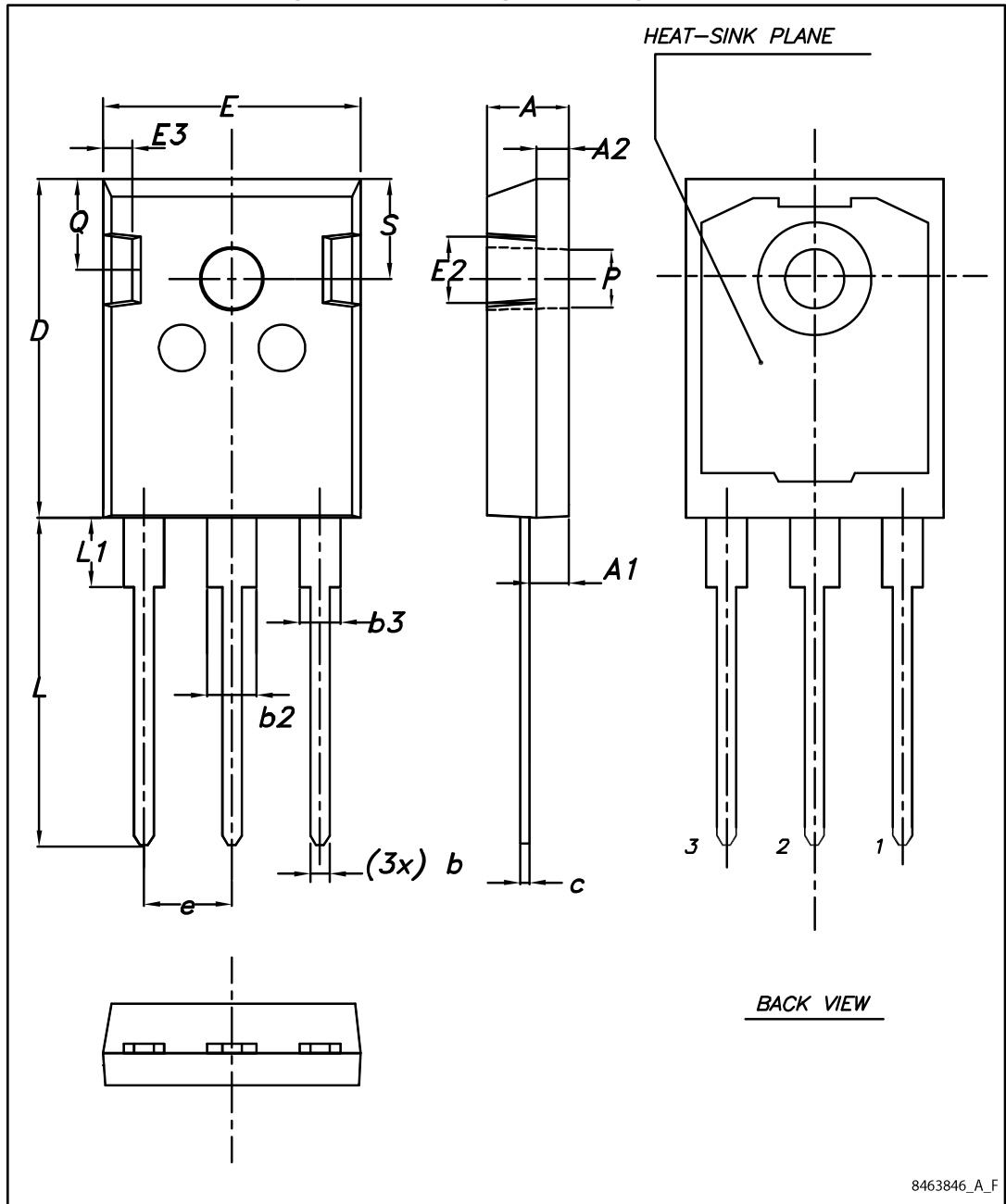

Table 8: TO-247 package mechanical data

| Dim. | mm | | |
|------|-------|-------|-------|
| | Min. | Typ. | Max. |
| A | 4.85 | | 5.15 |
| A1 | 2.20 | | 2.60 |
| b | 1.0 | | 1.40 |
| b1 | 2.0 | | 2.40 |
| b2 | 3.0 | | 3.40 |
| c | 0.40 | | 0.80 |
| D | 19.85 | | 20.15 |
| E | 15.45 | | 15.75 |
| e | 5.30 | 5.45 | 5.60 |
| L | 14.20 | | 14.80 |
| L1 | 3.70 | | 4.30 |
| L2 | | 18.50 | |
| ØP | 3.55 | | 3.65 |
| ØR | 4.50 | | 5.50 |
| S | 5.30 | 5.50 | 5.70 |

4.2 TO-247 long leads package information

Figure 34: TO-247 long lead package outline



8463846_A_F

Table 9: TO-247 long lead package mechanical data

| Dim. | mm | | |
|------|-------|-------|-------|
| | Min. | Typ. | Max. |
| A | 4.90 | 5.00 | 5.10 |
| A1 | 2.31 | 2.41 | 2.51 |
| A2 | 1.90 | 2.00 | 2.10 |
| b | 1.16 | | 1.26 |
| b2 | | | 3.25 |
| b3 | | | 2.25 |
| c | 0.59 | | 0.66 |
| D | 20.90 | 21.00 | 21.10 |
| E | 15.70 | 15.80 | 15.90 |
| E2 | 4.90 | 5.00 | 5.10 |
| E3 | 2.40 | 2.50 | 2.60 |
| e | 5.34 | 5.44 | 5.54 |
| L | 19.80 | 19.92 | 20.10 |
| L1 | | | 4.30 |
| P | 3.50 | 3.60 | 3.70 |
| Q | 5.60 | | 6.00 |
| S | 6.05 | 6.15 | 6.25 |

5 Revision history

Table 10: Document revision history

| Date | Revision | Changes |
|-------------|----------|---|
| 11-May-2016 | 1 | First release. |
| 19-Sep-2016 | 2 | Datasheet promoted from preliminary to production data. Updated Table 2: "Absolute maximum ratings" . Updated Section 2: "Electrical characteristics" . Added Section 2.1: "Electrical characteristics (curves)" . |

IMPORTANT NOTICE – PLEASE READ CAREFULLY

STMicroelectronics NV and its subsidiaries ("ST") reserve the right to make changes, corrections, enhancements, modifications, and improvements to ST products and/or to this document at any time without notice. Purchasers should obtain the latest relevant information on ST products before placing orders. ST products are sold pursuant to ST's terms and conditions of sale in place at the time of order acknowledgement.

Purchasers are solely responsible for the choice, selection, and use of ST products and ST assumes no liability for application assistance or the design of Purchasers' products.

No license, express or implied, to any intellectual property right is granted by ST herein.

Resale of ST products with provisions different from the information set forth herein shall void any warranty granted by ST for such product.

ST and the ST logo are trademarks of ST. All other product or service names are the property of their respective owners.

Information in this document supersedes and replaces information previously supplied in any prior versions of this document.

© 2016 STMicroelectronics – All rights reserved