

7'000 mm

- ✓ M18 short housing
- ✓ IO-Link
- ✓ Sensitivity adjustment via IO-Link
- ✓ Polarizing filter
- ✓ Calibrated range
- ✓ Immunity to mutual interferences

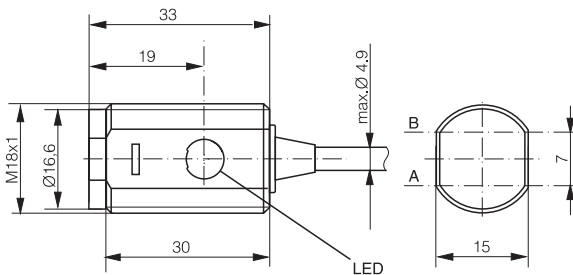

A: emitter axis B: receiver axis

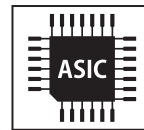
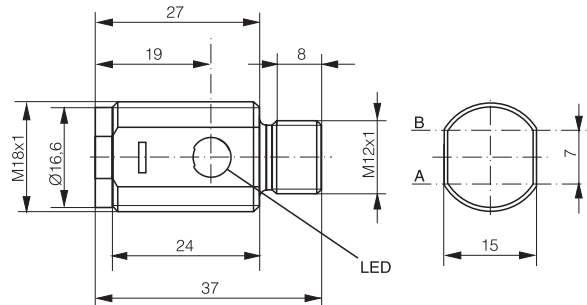

A: emitter axis B: receiver axis

OPTICAL DATA		INTERFACE	
Sensing range typ. max.	20...7'000 mm ¹	Sensitivity adjustment	2'500...7'000 mm, IO-Link
Operating range	30...5'500 mm ¹	Indicator LED, green	Excess gain
Light source	LED, red 630 nm	Indicator LED, yellow	Sensing state
Light spot size (distance)	Ø 21 mm (1 m)/Ø 110 mm (6 m)	IO-Link	✓
Polarizing filter	✓	MTTF (@40°C)	652 y

¹Reference reflector LXR-0000-084

ELECTRICAL DATA		MECHANICAL DATA	
Supply voltage range (U _b)	10...30 VDC	Enclosure rating	IP67
Residual ripple	≤ 10% V _{pp}	Ambient temperature operation	-25...+65°C
Output current	≤ 200 mA	Shock and vibration	IEC 60947-5-2
Signal PNP high/low	≤ (U _b -2.0 V)/approx. 0 V	Weight (connector version)	6 g
Signal NPN high/low	Approx. U _b /≤ 2.0 V	Weight (cable version)	71 g
Power consumption (no load)	≤ 15 mA	Housing material	ABS
Response time ¹	≤ 340 μs (normal)/≤ 1 ms/≤ 115 μs	Window material	PMMA
Switching frequency ¹	≤ 1.5 kHz (normal)/≤ 500 Hz/≤ 4.5 kHz	Connection cable	PVC, 2 m, 3-wire or 4-wire
Short circuit protection	✓	Connector type	M12 4-pin
Voltage reversal protection	✓	Max tightening torque	1 Nm

¹By default, "Normal" mode. "Fine" and "Fast" modes selectable via IO-Link.

SENSING RANGE **EXCESS GAIN**

Target	Operating range	Sensing range typ. max.
LXR-0000-084	30...5'500 mm	20...7'000 mm
LXR-0000-046	30...4'000 mm ¹	20...4'900 mm ¹
LXR-0001-088	30...7'300 mm ¹	20...9'200 mm ¹
LXR-0001-064	30...5'200 mm ¹	20...6'500 mm ¹

¹Indicative value

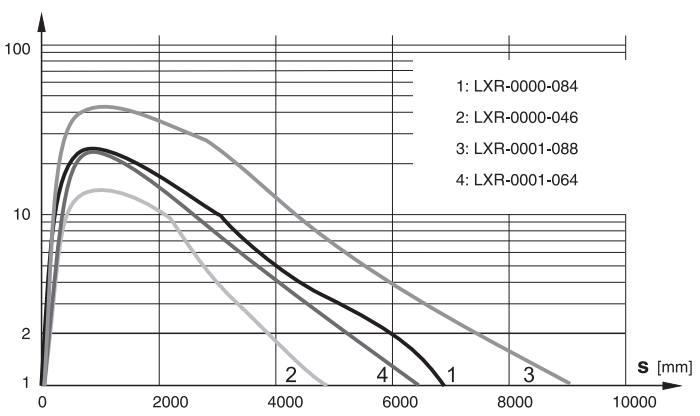

IO-LINK FUNCTIONALITIES **STABILITY ALARM OUTPUT (A2)**

IO-Link version	1.0
SIO mode	Supported
Process data	Detection state & stability alarm
Baudrate	COM2 (38.4 kBaud)
Special functions	Output configuration, output timing, sensitivity, sensor mode, detection counter, event flags, maximum and actual sensor temperature

IO-Link specifications and IODD files may be downloaded from www.contrinex.com (Download section)

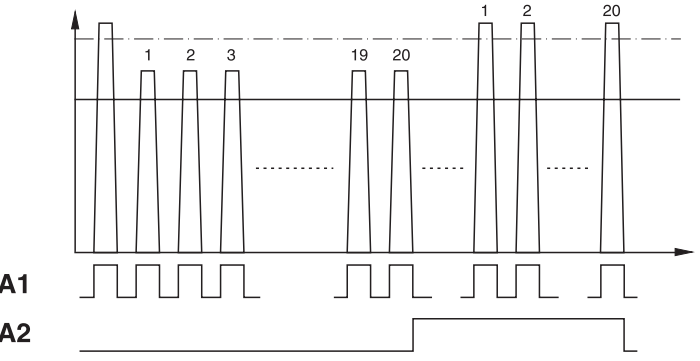

WIRING DIAGRAM **PIN ASSIGNMENT**

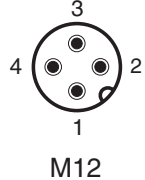
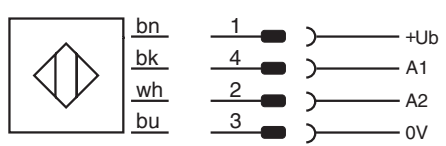
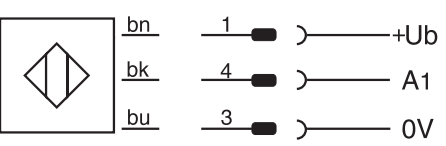

AVAILABLE TYPES

Part number	Part reference	Polarity	Connection	Output (A1)	Output (A2)
620 600 182	LRR-M18PA-NMK-404	PNP	PVC, 2 m, 3-wire	Dark-on/IO-Link	-
620 600 183	LRR-M18PA-NMK-603	PNP	PVC, 2 m, 4-wire	Light-on/IO-Link	Dark-on
620 600 184	LRR-M18PA-NMK-60D	PNP	PVC, 2 m, 4-wire	Dark-on/IO-Link	Stability alarm
620 600 185	LRR-M18PA-NMK-302	NPN	PVC, 2 m, 3-wire	Dark-on	-
620 600 186	LRR-M18PA-NMK-101	NPN	PVC, 2 m, 4-wire	Light-on	Dark-on
620 600 187	LRR-M18PA-NMK-10B	NPN	PVC, 2 m, 4-wire	Dark-on	Stability alarm
620 600 188	LRR-M18PA-NMS-404	PNP	Connector M12 4-pin	Dark-on/IO-Link	-
620 600 189	LRR-M18PA-NMS-603	PNP	Connector M12 4-pin	Light-on/IO-Link	Dark-on
620 600 190	LRR-M18PA-NMS-60D	PNP	Connector M12 4-pin	Dark-on/IO-Link	Stability alarm
620 600 191	LRR-M18PA-NMS-302	NPN	Connector M12 4-pin	Dark-on	-
620 600 192	LRR-M18PA-NMS-101	NPN	Connector M12 4-pin	Light-on	Dark-on
620 600 193	LRR-M18PA-NMS-10B	NPN	Connector M12 4-pin	Dark-on	Stability alarm

Note: additional suffix can appear to indicate a revision version or a special version.

Operators of the products we supply are responsible for compliance with measures for the protection of persons. The use of our equipment in applications where the safety of persons might be at risk is only authorized if the operator observes and implements separate, appropriate and necessary measures for the protection of persons and machines. Terms of delivery and rights to change design reserved.

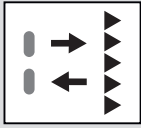

7'000 mm

- ✓ Boîtier court M18
- ✓ IO-Link
- ✓ Réglage de la sensibilité via IO-Link
- ✓ Filtre polariseur
- ✓ Domaine calibré
- ✓ Immunité aux interférences mutuelles

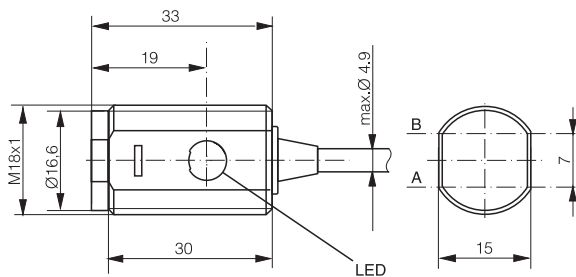
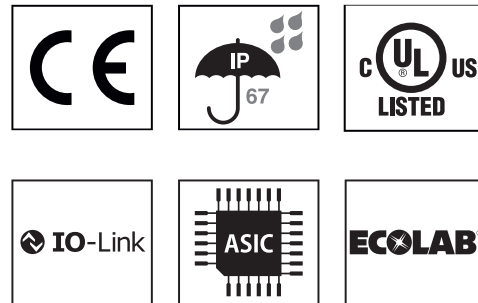

A: axe de l'émetteur B: axe du récepteur

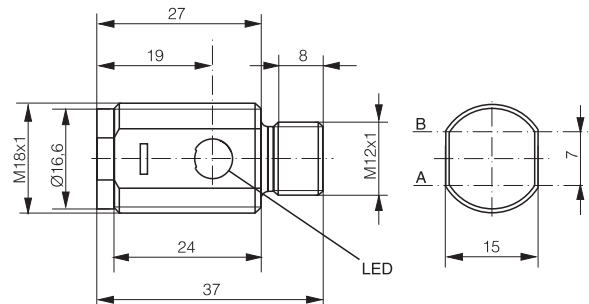

A: axe de l'émetteur B: axe du récepteur

DONNÉES OPTIQUES		INTERFACE	
Domaine de détection typ. max.	20...7'000 mm ¹	Réglage sensibilité	2'500...7'000 mm, IO-Link
Domaine de fonctionnement	30...5'500 mm ¹	Indicateur LED, vert	Réserve de fonctionnement
Source lumineuse	LED, rouge 630 nm	Indicateur LED, jaune	Etat de détection
Taille tache lumineuse (distance)	Ø 21 mm (1 m)/Ø 110 mm (6 m)	IO-Link	✓
Filtre polarisateur	✓	MTTF (@40°C)	652 y

¹Réflecteur de référence LXR-0000-084

DONNÉES ÉLECTRIQUES		DONNÉES MÉCANIQUES	
Tension d'alimentation (U _b)	10...30 VDC	Indice de protection	IP67
Ondulation résiduelle	≤ 10 Vpp	Temp. ambiante d'utilisation	-25...+65°C
Courant de sortie	≤ 200 mA	Chocs et vibrations	IEC 60947-5-2
Tension de sortie haut/bas (PNP)	≤ (U _b -2.0 V)/ approx. 0 V	Poids (version connecteur)	6 g
Tension de sortie haut/bas (NPN)	Approx. U _b / ≤ 2.0 V	Poids (version câble)	71 g
Consommation (hors charge)	≤ 15 mA	Matériau du boîtier	ABS
Temps de réponse	≤ 340 µs (normal)/≤ 1 ms/≤ 115 µs	Matériau de la fenêtre	PMMA
Fréquence de commutation	≤ 1.5 kHz (normal)/≤ 500 Hz/≤ 4.5 kHz	Câble de raccordement	PVC, 2 m, 3 fils ou 4 fils
Protection contre les courts-circuits	✓	Type de connecteur	M12 4 pins
Protection contre les inversions	✓	Couple de serrage max.	1 Nm

¹Par défaut, mode "Normal". Modes "Fine" et "Fast" sélectionnables via IO-Link.

DOMAINE DE DÉTECTION

RÉSERVE DE FONCTIONNEMENT

Cible	Domaine de fonctionnement	Domaine de détection typ. max.
LXR-0000-084	30...5'500 mm	20...7'000 mm
LXR-0000-046	30...4'000 mm ¹	20...4'900 mm ¹
LXR-0001-088	30...7'300 mm ¹	20...9'200 mm ¹
LXR-0001-064	30...5'200 mm ¹	20...6'500 mm ¹

¹Valeur indicative

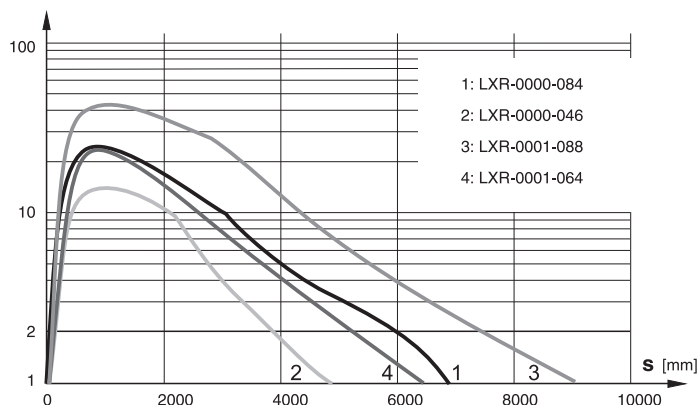

FONCTIONNALITÉS IO-LINK

SORTIE ALARME DE STABILITÉ (A2)

Version IO-Link	1.0
Mode SIO	Disponible
Process data	Etat de détection et alarme stabilité
Baudrate	COM2 (38.4 kBaud)
Fonctions spéciales	Configuration sortie, temporisation sortie, sensibilité, mode du capteur, compteur de détections, flags d'erreur, température max. et actuelle du capteur

Les spécifications IO-Link et les fichiers IODD peuvent être téléchargés depuis www.contrinex.com (onglet Télécharger)



SCHÉMA DE RACCORDEMENT

ATTRIBUTION DES PINS

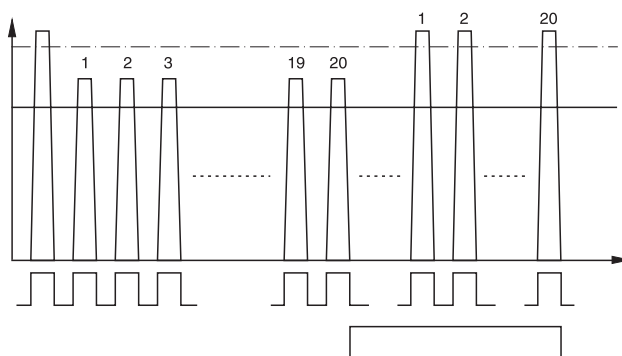
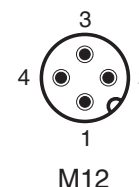
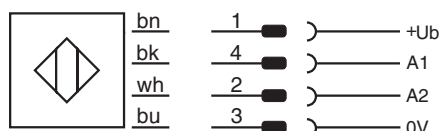
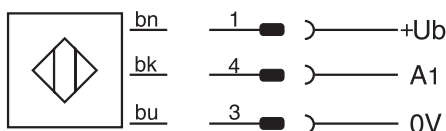

TYPES DISPONIBLES

Numéro d'article	Désignation	Polarité	Raccordement	Sortie (A1)	Sortie (A2)
620 600 182	LRR-M18PA-NMK-404	PNP	PVC, 2 m, 3 fils	Sans réception/IO-Link	-
620 600 183	LRR-M18PA-NMK-603	PNP	PVC, 2 m, 4 fils	En réception/IO-Link	Sans réception
620 600 184	LRR-M18PA-NMK-60D	PNP	PVC, 2 m, 4 fils	Sans réception/IO-Link	Alarme de stabilité
620 600 185	LRR-M18PA-NMK-302	NPN	PVC, 2 m, 3 fils	Sans réception	-
620 600 186	LRR-M18PA-NMK-101	NPN	PVC, 2 m, 4 fils	En réception	Sans réception
620 600 187	LRR-M18PA-NMK-10B	NPN	PVC, 2 m, 4 fils	Sans réception	Alarme de stabilité
620 600 188	LRR-M18PA-NMS-404	PNP	Connecteur M12 4 pins	Sans réception/IO-Link	-
620 600 189	LRR-M18PA-NMS-603	PNP	Connecteur M12 4 pins	En réception/IO-Link	Sans réception
620 600 190	LRR-M18PA-NMS-60D	PNP	Connecteur M12 4 pins	Sans réception/IO-Link	Alarme de stabilité
620 600 191	LRR-M18PA-NMS-302	NPN	Connecteur M12 4 pins	Sans réception	-
620 600 192	LRR-M18PA-NMS-101	NPN	Connecteur M12 4 pins	En réception	Sans réception
620 600 193	LRR-M18PA-NMS-10B	NPN	Connecteur M12 4 pins	Sans réception	Alarme de stabilité

Remarque: la présence d'un suffixe supplémentaire indique une version révisée ou une version spéciale.

Les exploitants des produits que nous fournissons sont tenus d'assurer des mesures adéquates de protection des personnes. L'utilisation de nos appareils dans des applications comportant un risque possible pour la sécurité des personnes n'est admissible que si l'exploitant observe et met en œuvre des mesures séparées, appropriées et nécessaires pour la protection des personnes et des machines. Sous réserve de modifications et de possibilités de livraison.

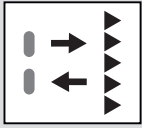

7'000 mm

- ✓ Kurzes M18 Gehäuse
- ✓ IO-Link
- ✓ Empfindlichkeitseinstellung via IO-Link
- ✓ Polfilter
- ✓ Kalibrierter Bereich
- ✓ Immunität zu gegenseitigen Beeinflussungen

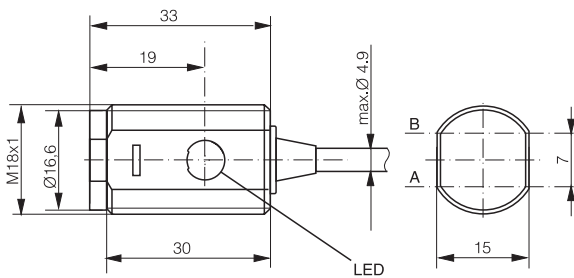
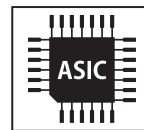

A: Senderachse B: Empfängerachse

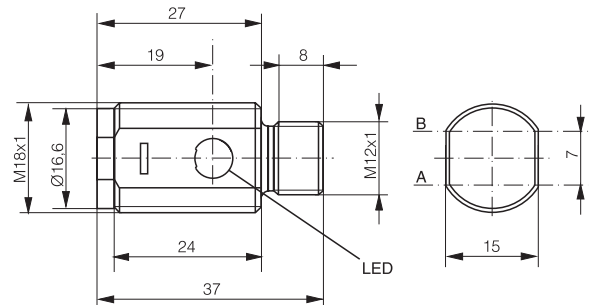

A: Senderachse B: Empfängerachse

OPTISCHE DATEN		INTERFACE	
Erfassungsbereich typ. max.	20...7'000 mm ¹	Empfindlichkeitseinstellung	2'500...7'000 mm, IO-Link
Arbeitsbereich	30...5'500 mm ¹	Anzeige-LED, grün	Funktionsreserve
Lichtquelle	LED, rot 630 nm	Anzeige-LED, gelb	Erfassungsstatus
Lichtfleckgrösse (Entfernung)	Ø 21 mm (1 m)/Ø 110 mm (6 m)	IO-Link	✓
Polfilter	✓	MTTF (@40°C)	652 y

¹Referenzreflektor LXR-0000-084

ELEKTRISCHE DATEN		MECHANISCHE DATEN	
Versorgungsspannung (U _b)	10...30 VDC	Schutzart	IP67
Restwelligkeit	≤ 10 Vpp	Umgebungstemperatur Betrieb	-25...+65°C
Ausgangsstrom	≤ 200 mA	Schocks und Vibrationen	IEC 60947-5-2
Ausgangsspannung high/low (PNP)	≤ (U _b -2.0 V)/ ca. 0 V	Gewicht (Steckerversion)	6 g
Ausgangsspannung high/low (NPN)	ca. U _b / ≤ 2.0 V	Gewicht (Kabelversion)	71 g
Stromaufnahme (ohne Last)	≤ 15 mA	Gehäusematerial	ABS
Ansprechzeit	≤ 340 µs (normal)/≤ 1 ms/≤ 115 µs	Fenstermaterial	PMMA
Schaltfrequenz	≤ 1.5 kHz (normal)/≤ 500 Hz/≤ 4.5 kHz	Anschlusskabel	PVC, 2 m, 3- oder 4-adrig
Kurzschlusschutz	✓	Anschlussstecker	M12 4-Pin
Verpolungsschutz	✓	Max. Anzugsdrehmoment	1 Nm

¹Standardmässig im "Normal"-Modus. "Fine"- und "Fast"-Modus wählbar über IO-Link.

ERFASSUNGSBEREICH

FUNKTIONSRESERVE

Zielobjekt	Arbeitsbereich	Erfassungsbereich typ. max.
LXR-0000-084	30...5'500 mm	20...7'000 mm
LXR-0000-046	30...4'000 mm ¹	20...4'900 mm ¹
LXR-0001-088	30...7'300 mm ¹	20...9'200 mm ¹
LXR-0001-064	30...5'200 mm ¹	20...6'500 mm ¹

¹Richtwert

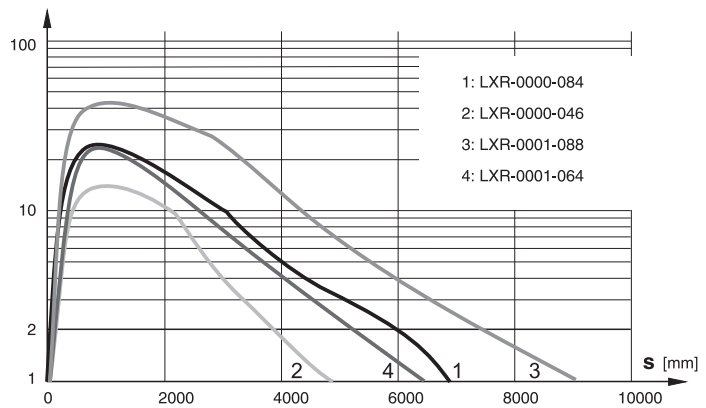

IO-LINK-FUNKTIONALITÄTEN

AUSGANG STABILITÄTSALARM (A2)

IO-Link-Version	1.0
SIO-Modus	Unterstützt
Prozessdaten	Erfassungsstatus u. Stabilitätsalarm
Baudrate	COM2 (38.4 kBaud)
Sonderfunktionen	Ausgang Konfiguration, Schaltverzögerung, Empfindlichkeit, Sensormodus, Erfassungscounter, Event-Flags, maximale u. aktuelle Sensortemperatur

IO-Link-Spezifikationen und IODD-Dateien werden von www.contrinex.com heruntergeladen (Register Download)

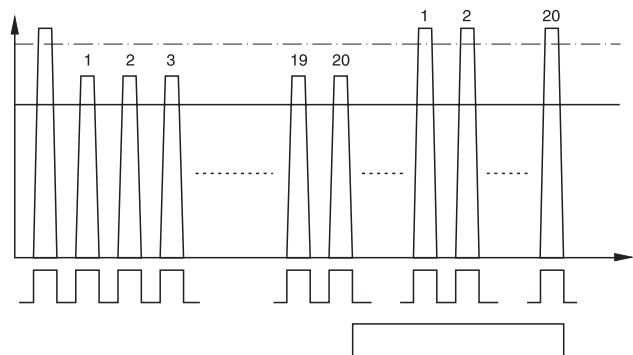

ANSCHLUSSSCHEMA

STECKERBELEGUNG

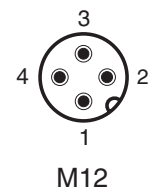
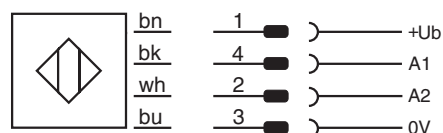
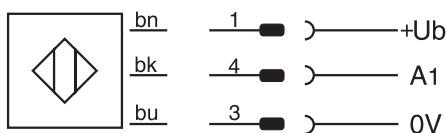

VERFÜGBARE TYPEN

Artikelnummer	Bezeichnung	Schaltung	Anschluss	Ausgang (A1)	Ausgang (A2)
620 600 182	LRR-M18PA-NMK-404	PNP	PVC, 2 m, 3-adrig	Dunkelschalt./IO-Link	-
620 600 183	LRR-M18PA-NMK-603	PNP	PVC, 2 m, 4-adrig	Hellschaltend/IO-Link	Dunkelschaltend
620 600 184	LRR-M18PA-NMK-60D	PNP	PVC, 2 m, 4-adrig	Dunkelschalt./IO-Link	Stabilitätsalarm
620 600 185	LRR-M18PA-NMK-302	NPN	PVC, 2 m, 3-adrig	Dunkelschaltend	-
620 600 186	LRR-M18PA-NMK-101	NPN	PVC, 2 m, 4-adrig	Hellschaltend	Dunkelschaltend
620 600 187	LRR-M18PA-NMK-10B	NPN	PVC, 2 m, 4-adrig	Dunkelschaltend	Stabilitätsalarm
620 600 188	LRR-M18PA-NMS-404	PNP	Stecker M12 4-Pin	Dunkelschalt./IO-Link	-
620 600 189	LRR-M18PA-NMS-603	PNP	Stecker M12 4-Pin	Hellschaltend/IO-Link	Dunkelschaltend
620 600 190	LRR-M18PA-NMS-60D	PNP	Stecker M12 4-Pin	Dunkelschalt./IO-Link	Stabilitätsalarm
620 600 191	LRR-M18PA-NMS-302	NPN	Stecker M12 4-Pin	Dunkelschaltend	-
620 600 192	LRR-M18PA-NMS-101	NPN	Stecker M12 4-Pin	Hellschaltend	Dunkelschaltend
620 600 193	LRR-M18PA-NMS-10B	NPN	Stecker M12 4-Pin	Dunkelschaltend	Stabilitätsalarm

Hinweis: Im Fall einer überarbeiteten Version oder Sonderausführung kann die Bezeichnung auch durch eine Endung ergänzt werden.

Die Einhaltung der Personenschutzmaßnahmen obliegt dem Betreiber der von uns gelieferten Produkte. Der Einsatz unserer Geräte in Anwendungen, bei welchen die Sicherheit von Personen gefährdet sein könnte, ist nur dann zulässig, wenn der Betreiber gesonderte geeignete und notwendige Maßnahmen für die Personen- und Maschinensicherheit einhält und vornimmt. Änderungen und Liefermöglichkeiten vorbehalten.