

MST 1-PHASE CONTROL AND ISOLATION TRANSFORMER

P: 1600VA IN: 208...550VAC OUT: 2x115VAC

Single-phase - Control and Isolation Transformers
1600 VA
Isolation class T 40/B

Other voltages on request.

[Link to Product](#)

Illustration

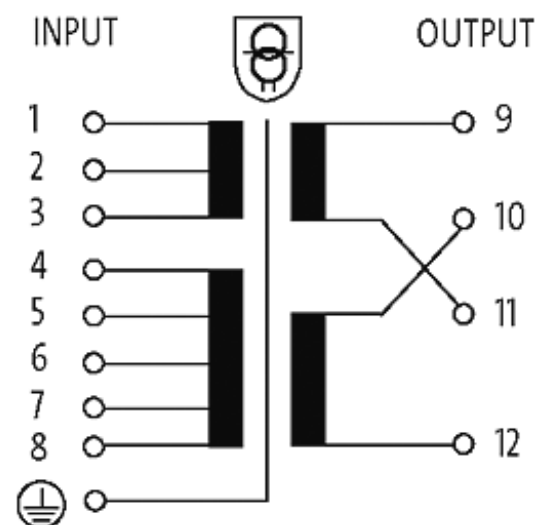

stay connected

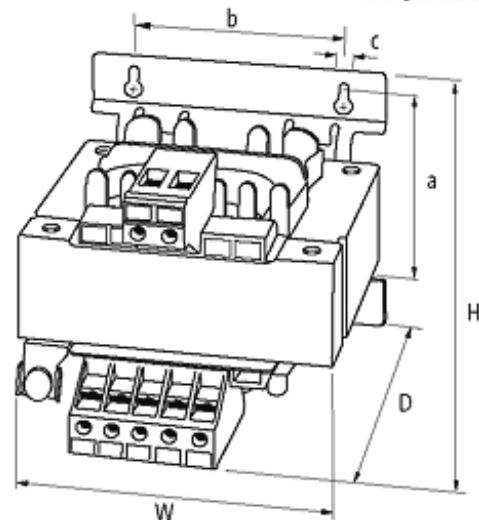

Product may differ from Image

Approvals



Input

Input voltage	208, 230, 380, 400, 420, 440, 460, 480, 500, 525, 550 V AC
Input current	8.8 A (208 V AC); 3.3 A (550 V AC)
Inrush current	182 A (208 V AC); 70 A (550 V AC)
Short-circuit current	460 A (208 V AC); 175 A (550 V AC)
Frequency	50...60 Hz

General data

Standards	(EN 61558-1), (EN 61558-2-4), (EN 62041 category 0)
Test isolation voltage	4 kV (prim./sec.)
Mounting method	Key-hole mounting
Dimensions H × W × D	168×174×163 mm
Fixing centers a × b × c	141×135×7 mm
Drill hole Ø	7×11 mm
Temperature range	-20...+40 °C, no condensation

Output

Output voltage	2 × 115 V AC/230 V AC
----------------	-----------------------

Commercial data

country of origin	CZ
customs tariff number	85043200
minimum order quantity	1