



CIRCUIT BREAKER 3VA2 IEC FRAME 100 BREAKING CAPACITY CLASS C ICU=110KA @ 415 V 4POLE, LINE PROTECTION ETU860, LSIG, IN=40A OVERLOAD PROTECTION IR=16A ...40A SHORT CIRCUIT PROTECTION ISD=0,6..10X IN, II=1,5..12X IN NEUTRAL PROTECTION ADJUSTABLE (OFF, UPTO 160%) GROUNDFAULT, SWITCHABLE IG=0,2... 1 X IN, TG=0,050,8MS CABLE CONNECTION

Model		
product brand name		SENTRON
Product designation		Molded case circuit breaker
Design of the product		Line protection
Product variations		Selective Applications
Ground fault monitoring version		Summation current formation L + N conductor
Design of the auxiliary release		without auxiliary release
Design of the auxiliary switch		Without
Design of the operating mechanism		toggle handle
Type of the driving mechanism / motor drive		No
Design of the overcurrent release		ETU860

General technical data		
Number of poles		4
Trip class / of the L-trip / with I ² t characteristic / initial value		0.5
Trip class / of the L-trip / with I ² t characteristic / Full-scale value		25
Electrical endurance (switching cycles) • at AC-1 / at 380/415 V / at 50/60 Hz		12 000
Total disconnection time / for G-tripping / with standard characteristic / initial value	s	0.05
Total disconnection time / for G-tripping / with standard characteristic / Full-scale value	s	0.8
circuit-breaker / Design		3VA
Mechanical service life (switching cycles) / typical		20 000

Voltage		
Insulation voltage / Rated value	V	800
Protection class		
Protection class IP		IP40
Protection class IP / on the front		IP40
Protective function of the overcurrent release		LSIG
Switching capacity		
Switching capacity class of the circuit breaker		C
Dissipation		
Active power loss		
• maximum	W	2.2
Electricity		
Continuous current / Rated value / maximum	A	100
Continuous current / Rated value	A	40
Adjustable response value current / of the instantaneous short-circuit release / initial value	A	1.5
Main circuit		
Operating voltage		
• with AC / at 50/60 Hz / Rated value	V	690
Operating current		
• at 40 °C / Rated value	A	40
• at 50 °C / Rated value	A	40
• at 60 °C / Rated value	A	40
• at 65 °C / Rated value	A	40
• at 70 °C / Rated value	A	40
Auxiliary circuit		
Number of NC contacts / for auxiliary contacts		0
Number of NO contacts / for auxiliary contacts		0
Suitability		
Suitability for use		system protection
Adjustable parameters		
Adjustable response value current		
• for G-tripping / with I2t characteristic / initial value	A	0.4
• for G-tripping / with I2t characteristic / Full-scale value	A	1
• for G-tripping / with standard characteristic / initial value	A	0.4
• for G-tripping / with standard characteristic / Full-scale value	A	1

• of I-trip / Full-scale value	A	12
• of the short-time delayed short-circuit release / initial value	A	0.6
• of the short-time delayed short-circuit release / Full-scale value	A	10
• of S-trip / with standard characteristic / initial value	A	0.6
• of S-trip / with standard characteristic / Full-scale value	A	10
Adjustable delay time		
• for G-tripping / with I2t characteristic / initial value	s	0.05
• for G-tripping / with I2t characteristic / Full-scale value	s	0.8
• of S-trip / with I2t characteristic / initial value	s	0.05
• of S-trip / with I2t characteristic / Full-scale value	s	0.5
• of S-trip / with standard characteristic / initial value	s	0.05
• of S-trip / with standard characteristic / Full-scale value	s	0.5
Adjustable response value current / of the current-dependent overload release / initial value	A	0.4

Product details

Product component		
• Trip indicator		No
• display		Yes
• undervoltage release		No
Product property		
• of the circuit breaker with tripping unit / Tripping characteristic adjustable		Yes
• for neutral conductors / upgradeable/retrofitable / Short-circuit and overload proof		No
Product expansion / optional / motor drive		Yes

Product function

Product function		
• Intrinsic device protection		Yes
• communication function		Yes
• Phase failure detection		No
• other measurement function		Yes

Accessories

Manufacturer article number / of the supplied basic switch		3VA2040-7KQ46-0AA0
--	--	------------------------------------

Short circuit

Operational short-circuit current breaking capacity (Ics)		
• at 240 V / Rated value	kA	150
• at 415 V / Rated value	kA	110
• at 440 V / Rated value	kA	110
• at 500 V / Rated value	kA	85
• at 690 V / Rated value	kA	2
Maximum short-circuit current breaking capacity (Icu)		
• at 240 V / Rated value	kA	150
• at 415 V / Rated value	kA	110
• at 440 V / Rated value	kA	110
• at 500 V / Rated value	kA	85
• at 690 V / Rated value	kA	2
Short-circuit current making capacity (Icm)		
• at 240 V / Rated value	kA	330
• at 415 V / Rated value	kA	242
• at 440 V / Rated value	kA	242
• at 500 V / Rated value	kA	187
• at 690 V / Rated value	kA	3

Connections

Arrangement of electrical connectors / for main current circuit		Front terminal
Type of connectable conductor cross-section		
• of the round conductor terminal / stranded		1 x (6-120 mm ²)
Type of electrical connection / for main current circuit		Box terminal

Mechanical Design

Height	mm	181
Width	mm	140
Depth	mm	107
Mounting type		fixed mounting

Environmental conditions

Ambient temperature		
• during operation / minimum	°C	-25
• during operation / maximum	°C	70
• during storage / minimum	°C	-40
• during storage / maximum	°C	80

Certificates

Equipment marking		
-------------------	--	--

- acc. to DIN EN 61346-2
- acc. to DIN EN 81346-2

Q

Q

General Product Approval	EMC	Declaration of Conformity	Shipping Approval
---------------------------------	------------	----------------------------------	--------------------------



CCC



VDE

[other](#)

EG-Konf.



DNV

Shipping Approval	other
--------------------------	--------------

[other](#)

GL

Further information

Information- and Downloadcenter (Catalogs, Brochures,...)

<http://www.siemens.com/lowvoltage/catalogs>

Industry Mall (Online ordering system)

<https://eb.automation.siemens.com/mall/en/WW/Catalog/Product/3VA20407KQ460AA0>

Service&Support (Manuals, Certificates, Characteristics, FAQs,...)

<http://support.automation.siemens.com/WW/view/en/3VA20407KQ460AA0/all>

Image database (product images, 2D dimension drawings, 3D models, device circuit diagrams, ...)

http://www.automation.siemens.com/bilddb/cax_en.aspx?mlfb=3VA20407KQ460AA0

CAX-Online-Generator

<http://www.siemens.com/cax>

Tender specifications

<http://ausschreibungstexte.siemens.com/tiplv>

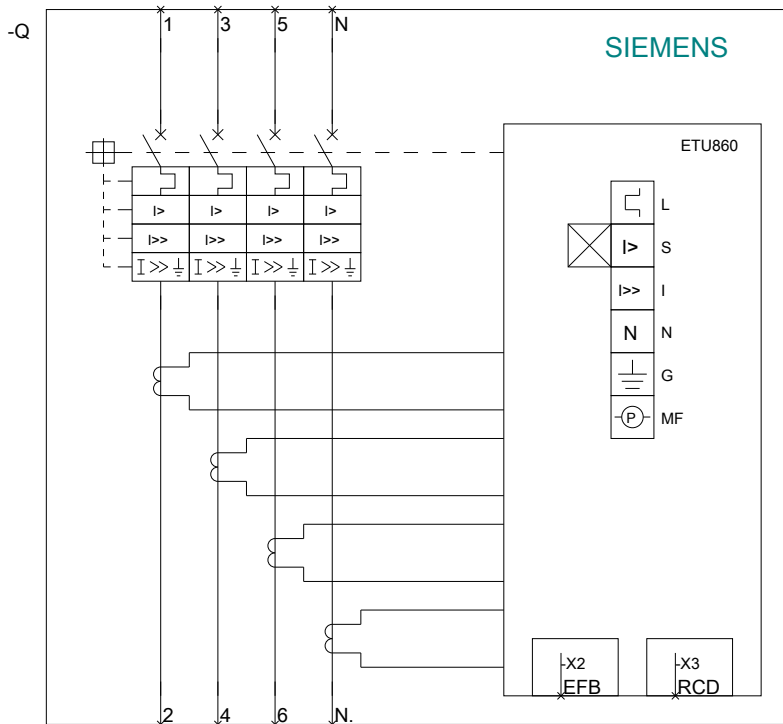
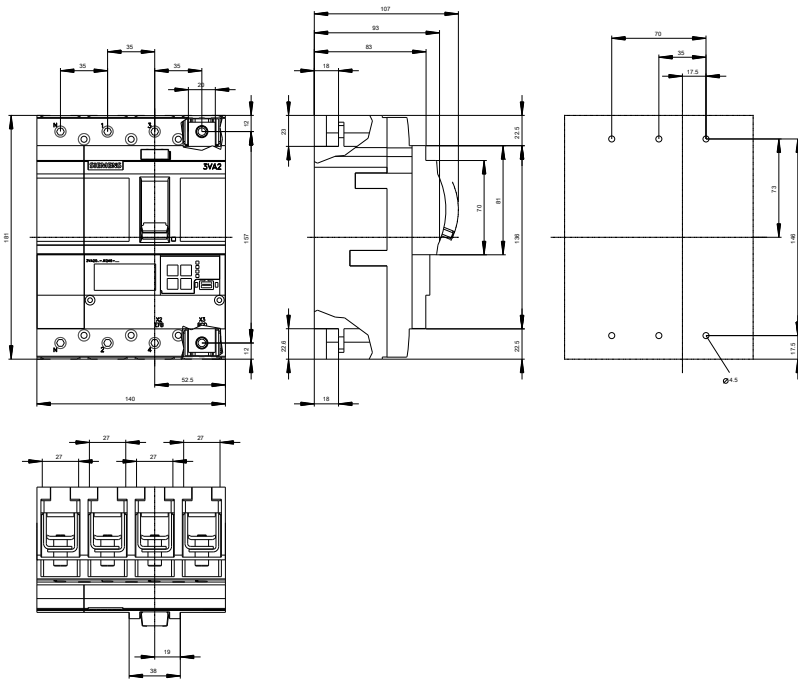

last modified:

11.03.2015