

Machinery Directive 2006/42/EC

Safety control system standard EN ISO 13849-1

Dual residual pressure release valve with position detection sensor

Series VP542-X536 / VP742-X536

Series VP544-X538 / VP744-X538

Series VG342-X87



As leading experts in pneumatics and specialists in factory automation, the development of high quality, innovative products which offer excellent performance has always been at the front of our minds.

This simple premise has helped SMC grow into the global organization it is today, with over 15.300 employees and sales offices in 78 countries around the world.

With the rapid advances in manufacturing and machine technology, safety in engineering is becoming increasingly important and the protection of people working in close proximity to both machines and systems is of paramount importance.

With the introduction of the new Machinery Directive 2006/42/EC, which came into force at the end of June 2006, machine designers in Europe and throughout the world have to consider new requirements and harmonised standards when designing and developing safe machines.



A change in the Standards

The Machinery Directive (MD) 2006/42/EC defines the safety requirements which a machine must meet in order for it to be sold and used in Europe.

EN ISO 13849-1 and EN 62061 are standards which relate specifically to safety system design. From 1st January 2012 these are the only safety system design standards which give the presumption of conformity with the MD. The status of harmonised standards for EU Directives is regularly reviewed and published in the Official Journal of the EU.

An overview

Machinery Directive (MD) 2006/42/EC

Replacing the existing 98/37/EC Machinery Directive, the new MD 2006/42/EC is universally applicable for machinery, safety components, partly completed machinery and other specific equipment.

The manufacturer of machinery has to meet the safety requirements of the MD and confirm this by attaching a CE mark to the machine.



EN ISO 13849-1 and EN 62061

The designer must eliminate risks associated with the machines, its features and operation, before considering measures to reduce or control them (EN ISO12100).

EN ISO 13849-1: provides safety requirements and guidance on the principles for the design and integration of safety-related parts of control systems including the design of software. For safety-related parts of control systems, it specifies characteristics that include the performance level required for carrying out safety functions. It applies to safety-related parts of control systems regardless of the type of technology and energy used (mechanical, pneumatic, hydraulic and electrical), for all kinds of machinery.

EN ISO 62061: specifically addresses the operational safety of safety-related electrical, electronic and programmable electronic control systems.

Safety Standard ISO13849-1

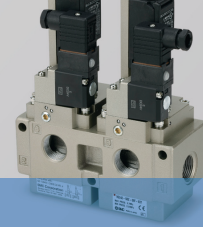

Under EN ISO 13849-1, the consideration of safety starts with the risks associated with the machine, its function and its operation. Machine designers are obliged to eliminate risks before considering further measures to reduce or control risks (EN ISO 12100).

The risks of the machine must be quantified by the machine designer and if the risks are considered high, the designer is obliged to employ systems that reduce the risks to acceptable levels. Once the risks have been reduced to acceptable levels by means of an inherent safe design, then protective devices will be required. At that point, safety functions (SF) must be defined and satisfied by the machine design.

EN ISO13849-1 uses an interactive process for the design of the safety-related parts of control systems, as follows:

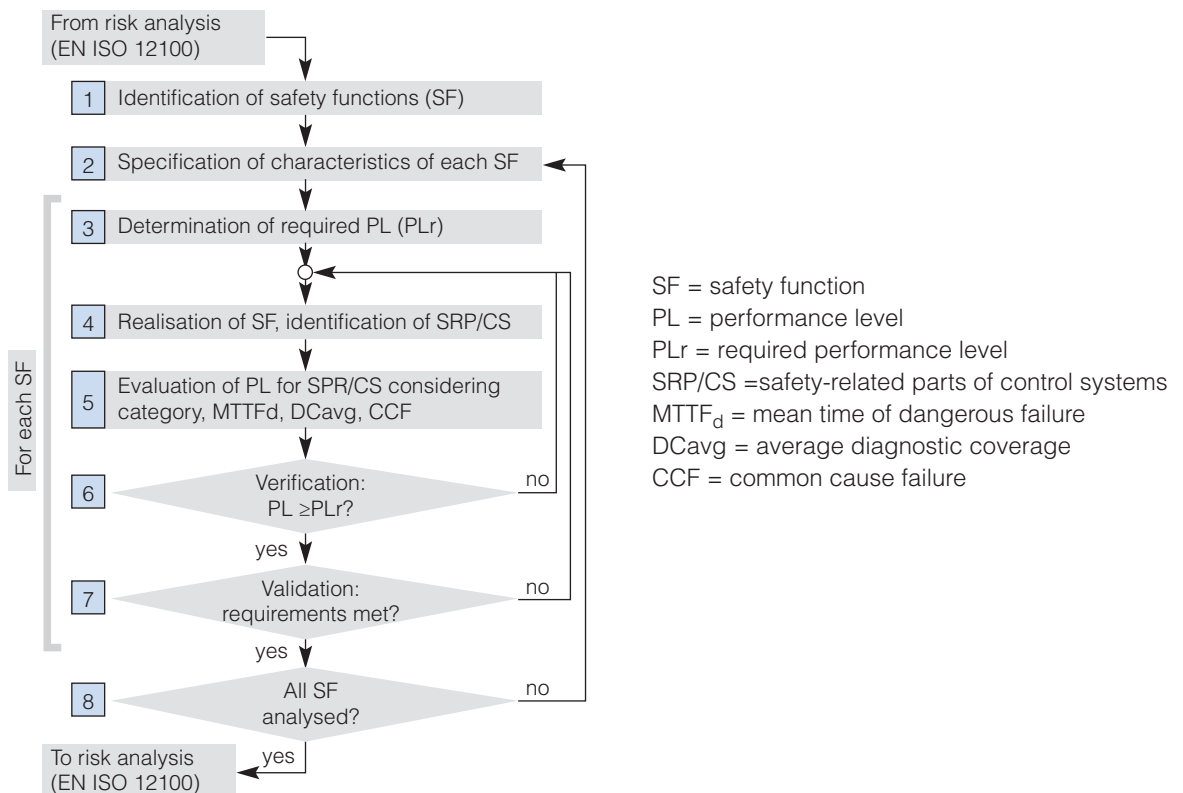

- A required **performance level “PLr”** (target value) must be specified for each intended safety function.
- The safety function requirements are derived from the necessary risk reduction.
- ISO/TR 14121-2 describes methods for determining the necessary level of risk reduction.
- EN ISO 13849-1 employs one of these methods where the following parameters are evaluated:
 - S – Severity of injury
 - F – Frequency and time of exposure to the hazard
 - P – Possibility of avoiding the hazard or limiting the harm.

Following the standard

Determination of Required Performance Level PLr

There are five performance levels: a, b, c, d, e, with “a” being low risk and “e” representing the highest risk.

Each of these five performance levels corresponds to a further parameter scale, based on the probability of a dangerous failure per hour.

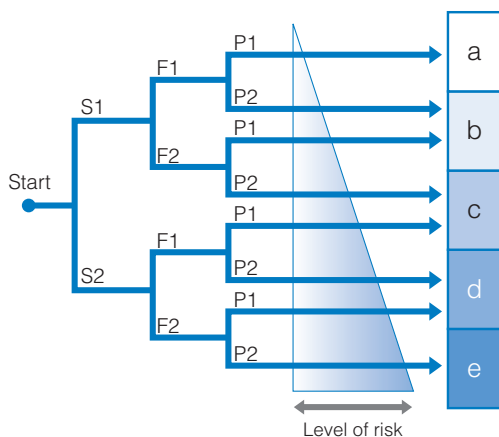

S: Severity of Injury

S1: slight
S2: serious

F: Frequency and/or exposure to the hazard

F1: no often
F2: frequent

P: Possibility of avoiding the hazard or limiting harm

P1: possible
P2: scarcely possible

PL defined statistically

PL	Average probability of dangerous failures per hour, h ⁻¹
a	$\geq 10^{-5}$ to $< 10^{-4}$
b	$\geq 3 \times 10^{-6}$ to $< 10^{-5}$
c	$\geq 10^{-6}$ to $< 3 \times 10^{-6}$
d	$\geq 10^{-7}$ to $< 10^{-6}$
e	$\geq 10^{-8}$ to $< 10^{-7}$

Once the safety function (SF) and the required risk reduction PLr have been defined, the actual design of the SRP/CS can begin - as suitable protective measures have to be used to match the performance levels.

Determination of Performance Level PL

The following elements define the performance level or PL:

1. The **architecture** categories of the safety system
2. The reliability of the safety system (**MTTF_d**)
3. How easily faults can be detected (**DCavg**)
4. How vulnerable the system is to failure (**CCF**)

Once the design of the safety control systems has been completed and the PLs have been determined, a verification and validation process should be completed in accordance with EN ISO13849-2.

Architecture categories of the safety system

The architecture categories help to classify the safety-related parts of a control system (SRP/CS) in relation to their resistance to faults and their subsequent behaviour in the fault condition, based upon the reliability and/or the structural arrangement of the parts.

For defining the probability of failure and the PL, the architecture categories provide the major definition, completed by the component reliability (MTTF_d), the diagnostic coverage (DCavg), and the resistance to common cause failures (CCF) information.

There are five architecture categories: B, 1, 2, 3, 4.

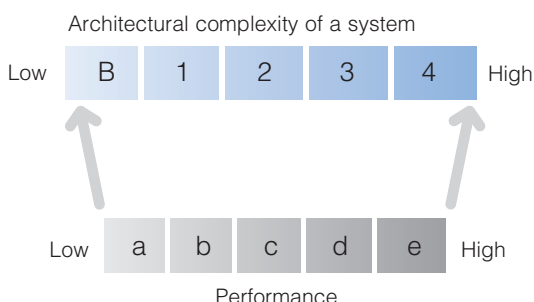

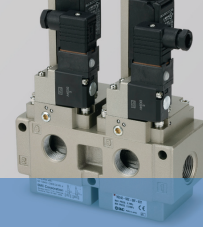

Architecture categories – B and 1

In categories B and 1, the resistance to faults is achieved primarily by the selection and use of suitable components. Category 1 has a greater resistance than category B because of the use of basic and well-tried principles, as well as well-tried components, which are tested in a safety context.

A typical application:

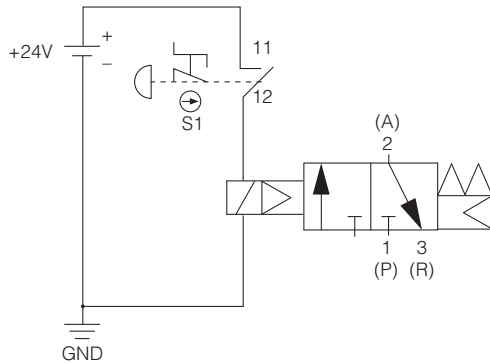

The simple system to remove supply pressure possibly suitable for low risk application which is PL 'a'

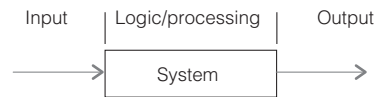

Architecture – category 2

Category 2 combines all of the requirements of architecture B with well-tried safety principles. Additionally the system is checked for faults affecting the safety function.

These checks are made at regular intervals, e.g. at start-up, or before the next demand on the safety function. By using an appropriate selection of test intervals, a suitable risk reduction can be attained.

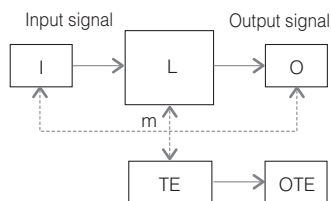

Architecture categories – 3 and 4

In categories 3 and 4, the occurrence of a single fault does not result in the loss of the safety function. In category 4, and whenever reasonably practical in category 3, such faults are detected automatically. In category 4, accumulation of faults will not lead to a loss of the safety function.

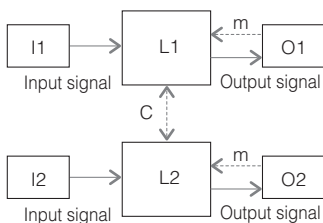

m: monitoring of output state
c: cross monitoring of logic channels

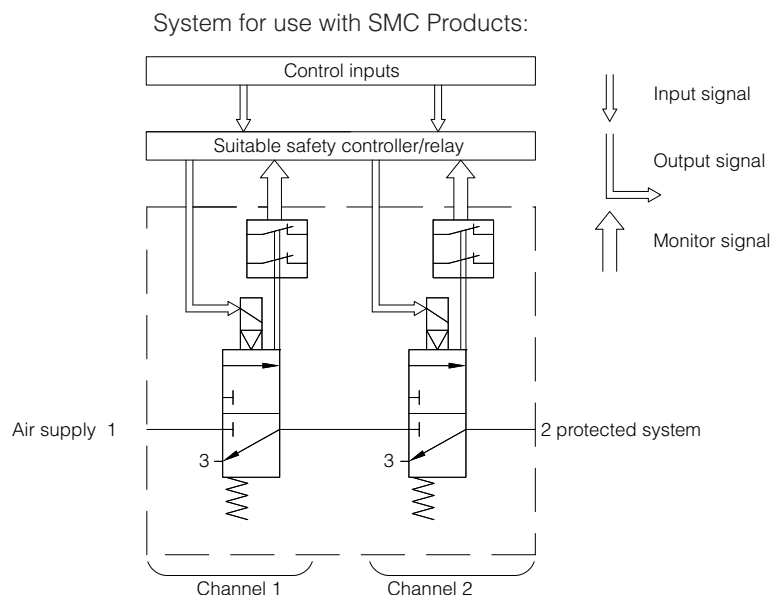

SMC special product - in this example the product being tested is our series VG342(R)-□-X87.

Reliability of a safety system

The reliability of a system has to be quantified as part of the Performance level (PL).

Reliability is expressed as the Mean Time to Dangerous Failure (MTTF_d) which is measured in hours. The MTTF_d should be determined from the component manufacturer's data.

However, as this is application-specific, the components MTTF_d cannot be quoted in isolation as the manufacturer is not aware of the exact machine application.

As the world leading experts in pneumatics we will provide estimated MTTF or B₁₀ values, to help support our customers. However, we (SMC) will not accept liability for the use of these components in safety systems beyond our normal warranty terms.

MTTF or B₁₀ are defined respectively as mean time to failure or number of cycles until 10% of the components has exceeded fixed limits under defined conditions, such as response time, leakage, or switching pressure.

Finding the MTTF_d - Value of a pneumatic component with B₁₀ - Value according to EN ISO 13849-1

Input parameter:

- B₁₀: Number of cycles, until 10% of the components fails
- h_{OP}: Mean operation [hours/day]
- TCycle: Mean time between the beginning of two successive cycles of the component [s/cycle]

Output parameter:

- n_{OP}: Mean number of annual operations
- B_{10d}: Number of cycles, until 10% of the components fails dangerously
- MTTF_d: Mean time to dangerous failure

Typical procedure (in certain circumstances):

$$B_{10d} = 2 \times B_{10}$$

$$n_{OP} = \frac{d_{OP} \times h_{OP} \times 3600[s/h]}{TCycle}$$

$$MTTF_d = \frac{B_{10d}}{0.1 \times n_{OP}}$$

Finding the MTTF_d - Value of a component which combines both electronic and pneumatic parts

The dependency of the probability of failure related to time (electronic) as well as cycles (pneumatic component) is an indication of such a combined system (combined fluid and electric systems).

The total MTTF_d - value of the combined system will be determined from the B_{10d} value of the pneumatic component and the MTTF_d - value of the electronic components.

In case of a valve, the tested B₁₀ valve represents the mechanical and the electrical part of the valve.

Diagnostic Coverage

A factor called **DC (Diagnostic Coverage)** is a measure of how effectively failures can be detected by monitoring systems.

Sensors can be used to detect faults when monitored by a logic / processing device.

EN ISO 13849-1 provides the means of estimating **DC** which is then used as part of the determination of **PL**.

Diagnostic Coverage is defined as the measure of the effectiveness of diagnostics, which may be determined as the ratio between the failure rate of detected dangerous failures and the failure rate of total dangerous failures; so 0% ~ no dangerous faults are detected and approaching 100% ~ most faults detected (but =100% is impossible because diagnostics are not considered to be completely reliable).

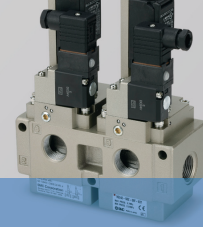

Diagnostic coverage categories:

Category	Range
None	DC < 60%
Low	60% ≤ DC < 90%
Medium	90% ≤ DC < 99%
High	99% ≤ DC

Diagnostic coverage estimates (for output devices such as SMC valves with position detection):

Measure	Diagnostic coverage
Monitoring of outputs by one channel without dynamic test.	0% to 99% depending on how often a signal change is done by the application.
Cross monitoring of outputs without dynamic test.	0% to 99% depending on how often a signal change is done by the application.
Cross monitoring of output signals with dynamic test without detection of short circuits (for multiple I/O)	90%
Cross monitoring of output signals and intermediate results within the logic and temporal and logical software monitor of the program flow and detection of static faults and short circuits (for multiple I/O)	99%
Redundant shut-off path with no monitoring of the actuator	0%
Redundant shut-off with monitoring of one of the actuators either by logic or by test equipment	90%
Redundant shut-off path with monitoring of the actuators by logic and test equipment	99%
Indirect monitoring (e.g. monitoring by pressure switch, electrical position monitoring of actuators)	90% to 99%, depending on the application
Fault detection by the process	0% to 99%, depending on the application; this measure alone is not sufficient for the required performance level 'e'
Direct monitoring (e.g. electrical position monitoring of control valves, monitoring of electromechanical devices by mechanically linked contact elements)	99%

Common Cause Failure

It is necessary to consider how single failures might affect safety systems when there is redundancy in the system. Redundancy can be compromised if both channels fail simultaneously due to the same cause. This factor is called **CCF (Common Cause Failure)**.

EN ISO 13849-1 provides a score for **CCF**, which is used to determine the Performance level **PL**.

For this score, EN ISO13849-1 defines a checklist of eight important countermeasures, which are evaluated as follows:

- Physical separation between the signal paths of different channels (15 points)
- Diversity in the technology, the design or the physical principles of the channels (20 points)
- Protection against possible overloading (15 points) and the use of well-tried components (5 points)
- Failure mode and effects analysis during development for the identification of potential common cause failures (5 points)
- Training of designer/maintainers in CCF and its avoidance (5 points)
- Protection against common cause failures triggered by contamination (mechanical and fluidic system) and electromagnetic interference (electrical system) (25 points)
- Protection about common cause failures triggered by unfavourable environmental conditions (10 points)

A maximum score of 100 points can be obtained, but even for categories 2, 3 and 4, EN ISO13849-1 requires only a minimum total of 65 points.

Note: CCF is always system-dependent and application-specific.

After these four essential quantitative parameters have been determined, EN ISO 13849-1 proposes a simple graphical method for determining the achieved PL for the SRP/CS.

The combination of requirements to achieve PL:

		Category						
		B	1	2		3		4
Performance Level PL	a							
	b							
	c							
	d							
	e							
DCavg=		None	None	Low	Medium	Low	Medium	High
CCF=		Not relevant		CCF ≥ 65%				

Operational and safety components

The EU has produced guidance about the difference between these components as stated below:

“Many machinery components are critical for the health and safety of persons. However purely operational components are not considered as safety components. Safety components are components intended by the component manufacturer to be fitted to machinery specifically to fulfil a protective role. Components placed independently on the market that are intended by the component manufacturer for functions that are both safety and operational functions, or that are intended by the component manufacturer to be used either for safety or for operational functions are to be considered as safety components.”

SMC clearly states which components are intended for safety functions and are hence “safety components”. SMC does not intend operational components to be used for safety functions.

SMC Role and Support

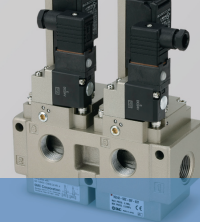

SMC supports equipment manufacturers and end users considering safety design of equipment and machines, helping with equipment selection, providing products related to the safety control system, and also data about the life of equipment.

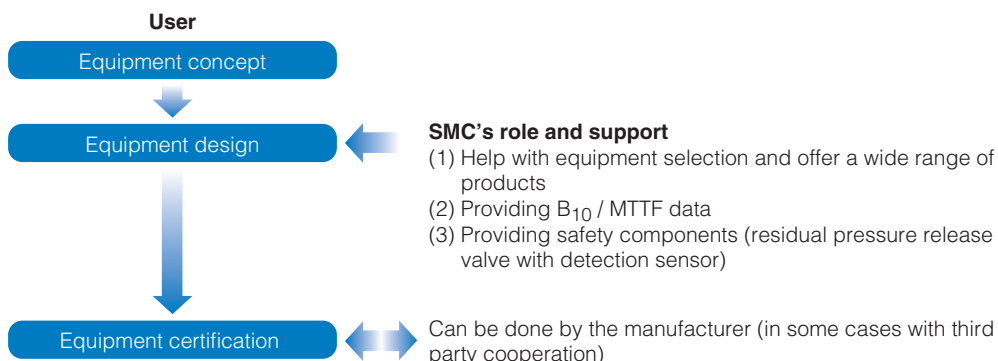

Helping with equipment selection

SMC offers a full line-up of products to help reduce risks of machinery.

Providing MTTF / B_{10} data

SMC calculates and provides reliability characteristics values concerning life of individual parts. Equipment manufacturers and users should convert this to MTTFd data, and use it to evaluate PL.

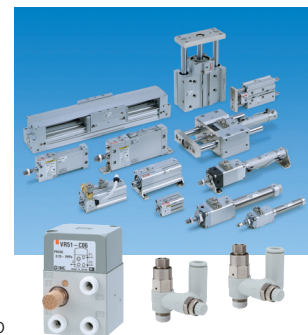

B_{10} data (MTTF only for electronic equipment that does not have wear-out failure).

The reliability characteristics values (B_{10} or MTTF) provided by SMC are values particular to the components to be used.

The customer should separately convert these into the parameters for assessing the safety category (B_{10d} , MTTFd) within the equipment design specification.

These values are obtained under SMC's standard (SMC internal test conditions), and are not guaranteed under the operating conditions of the customer's equipment.

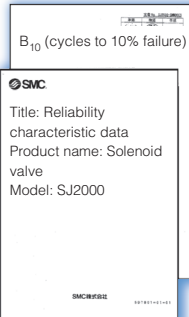

Providing safety components

Safety system valves: dual residual pressure release valves with position detection sensor: VP544-□-X538; VG744-□-X538; VG342-□-X87.

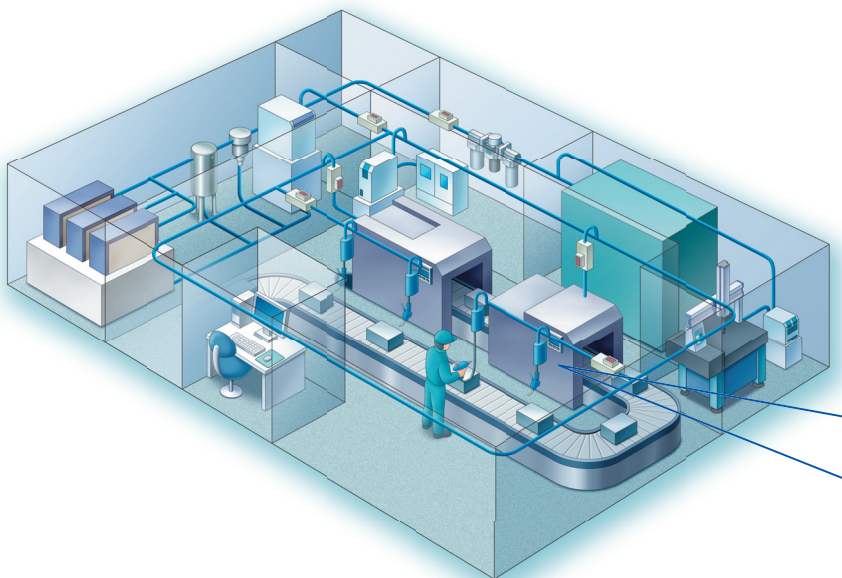

What is a dual residual pressure release valve with position detection sensor?

Two 3-port valves with switches to check the movement of the main valve are connected in series, so even if one of them fails to operate, the other one can safely release the residual pressure. The spool position switches indicate if one valve has failed to operate and can be used to prevent the reenergizing of the system until repaired.

VG342-□-X87



VP544-□-X538

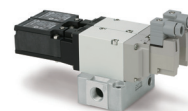

Position detection valve with redundancy

SMC Safety System Valves

Series VP542-X536 / VP742-X536

Residual pressure release valve - 3 port solenoid valve

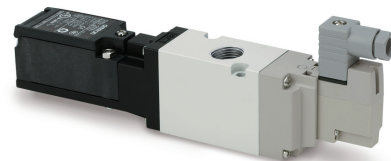

Features

- Safety Standards ISO13849-1 for Category 2
This product is designed to be used as a component in a Category 2 safety system. The single unit alone cannot be considered as a Category 2 safety system.
- Valve position energised/de-energised can be detected
The detecting function of the main valve is available to detect error in the input signal and valve operation

How to order

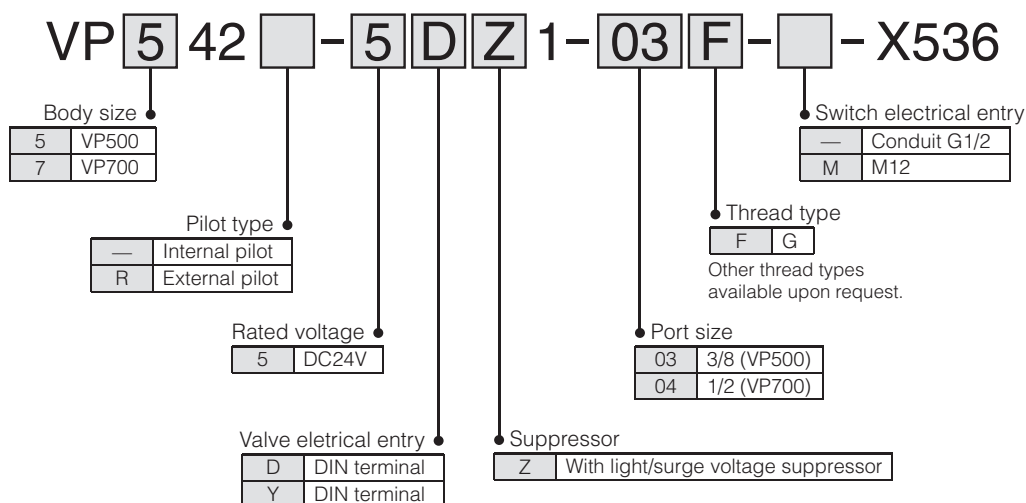

Specifications

Summary specifications - for full specifications refer to SMC ^{Note 1)}

Model	VP542-X536 ^{Note 2)} VP742-X536 ^{Note 2)}	VP542R-X536 VP742R-X536
Fluid	Air	
Type of actuation	NC (spring return)	
Operating pressure range	0.25 to 0.7 MPa	
Operation	Internal pilot type	External pilot type
External pilot pressure	—	0.25 to 0.7 MPa
Maximum operating frequency	30 times/min	
Minimum operating frequency	1 time/week	
Ambient and fluid temperature	-10 to +50°C (no freezing)	
Ambient	20 to 90% RH (no freezing)	
Lubrication	Not required	
Shock / vibration	150 / 30 m/s ²	
Enclosure	IP65	
Operating environment	Indoors	
Weight	VP542(R)-X536: 350 g; VP742(R)-X536: 590 g	
B _{10d} (MTTF _d calculation)	1.000.000 cycles	

Note 1) Subject to change

Note 2) Pilot pressure must be greater than or equal to the operating pressure.

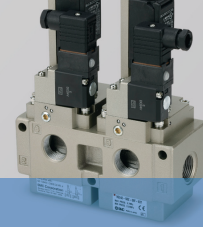

Fluid

Model	VP542(R)-X536		VP742(R)-X536	
	1 → 2 (P → A)	2 → 3 (A → R)	1 → 2 (P → A)	2 → 3 (A → R)
Operating pressure				
C [dm ³ /(s·bar)]	8.9	8.9	15.1	15.3
b	0.16	0.20	0.21	0.22
Cv	2.2	2.1	3.6	3.7
Q [L/min] (ANR) <small>note)</small>	2085	2132	2637	3707

Note) These valves have been calculated according to ISO 6358 and indicate the flow rate under Standard conditions with an inlet pressure of 0.6 MPa (relative pressure) and a pressure drop of 0.1 MPa.

Solenoid Specifications

Electrical entry	DIN terminal
Rated voltage	24 VDC
Allowable voltage fluctuation	-7% to +10%
Power consumption	0.45 W
Surge voltage suppressor	Varistor
Indicator	LED

Limit switch Specifications

Electrical wiring	Conduit G1/2, M12 connector
Contact resistance	25 mΩ or less
Minimum applicable load	5 VDC, 1 mA (load resistance)
Maximum voltage	24 VDC
Maximum load current	50 mA
Maximum load inductance	0.5 H
Insulation voltage	300 V
Protection against electric shock	Class II (EN60947-5-1:2004)

Symbol

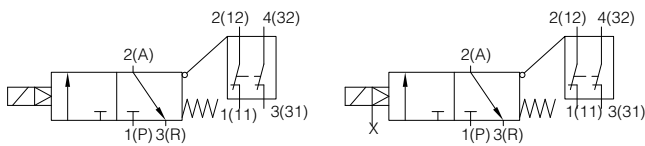

Dimensions

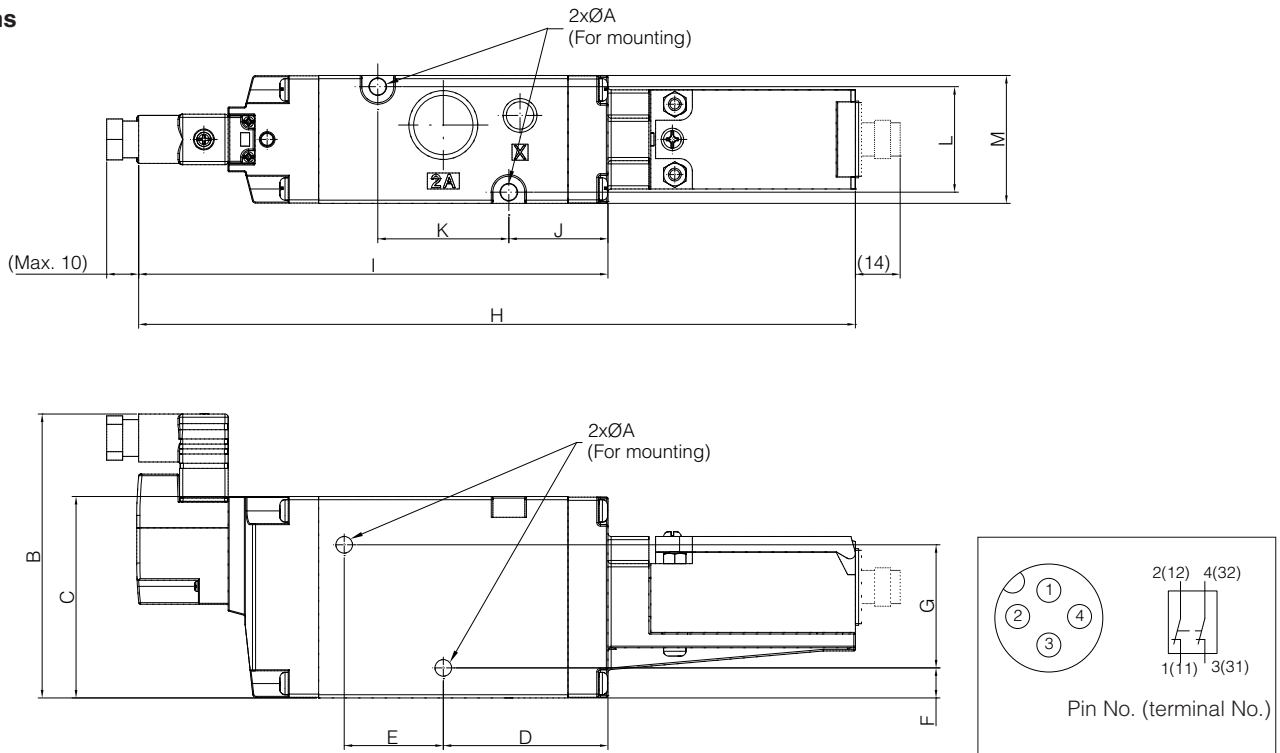

	[mm]												
Size	A	B	C	D	E	F	G	H	I	J	K	L	M
VP542(R)-X536	4.20	70.80	45	39.60	23.50	4	31.50	201.80	124.00	25.60	31	26	31
VP742(R)-X536	5.20	88.80	63	51.50	31	9.40	38.50	224.20	146.80	31	41	33	40

Series VP544-X538 / VP744-X538

Dual residual pressure release valve - 3 port solenoid valve

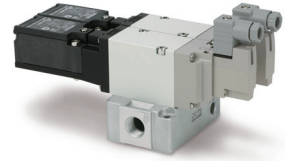

Features

- Safety Standards ISO13849-1 for Category 3 and 4
This product is designed to be used as a component in a Category 3,4 safety system. The single unit alone cannot be considered as a Category 3,4 safety system.
- Valve position energised/de-energised can be detected
- Redundancy
Valve has 2 stations, so if one of them fails to operate, residual pressure is released by the remaining valve
- Modular connection to FRL unit

How to order

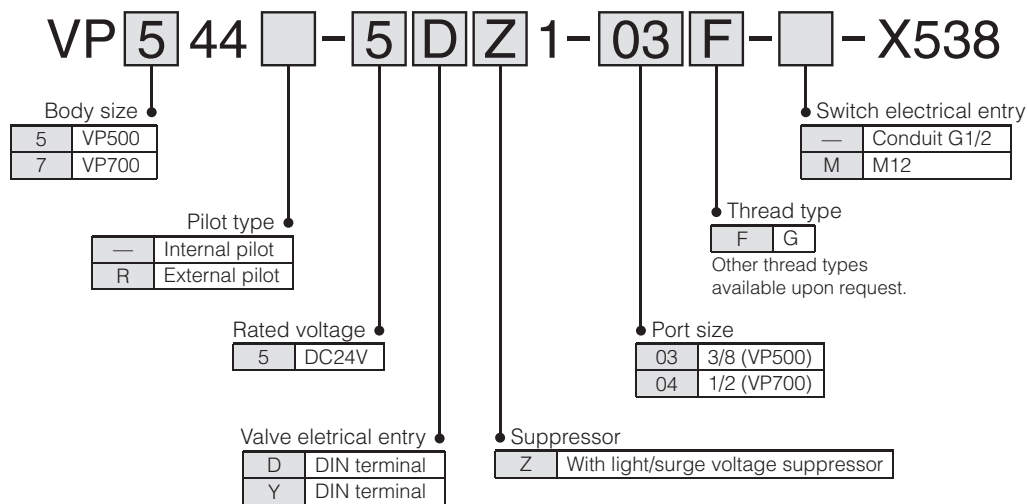

Specifications

Summary specifications - for full specifications refer to SMC ^{Note 1)}

Model	VP544-X538 ^{Note 2)} VP744-X538 ^{Note 2)}	VP544R-X538 VP744R-X538
Fluid	Air	
Type of actuation	NC (spring return)	
Operating pressure range	0.25 to 0.7 MPa	
Operation	Internal pilot type	External pilot type
External pilot pressure	—	0.25 to 0.7 MPa
Maximum operating frequency	30 times/min	
Minimum operating frequency	1 time/week	
Ambient and fluid temperature	-10 to +50°C (no freezing)	
Ambient	20 to 90% RH (no freezing)	
Lubrication	Not required	
Shock / vibration	150 / 30 m/s ²	
Enclosure	IP65	
Operating environment	Indoors	
Weight	VP544-X538: 930 g; VP744-X538: 1510 g	
B _{10d} (MTTF _d calculation)	1.000.000 cycles	

Note 1) Subject to change

Note 2) Pilot pressure must be greater than or equal to the operating pressure.

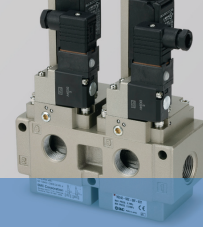

Fluid

Model	VP544(R)-X538		VP744(R)-X538	
	1 → 2 (P → A)	2 → 3 (A → R)	1 → 2 (P → A)	2 → 3 (A → R)
Operating pressure				
C [dm ³ /(s·bar)]	6.5	6.7	10.3	9.7
b	0.08	0.10	0.08	0.08
Cv	1.3	1.3	2.3	2.1
Q [L/min] (ANR) ^{note}	1461	1621	2315	2180

Note) These valves have been calculated according to ISO 6358 and indicate the flow rate under Standard conditions with an inlet pressure of 0.6 MPa (relative pressure) and a pressure drop of 0.1 MPa.

Solenoid Specifications

Electrical entry	DIN terminal
Rated voltage	24 VDC
Allowable voltage fluctuation	-7% to +10%
Power consumption	0.45 W
Surge voltage suppressor	Varistor
Indicator	LED

Limit switch Specifications

Electrical wiring	Conduit G1/2, M12 connector
Contact resistance	25 mΩ or less
Minimum applicable load	5 VDC, 1 mA (load resistance)
Maximum voltage	24 VDC
Maximum load current	50 mA
Maximum load inductance	0.5 H
Insulation voltage	300 V
Protection against electric shock	Class II (EN60947-5-1:2004)

Symbol

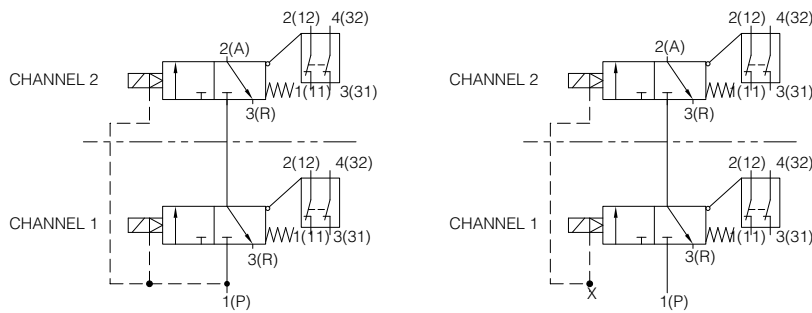

Dimensions

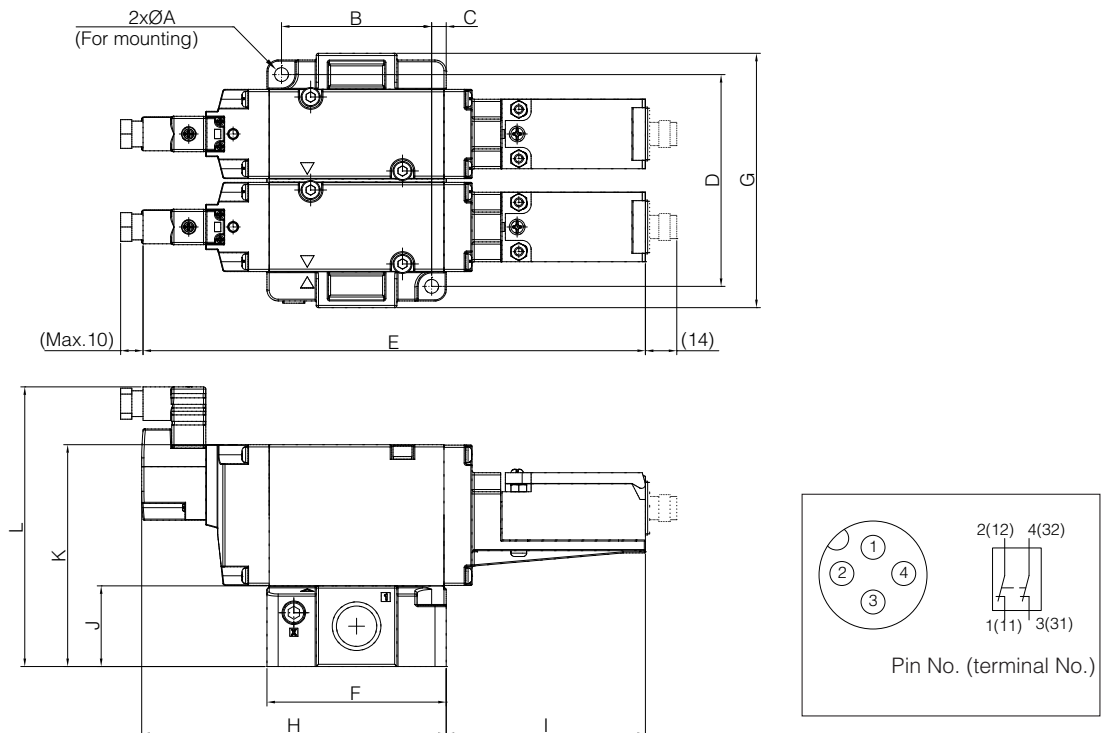

Size	[mm]											
	A	B	C	D	E	F	G	H	I	J	K	L
VP544(R)-X538	5.20	47	5.00	75.50	201.80	57	91.50	112.00	90.40	34	79	104.80
VP744(R)-X538	6.20	67	6.50	94.50	224.20	80	113.50	135.90	88.9	36	99	124.80

Series VG342-X87

Dual residual pressure release valve - 3 port solenoid valve

Features

- Safety Standard ISO13849-1 for Category 3 and 4, compliant with performance level e
This product is designed to be used as a component in a Category 3,4 safety system. The single unit alone cannot be considered as a Category 3,4 safety system.
- Valve position energised/de-energised can be detected
- Redundancy
Valve has 2 stations, so if one of them fails to operate, residual pressure is released by the remaining valve
- Modular connection to FRL unit



How to order

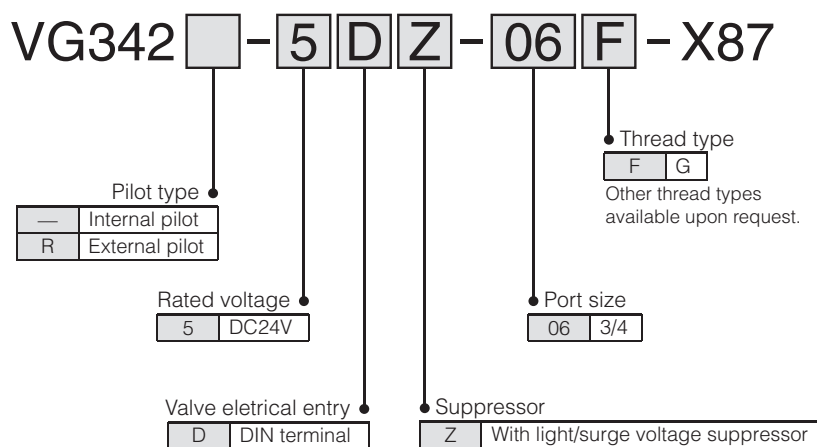

Specifications

Summary specifications - for full specifications refer to SMC ^{Note 1)}

Model	VG342-X87 ^{Note 2)}	VG342R-X87
Fluid	Air	
Type of actuation	NC (spring return)	
Operating pressure range	0.25 to 0.7 MPa	
Operation	Internal pilot type	External pilot type
External pilot pressure	—	0.25 to 0.7 MPa
Maximum operating frequency	30 times/min	
Minimum operating frequency	1 time/week	
Ambient and fluid temperature	-10 to +50°C (no freezing)	
Ambient	95% or less (no freezing)	
Lubrication	Not required	
Shock / vibration	150 / 50 m/s ²	
Enclosure	IP40	
Operating environment	Indoors	
Weight	2.8 kg	2.9 kg
B _{10d} (MTTF _d calculation)	900.000 cycles	

Note 1) Subject to change

Note 2) Pilot pressure must be greater than or equal to the operating pressure.

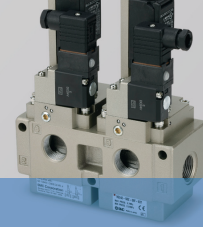

Fluid

Operating pressure	1 → 2 (P → A) [ℓ/min (ANR)]	2 → 3 (A → R) [ℓ/min (ANR)]
0.25 MPa	3800	5200
0.5 MPa	7400	9400
0.7 MPa	10000	13000

Solenoid Specifications

Electrical entry	DIN terminal
Rated voltage	24 VDC
Allowable voltage fluctuation	-15% to +10%
Power consumption	2.2 W
Suppressor	Light/surge voltage suppressor

Limit switch Specifications

Electrical wiring	M12 connector
Contact resistance	25 mΩ or less
Minimum applicable load	5 VDC, 1 mA (load resistance)
Maximum voltage	24 VDC
Maximum load current	50 mA
Maximum load inductance	0.5 H
Insulation voltage	300 V
Protection against electric shock	Class II (EN60947-5-1:2004)

Symbol

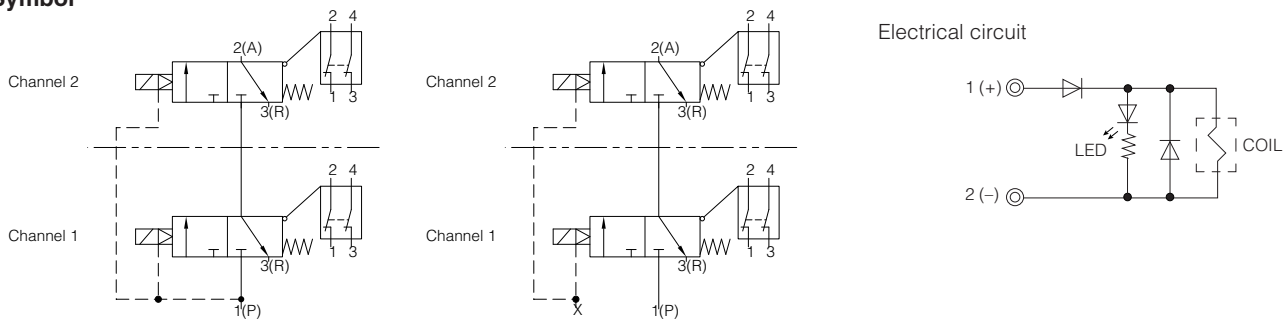

Dimensions

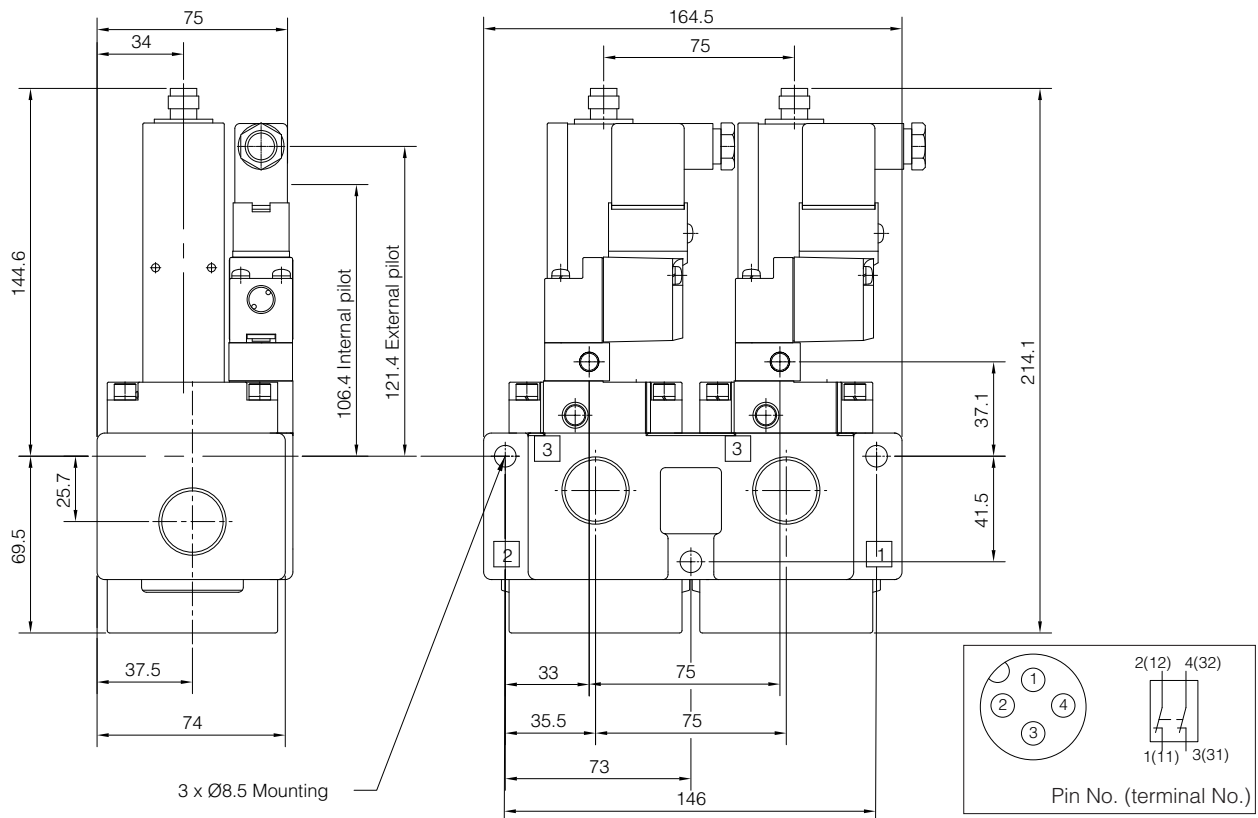

SMC Related Product

Safety components

Apart from VP□42-X536, VP□44-X538, and VG342-X87 series, SMC has other safety components products.

Two hand control valve Series VR51



- To initiate machine operation while ensuring operator hands are in safe area.
- Certified type IIIA according to EN574.

Possible circuit for the control of a cylinder:

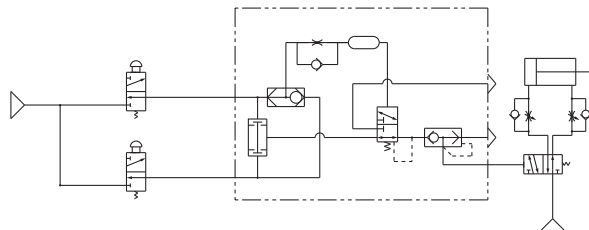

Operational Components

The machine designer can use operational components in safety applications, but the suitability for the safety application is the responsibility of the machine designer.

Speed controller with pilot check valve Series ASP



- Allows temporary speed control of cylinder, preventing intermediate stop/drop.
- **ASP-X352**: special product that incorporates a button to evacuate residual pressure of the actuators.

Shuttle valve Series VR12□0F



- Control of air pressure signal system lines: high pressure air is always output to the OUT side.
- Application examples: interlock circuit, self holding circuit.

2 position valve Series VQC2101NY-5-X10

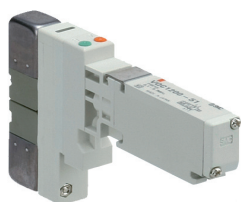

- The valve is designed to return to a defined state when de-energised.

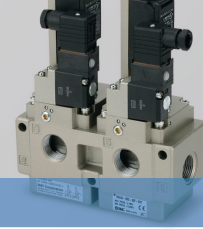

Pressure switch / reed switch type
Series IS10



- Turns on when the pressure exceeds the set pressure range.

Reed auto-switch
Series D-A93
Solid state auto-switch
Series D-M9
Solid state auto-switch, water resistant
Series D-M9A



- Detects the position of actuators.

Soft start-up valve
Series EAV



- Integrated pressure release function & high relief capacity: possible to cut off supply for rapid exhaust.
- Adjustable bleed orifice.
- Pressure gauge can be fitted.
- Low power consumption.
- Available both in electric and pneumatic operated versions.
- Connectable with modular type FRL combination unit.

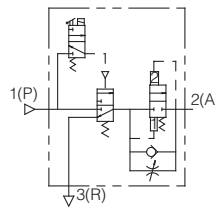

Residual pressure release valve
Series KE□



- Residual pressure can be instantly released by pressing a button on the product.

Check valve
Series AK



- Allows temporary stop of cylinder, preventing intermediate stop/drop.

Speed control valve
Series ASS

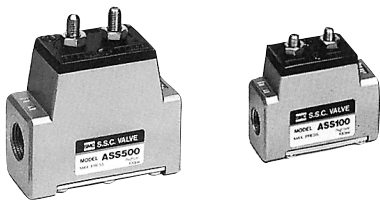

- Meter out type: a control valve with cylinder speed control, fixed throttle and rapid air supply function.
- Meter in type: a control valve with cylinder speed control function and rapid air supply function.

Dual speed controller
Series ASD



- Flow control is possible in two directions.

Speed controller
Series AS□□□1F



- Residual pressure can be instantly released by pressing a button on the product.
- Prevents unintended manual operation.

AS□□□1FE: speed controller with residual pressure release valve with one-touch fitting

AS□□□1F-D: speed controller adjustable by flat head screwdriver

AS□□□1F-T: tamper proof speed controller

Residual pressure indicator for air
Series CB-97XH



- Allows visual confirmation of residual pressure in cylinder, production line.

5 Port solenoid valve
Series SY3000/5000

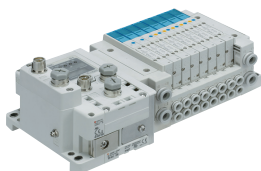

- Integral cross-port check valve feature available to maintain actuator position.
- Air supply isolation of individual valves option available.
- Integral check valve to isolated actuator from common exhaust back-pressure.

5 Port solenoid valve
Series VQC



- Integral check valve to isolated actuator from common exhaust back-pressure.

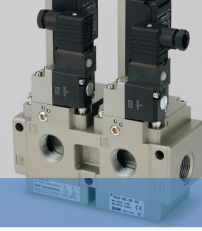

ISO13849-1



SMC CORPORATION (Europe)

Austria	☎ +43 (0)2262622800	www.smc.at	office@smc.at	Lithuania	☎ +370 5 2308118	www.smclt.lt	info@smclt.lt
Belgium	☎ +32 (0)33551464	www.smcpn pneumatics.be	info@smcpneumatics.be	Netherlands	☎ +31 (0)205318888	www.smcpn pneumatics.nl	info@smcpneumatics.nl
Bulgaria	☎ +359 (0)2807670	www.smc.bg	office@smc.bg	Norway	☎ +47 67129020	www.smc-norge.no	post@smc-norge.no
Croatia	☎ +385 (0)13707288	www.smc.hr	office@smc.hr	Poland	☎ +48 (0)222119616	www.smc.pl	office@smc.pl
Czech Republic	☎ +420 541424611	www.smc.cz	office@smc.cz	Portugal	☎ +351 226166570	www.smc.eu	postpt@smc.smces.es
Denmark	☎ +45 70252900	www.smc.dk.com	smc@smcdk.com	Romania	☎ +40 213205111	www.smcromania.ro	smcromania@smcromania.ro
Estonia	☎ +372 6510370	www.smcpn pneumatics.ee	smc@smcpneumatics.ee	Russia	☎ +7 8127185445	www.smc-pneumatik.ru	info@smc-pneumatik.ru
Finland	☎ +358 207513513	www.smc.fi	smcfi@smc.fi	Slovakia	☎ +421 (0)413213212	www.smc.sk	office@smc.sk
France	☎ +33 (0)164761000	www.smc-france.fr	promotion@smc-france.fr	Slovenia	☎ +386 (0)73885412	www.smc.si	office@smc.si
Germany	☎ +49 (0)61034020	www.smc.de	info@smc.de	Spain	☎ +34 902184100	www.smc.eu	post@smc.smces.es
Greece	☎ +30 210 2717265	www.smchellas.gr	sales@smchellas.gr	Sweden	☎ +46 (0)86031200	www.smc.nu	post@smc.nu
Hungary	☎ +36 23511390	www.smc.hu	office@smc.hu	Switzerland	☎ +41 (0)523963131	www.smc.ch	info@smc.ch
Ireland	☎ +353 (0)14039000	www.smcpn pneumatics.ie	sales@smcpneumatics.ie	Turkey	☎ +90 212 489 0 440	www.smcpnomatik.com.tr	info@smc pnomatik.com.tr
Italy	☎ +39 0292711	www.smcitalia.it	mailbox@smcitalia.it	UK	☎ +44 (0)845 121 5122	www.smcpn pneumatics.co.uk	sales@smcpneumatics.co.uk
Latvia	☎ +371 67817700	www.smclv.lv	info@smclv.lv				

EMC-P-E11-4A-UK