









Ficha técnica

Rueda ZV-PS 2-0870

Codigo				Tipo cojinete Eje					
2-0870	125	125	35	—	107x86	80x60	8	155	-



Características

Chapa de acero hasta 4mm de espesor.
Acabado cincado brillante.
Soporte embutido con doble hilera de bolas.
Modelo de uso universal para cargas medias.
Fabricadas según normas europeas EN 12530/12532.

Datos técnicos

Diámetro: 125 mm
Carga: 125 kg
Tipo de cojinete: Cojinete Liso
Ancho de Banda de rodadura: 35 mm
Medidas de placa superior: 107x86 mm
Distancia entre agujeros: 80x60 mm
Diámetro agujero sujeción platina: 8 mm
Altura total: 155 mm

Archivos CAD

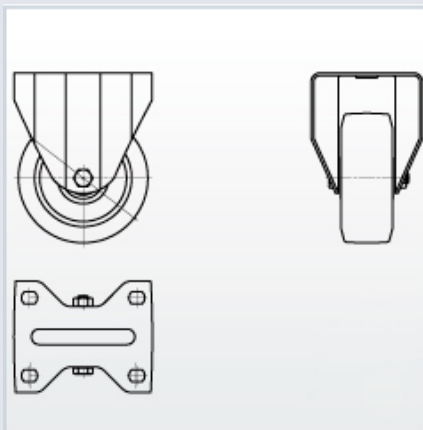
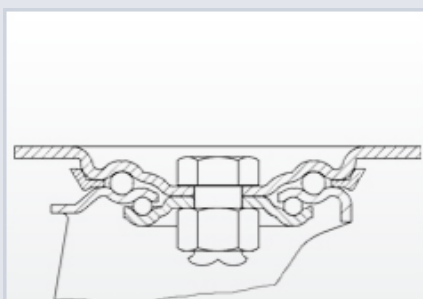

Rueda

PS (Goma)
Núcleo de poliamix y banda de goma
Rango de temperatura: -20° ÷ +60°

Productos relacionados

