

Actuator/sensor cable, PUR
Connection cable
WKS4.5T-2/TXL

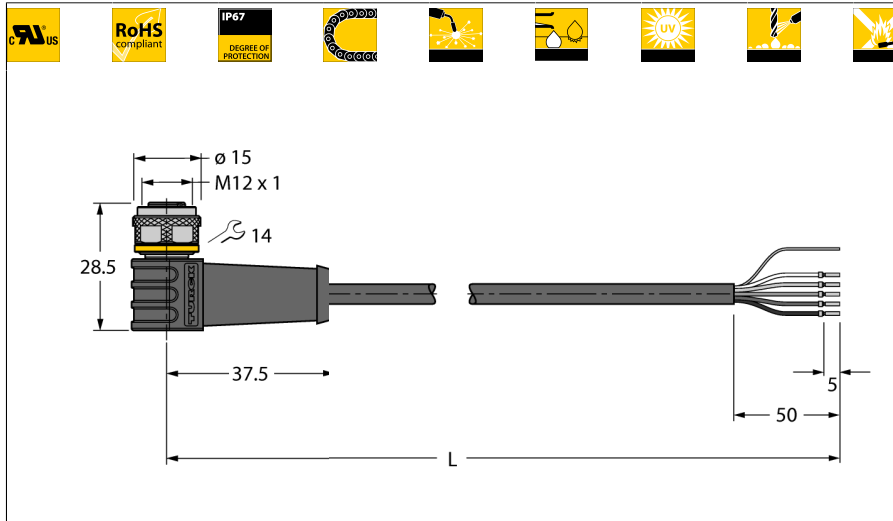

- Female M12, angled, 5-pin
- Shield on coupling nut/screw
- Sheath material: PUR, shielded
- Sheath color: black
- Qualified for drag chain use
- Resistant to weld splatter
- Resistant to chemicals, UV radiation and oils
- Flame retardant
- Free from halogen, silicone, PVC and LABS
- Particularly resistant to abrasion
- Approval: cULus
- RoHS conform
- Protection class IP67
- Cable length: 2.0 m

| | |
|-------------------------|---------------|
| Type designation | WKS4.5T-2/TXL |
| Ident no. | 6626376 |

| | |
|-------------------------|---|
| Connector A side | Female connector, M12 ⤵ 1, Angled |
| Number of pins | 5 |
| Contacts | Brass, CuZn, Gold-plated |
| Contact carriers | Plastic, TPU, Black |
| Grip | Plastic, TPU, Black |
| Coupling nut/screw | Brass, CuZn, Nickel-plated |
| Seal | Plastic, FPM/FKM |
| Protection class | IP67, A + B side screwed together |
| Mechanical lifespan | > 100 Mating cycles |
| Pollution degree | 3 |
| Tightening torque | 0.8 ... 1 Nm (observe max. torque of counter piece!) |

Cable Cross-section

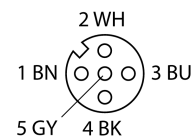
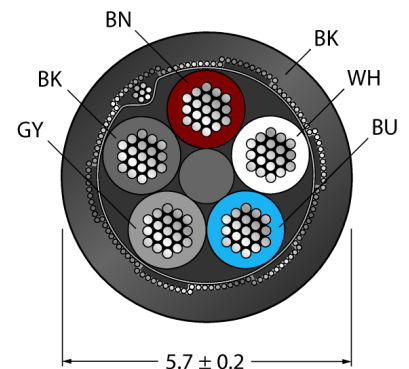

| | |
|------------------------|-----------------------------------|
| General data | |
| Cable diameter | 5.7 ± 0.20mm |
| Cable length | 2 m |
| Cable quality | PUR |
| Cable color | Black |
| Core insulation | PP |
| Core colors | BN, WH, BU, BK, GY |
| Core cross-section | 5x0.34mm ² |
| Arrangement of strands | 42x0.1 mm |
| Shielding | Aluminum foil, tinned copper wire |

| | |
|--------------------------------------|--------------|
| Electrical features at +20 °C | |
| Current | 4 A |
| Rated voltage | 60 V |
| Insulation resistance | > 30.5 MΩ/km |
| Test voltage | 2000 V |
| Forward resistance | max. 57 Ω/km |

Drawing shows design status including hexagon coupling nut (Start of production CW42/2016).

Circuit Diagram

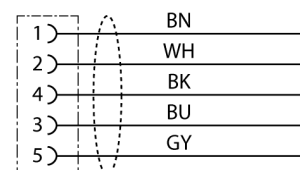

Actuator/sensor cable, PUR
Connection cable
WKS4.5T-2/TXL

TURCK





Industrial
Automation

Mechanical and chemical properties

| | |
|------------------------------------|------------------------------|
| Max. tensile strength (static) | ≤ 50 N/mm ² |
| Max. tensile strength (dynamic) | ≤ 20 N/mm ² |
| Bending cycles | > 2 mil. |
| Bending radius (stationary laying) | > 5 x Ø |
| Bending radius (flexible use) | > 10 x Ø |
| Admissible acceleration | max. 5 m/s ² |
| Admissible travel path, horizontal | 5 m (at 5 m/s ²) |
| Admissible travel path, vertical | 2 m (at 5 m/s ²) |
| Admissible traversing speed | 3.3 m/s |
| Torsional stress | ± 180 °/m |
| Ambient temperature | |
| Stationary | -50...+80°C |
| In motion | -25...+80°C |
| Drag chain operation | -25...+60°C |

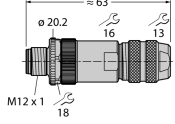
Actuator/sensor cable, PUR
Connection cable
WKS4.5T-2/TXL

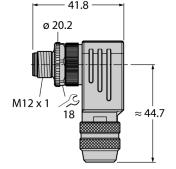
Accessories

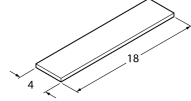
| Type code | Ident no. | Description | |
|----------------------------------|-----------|--|---|
| CMBS8151-0 | 6930161 | Field-wireable male connector, M12  , straight, 5-pin, screw terminal connection, cable feedthrough 6.0 to 8.0 mm, core cross-section/terminal capacity 0.14 to 0.75 mm ² , metal housing, metal nut, shieldable |  |
| CMBS8251-0 | 6930216 | Field-wireable male connector, M12  , angled, 5-pin, screw terminal connection, cable feedthrough 6.0 to 8.0 mm, core cross-section/terminal capacity 0.14 to 0.75 mm ² , metal housing, metal nut, shieldable |  |
| Torque-Wrench-Set-AS | 6936170 | Torque wrench set; handles with adjustable torque 0.4-1.0 Nm, torque wrench for M8 (SW9), fork wrench for M12 (SW 14) |  |
| BLANK-LABEL-FOR-CORDSETS-TEL-TXL | 6936206 | Label for TEL and TXL cables, length: 18 mm, height: 4 mm, material: polycarbonate (PC), color: white, halogen-free and flame-retardant |  |