

angular milling cutter 90° VSM490™-15 with thread

for indexable milling inserts XN.U 15T6..

WIDIA 

Application:

the WIDIA™ Victory™ angular milling cutter range VSM490™-10 or 15 has been specifically developed for higher cutting volumes and excellent surface qualities of plane surfaces and shoulders. the 90° angular milling cutters are suitable for a wide range of material applications – steel, cast iron, stainless steel and titanium – for machining ranging from roughing to finishing.

Execution:

- double-sided, robust indexable insert with four cutting edges
- highly positive geometry for lower cutting forces
- excellent surface quality on shoulder and front surface
- with internal cooling

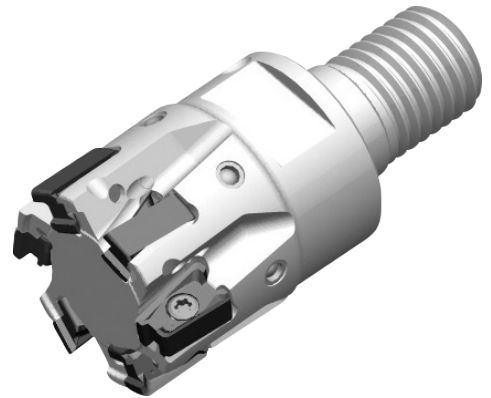

Art. no.	16043 606
Brand	WIDIA
Manufacturer Part Number	5873214
Cutting edge diameter	35 mm
Clearance length	40 mm
Thread dimension	M16
max. ap	15 mm
Number of cutting edges	4 PCS
Gross Weight	0.190 kg
Product Group	1XJ

EAN

4050841730549