

# Operating Instructions

## RMA42

Process transmitter





## Table of contents

<b>1</b>	<b>About this document</b> .....	<b>4</b>	<b>10</b>	<b>Repair</b> .....	<b>43</b>
1.1	Symbols .....	4	10.1	General notes .....	43
1.2	Documentation .....	5	10.2	Spare parts .....	43
<b>2</b>	<b>Safety instructions</b> .....	<b>7</b>	10.3	Return .....	44
2.1	Requirements for the personnel .....	7	10.4	Disposal .....	44
2.2	Intended use .....	7	<b>11</b>	<b>Accessories</b> .....	<b>46</b>
2.3	Workplace safety .....	7	11.1	Communication-specific accessories .....	46
2.4	Operational safety .....	7	<b>12</b>	<b>Technical data</b> .....	<b>47</b>
2.5	Product safety .....	8	12.1	Input .....	47
<b>3</b>	<b>Incoming acceptance and product identification</b> .....	<b>9</b>	12.2	Output .....	47
3.1	Incoming acceptance .....	9	12.3	Power supply .....	49
3.2	Product identification .....	9	12.4	Performance characteristics .....	50
3.3	Certificates and approvals .....	9	12.5	Installation .....	51
3.4	Storage and transport .....	10	12.6	Environment .....	52
<b>4</b>	<b>Mounting</b> .....	<b>11</b>	12.7	Mechanical construction .....	53
4.1	Installation requirements .....	11	12.8	Operability .....	54
4.2	Dimensions .....	11	12.9	Certificates and approvals .....	55
4.3	Mounting procedure .....	12	<b>13</b>	<b>Appendix</b> .....	<b>56</b>
4.4	Post-installation check .....	12	13.1	Further explanations regarding the differential pressure application in level measurement .....	56
<b>5</b>	<b>Wiring</b> .....	<b>13</b>	13.2	Display menu .....	58
5.1	Electrical connection .....	13	13.3	Setup menu .....	59
5.2	Post-connection check .....	16	13.4	Diagnostics menu .....	68
<b>6</b>	<b>Operation</b> .....	<b>17</b>	13.5	Expert menu .....	70
6.1	Operating elements .....	17	<b>Index</b> .....	<b>77</b>	
6.2	Display and device status indicator / LED .....	19			
6.3	Symbols .....	20			
6.4	Quick guide to the operating matrix .....	21			
<b>7</b>	<b>Commissioning</b> .....	<b>24</b>			
7.1	Post-installation check and switching on the device .....	24			
7.2	General information about configuring the device .....	24			
7.3	Notes on setup access protection .....	24			
7.4	Device configuration .....	25			
7.5	In operation .....	37			
<b>8</b>	<b>Diagnostics and troubleshooting</b> ...	<b>41</b>			
8.1	General troubleshooting .....	41			
8.2	Overview of diagnostic information .....	41			
8.3	Diagnosis list .....	41			
<b>9</b>	<b>Maintenance</b> .....	<b>42</b>			

# 1 About this document

## 1.1 Symbols

### 1.1.1 Safety symbols

#### **DANGER**

This symbol alerts you to a dangerous situation. Failure to avoid this situation will result in serious or fatal injury.

#### **WARNING**

This symbol alerts you to a dangerous situation. Failure to avoid this situation can result in serious or fatal injury.





#### **CAUTION**

This symbol alerts you to a dangerous situation. Failure to avoid this situation can result in minor or medium injury.







#### **NOTICE**







This symbol contains information on procedures and other facts which do not result in personal injury.

### 1.1.2 Electrical symbols





Symbol	Meaning
	Direct current
	Alternating current
	Direct current and alternating current
	<b>Ground connection</b> A grounded terminal which, as far as the operator is concerned, is grounded via a grounding system.
	<b>Potential equalization connection (PE: protective earth)</b> Ground terminals that must be connected to ground prior to establishing any other connections.  The ground terminals are located on the interior and exterior of the device: <ul style="list-style-type: none"> <li>▪ Interior ground terminal: potential equalization is connected to the supply network.</li> <li>▪ Exterior ground terminal: device is connected to the plant grounding system.</li> </ul>

### 1.1.3 Symbols for certain types of information

Symbol	Meaning
	<b>Permitted</b> Procedures, processes or actions that are permitted.
	<b>Preferred</b> Procedures, processes or actions that are preferred.
	<b>Forbidden</b> Procedures, processes or actions that are forbidden.
	<b>Tip</b> Indicates additional information.
	Reference to documentation
	Reference to page

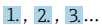
Symbol	Meaning
	Reference to graphic
	Notice or individual step to be observed
	Series of steps
	Result of a step
	Help in the event of a problem
	Visual inspection

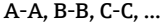
### 1.1.4 Symbols in graphics

Symbol	Meaning	Symbol	Meaning
	Item numbers		Series of steps
	Views		Sections
	Hazardous area		Safe area (non-hazardous area)

## 1.2 Documentation

Document	Purpose and content of the document
Technical Information (TI)	<b>Planning aid for your device</b> The document contains all the technical data on the device and provides an overview of the accessories and other products that can be ordered for the device.
Brief Operating Instructions (KA)	<b>Guide that takes you quickly to the 1st measured value</b> The Brief Operating Instructions contain all the essential information from incoming acceptance to initial commissioning.
Operating Instructions (BA)	<b>Your reference document</b> The Operating Instructions contain all the information that is required in various phases of the life cycle of the device: from product identification, incoming acceptance and storage, to mounting, connection, operation and commissioning through to troubleshooting, maintenance and disposal.
Description of Device Parameters (GP)	<b>Reference for your parameters</b> The document provides a detailed explanation of each individual parameter. The description is aimed at those who work with the device over the entire life cycle and perform specific configurations.

Document	Purpose and content of the document
Safety Instructions (XA)	<p>Depending on the approval, Safety Instructions (XA) are supplied with the device. The Safety Instructions are an integral part of the Operating Instructions.</p> <p> Information on the Safety Instructions (XA) that are relevant for the device is provided on the nameplate.</p>
Supplementary device-dependent documentation (SD/FY)	<p>Additional documents are supplied depending on the device version ordered: Always comply strictly with the instructions in the supplementary documentation. The supplementary documentation is an integral part of the device documentation.</p>

-  The document types listed are available:
- In the Download Area of the Endress+Hauser Internet site: [www.endress.com](http://www.endress.com) → Download
  - Enter the serial number from the nameplate in the W@M Device Viewer ([www.endress.com/deviceviewer](http://www.endress.com/deviceviewer)): all data relating to the device and an overview of the Technical Documentation supplied with the device are displayed.
  - Enter the serial number on the nameplate into the Endress+Hauser Operations app or scan the 2-D matrix code (QR code) on the nameplate with the Endress+Hauser Operations app: all data relating to the device and the Technical Documentation pertaining to the device is displayed.

## 2 Safety instructions

### 2.1 Requirements for the personnel

The personnel for installation, commissioning, diagnostics and maintenance must fulfill the following requirements:

- ▶ Trained, qualified specialists must have a relevant qualification for this specific function and task.
- ▶ Are authorized by the plant owner/operator.
- ▶ Are familiar with federal/national regulations.
- ▶ Before starting work, read and understand the instructions in the manual and supplementary documentation as well as the certificates (depending on the application).
- ▶ Follow instructions and comply with basic conditions.

The operating personnel must fulfill the following requirements:

- ▶ Are instructed and authorized according to the requirements of the task by the facility's owner-operator.
- ▶ Follow the instructions in this manual.

### 2.2 Intended use

The process transmitter evaluates analog process variables and displays them on its multicolored screen. Processes can be monitored and controlled with the device's outputs and limit relays. The device is equipped with a wide array of software functions for this purpose. Power can be supplied to 2-wire sensors with the integrated loop power supply.

- The device is an associated apparatus and may not be installed in the hazardous area.
- The manufacturer accepts no liability for damages resulting from incorrect use or use other than that intended. It is not permitted to convert or modify the device in any way.
- The device is designed for operation in an industrial environment and may only be operated in an installed state.

### 2.3 Workplace safety

When working on and with the device:

- ▶ Wear the required personal protective equipment as per national regulations.

### 2.4 Operational safety

Risk of injury!

- ▶ Operate the device only if it is in proper technical condition, free from errors and faults.
- ▶ The operator is responsible for the interference-free operation of the device.

#### Modifications to the device

Unauthorized modifications to the device are not permitted and can lead to unforeseeable dangers!

- ▶ If modifications are nevertheless required, consult with the manufacturer.

#### Repair

To ensure continued operational safety and reliability:

- ▶ Carry out repairs on the device only if they are expressly permitted.
- ▶ Observe federal/national regulations pertaining to the repair of an electrical device.
- ▶ Use only original spare parts and accessories.

## **2.5 Product safety**

This product is designed in accordance with good engineering practice to meet state-of-the-art safety requirements and has been tested and left the factory in a condition in which it is safe to operate.



## 3 Incoming acceptance and product identification

### 3.1 Incoming acceptance

Proceed as follows on receipt of the device:

1. Check whether the packaging is intact.
2. If damage is discovered:  
Report all damage immediately to the manufacturer.
3. Do not install damaged material, as the manufacturer cannot otherwise guarantee compliance with the safety requirements and cannot be held responsible for the consequences that may result.
4. Compare the scope of delivery to the contents of the order.
5. Remove all the packaging material used for transportation.

### 3.2 Product identification

The device can be identified in the following ways:

- Nameplate specifications
- Extended order code with breakdown of the device features on the delivery note
- Enter the serial number from the nameplate in the *W@M Device Viewer* ([www.endress.com/deviceviewer](http://www.endress.com/deviceviewer)): all data relating to the device and an overview of the Technical Documentation supplied with the device are displayed.
- Enter the serial number on the nameplate into the *Endress+Hauser Operations App* or scan the 2-D matrix code (QR code) on the nameplate with the *Endress+Hauser Operations App*: all the information about the device and the technical documentation pertaining to the device is displayed.

#### 3.2.1 Nameplate

##### The right device?

Check the information on the nameplate of the device:

- Product name and manufacturer ID
- Order code, extended order code and serial number
- Power supply and power consumption
- Approvals
- Temperature range
- Firmware version and device revision

#### 3.2.2 Name and address of manufacturer

Name of manufacturer:	Endress+Hauser Wetzler GmbH + Co. KG
Address of manufacturer:	Obere Wank 1, D-87484 Nesselwang
Model/type reference:	RMA42

### 3.3 Certificates and approvals

 For certificates and approvals valid for the device: see the data on the nameplate

 Approval-related data and documents: [www.endress.com/deviceviewer](http://www.endress.com/deviceviewer) → (enter the serial number)

### 3.4 Storage and transport

Please note the following:

- Pack the device so that is protected against impact for storage and transport. The original packaging provides optimum protection.
- The permitted storage temperature is  $-40$  to  $85$  °C ( $-40$  to  $185$  °F); it is possible to store the device at borderline temperatures for a limited period (48 hours maximum).

## 4 Mounting

### 4.1 Installation requirements

#### NOTICE

**High temperatures reduce the life-time of the display.**

- ▶ To avoid heat accumulation, ensure the device is sufficiently cooled.
- ▶ Do not operate the device in the upper temperature range over a longer period of time.

The process transmitter is designed for use on the DIN rail (IEC 60715 TH35). Connections and outputs are provided on the top and underside of the device. Inputs are located on the top, while outputs and the power supply connection are located on the underside of the device. The cables are connected via labeled terminals.

Operating temperature range:

Non-Ex/Ex devices:  $-20$  to  $60$  °C ( $-4$  to  $140$  °F)

UL devices:  $-20$  to  $50$  °C ( $-4$  to  $122$  °F)

#### 4.1.1 Orientation

Vertical or horizontal.

### 4.2 Dimensions

Note the width of the device: 45 mm (1.77 in).

- Maximum depth incl. DIN rail clip 118 mm (4.65 in).
- Maximum height incl. terminals 115 mm (4.53 in).
- Housing width 45 mm (1.77 in).

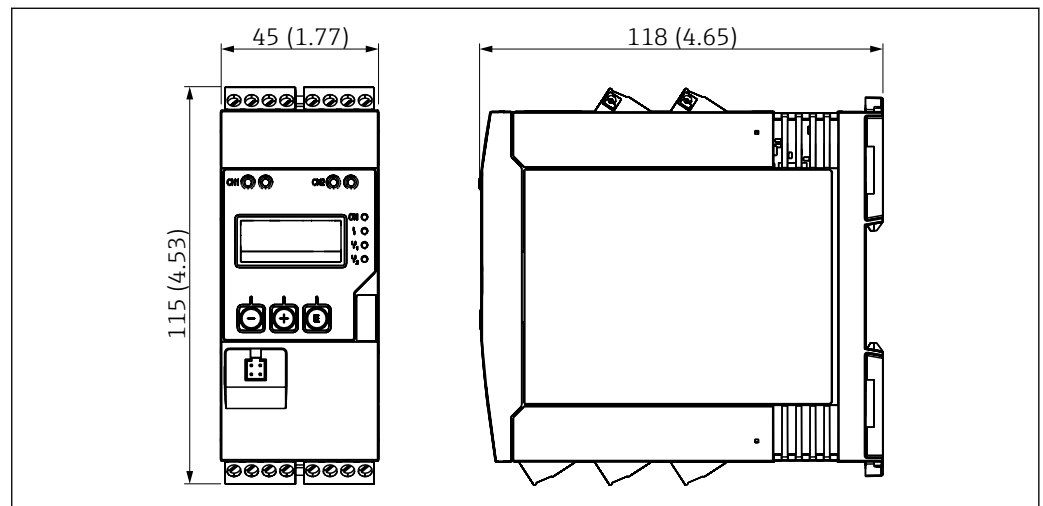

1 Dimensions of the process transmitter in mm (in)

A0011792

### 4.3 Mounting procedure

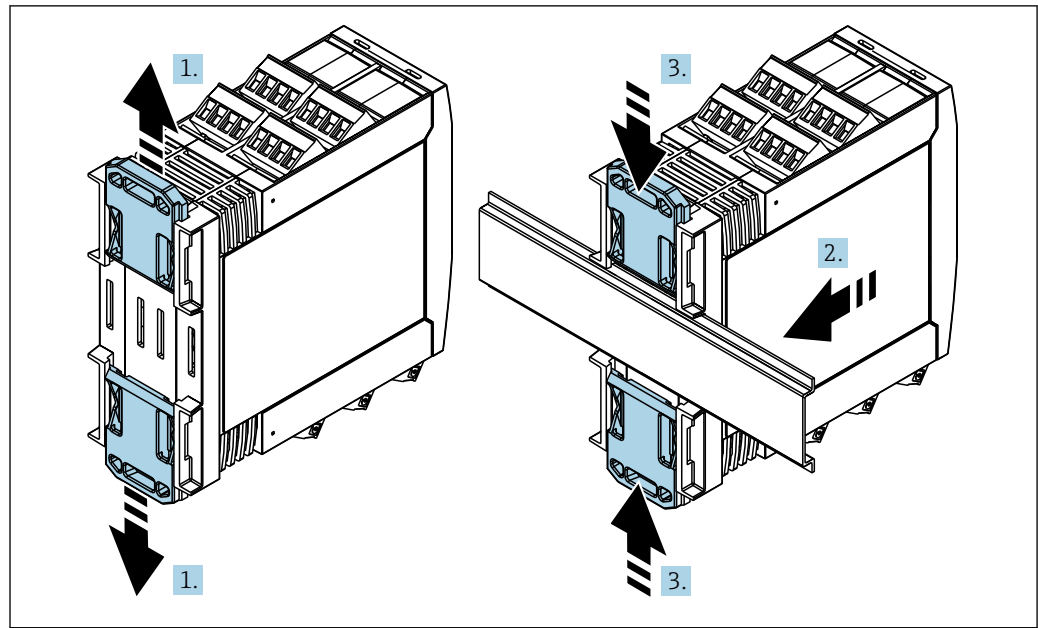

A0011766

1. Slide the upper DIN rail clip upwards and the lower clip downwards until they click into place.
2. Fit the device on the DIN rail from the front.
3. Slide the two DIN rail clips back together until they click into place.

To disassemble the device, push the DIN rail clips up or down (see 1.) and remove the device from the rail. It also suffices to open just one of the DIN rail clips and then tilt the device to remove it from the rail.

### 4.4 Post-installation check

- Is the DIN rail clip clicked into place?
- Is the device securely seated on the DIN rail?
- Are all plug-in terminals securely engaged?
- Are the temperature limits observed at the mounting location →  11?

## 5 Wiring

### **⚠ WARNING**

#### **Danger! Electric voltage!**

- ▶ The entire connection of the device must take place while the device is de-energized.
- ▶ The protective ground connection must be established before all other connections. If the protective ground is disconnected, this can be a source of danger.
- ▶ Before commissioning the device, make sure that the supply voltage matches the voltage specifications on the nameplate.
- ▶ Provide suitable switch or circuit breaker in building installation. This switch must be provided close to the device (within easy reach) and marked as a circuit breaker.
- ▶ An overcurrent protection element (rated current  $\leq 10$  A) is required for the power cable.

- i** ■ Observe the terminal designation on the side of the device.
- The mixed connection of safety extra-low voltage and dangerous contact voltage to the relay is permitted.

### 5.1 Electrical connection

A loop power supply (LPS) is provided for every input. The loop power supply is primarily designed to supply power to 2-wire sensors and is galvanically isolated from the system and the outputs.

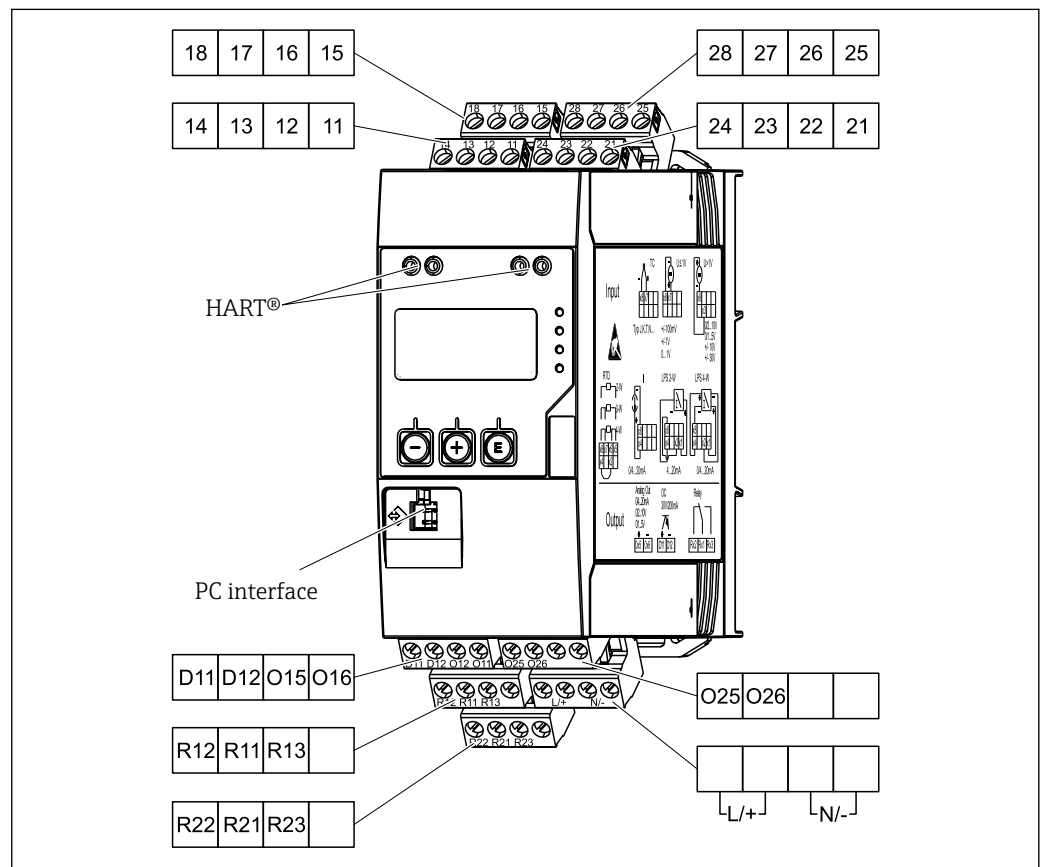

**2** Terminal assignment of process transmitter (channel 2 and relay optional)

A0011800-EN

- i** We recommend you connect a suitable surge arrester upstream if high-energy transients can be expected on long signal cables.

### 5.1.1 Overview of possible connections on the process indicator

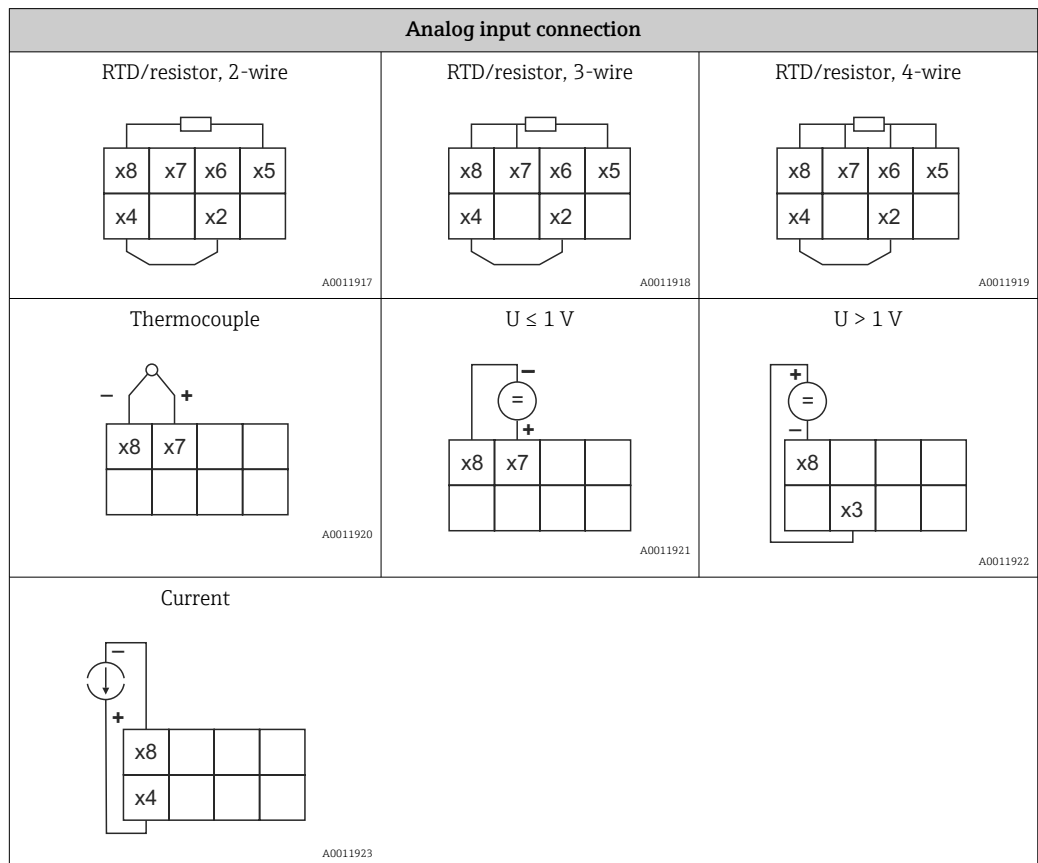
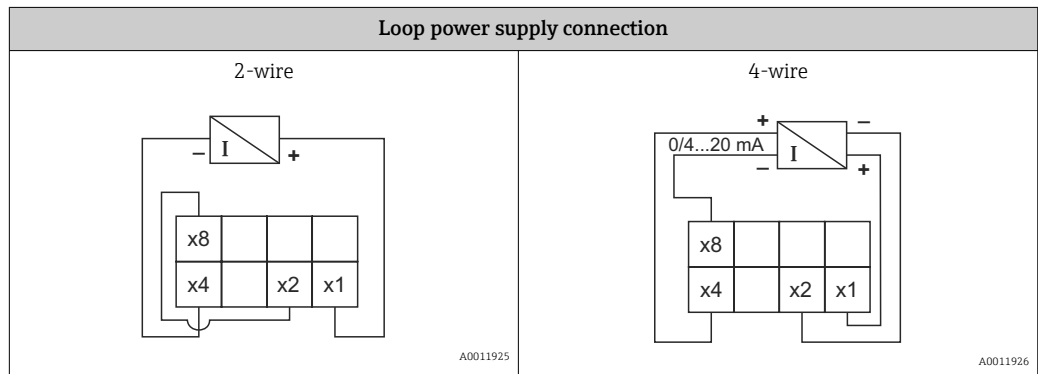
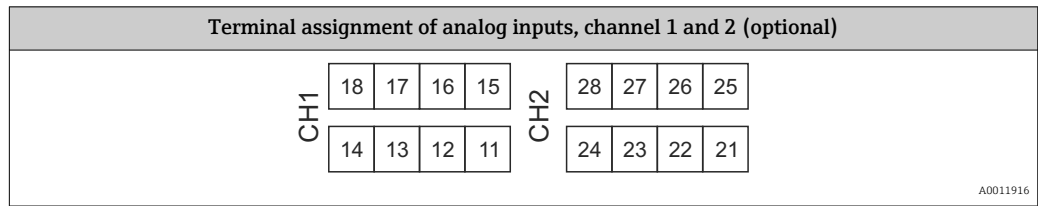

Illustrated contact position of the relays if the limit value is breached or the power supply fails:

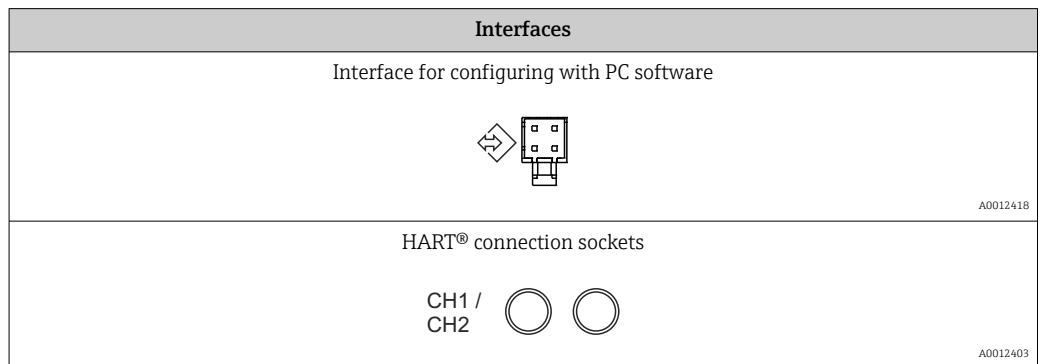
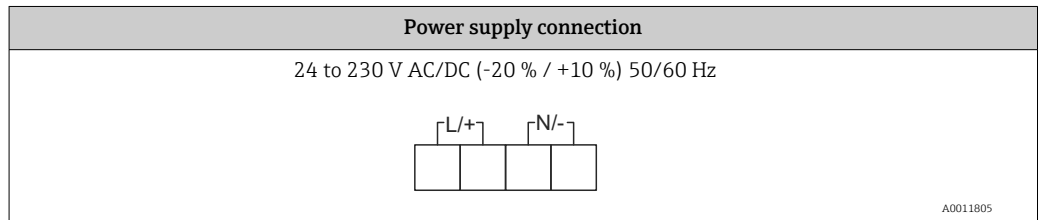
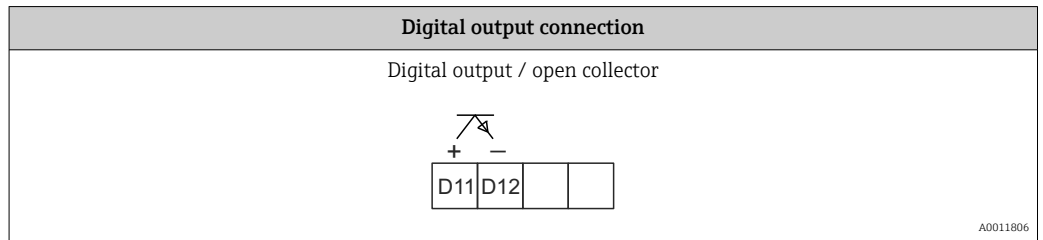
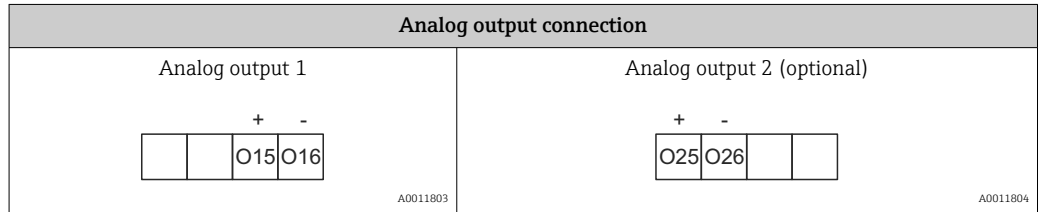
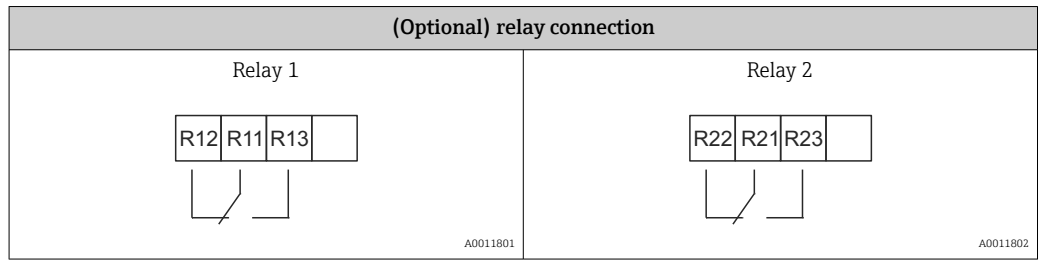

**i** The HART® terminals are connected to the internal resistor of the loop power supply. There is no internal connection to the current input. If the transmitter power supply of the device is not used, an external HART® resistor must be used in the 4 to 20 mA current loop.

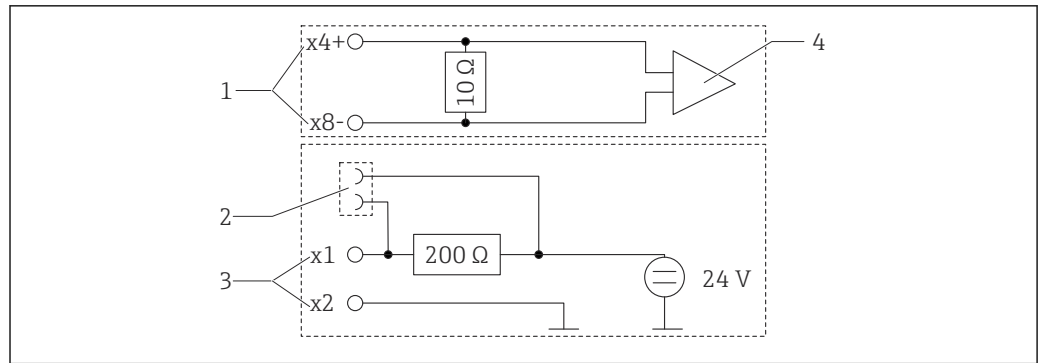

A0029250

3 Internal circuitry of the HART® connection sockets

- 1 Current input
- 2 HART® connection sockets
- 3 Transmitter power supply
- 4 A/D converter

## 5.2 Post-connection check

Device condition and specifications	Notes
Are cables or the device damaged?	Visual inspection
Electrical connection	Notes
Does the supply voltage match the specifications on the nameplate?	24 to 230 V AC/DC (-20 % / +10 %) 50/60 Hz
Are all terminals firmly engaged in their correct slot? Is the coding on the individual terminals correct?	-
Are the mounted cables strain-relieved?	-
Are the power supply and signal cables correctly connected?	See the wiring diagram on the housing.



## 6 Operation

Thanks to the device's simple operating concept, it is possible to commission the device for many applications without a printed set of Operating Instructions.



The FieldCare operating software is a quick and convenient way of configuring the device. It contains brief explanatory (help) texts that provide additional information on individual parameters.

### 6.1 Operating elements

#### 6.1.1 Local operation at the device

The device is operated by means of the three keys integrated in the front part of the device



	<ul style="list-style-type: none"> <li>▪ Open the Configuration menu</li> <li>▪ Confirm an entry</li> <li>▪ Select a parameter or submenu offered in the menu</li> </ul>
	<p>Within the Configuration menu:</p> <ul style="list-style-type: none"> <li>▪ Scroll step-by-step through the parameters/menu items/characters offered</li> <li>▪ Change the value of the selected parameter (increase or decrease)</li> </ul> <p>Outside the Configuration menu:</p> <p>Display enabled and calculated channels, as well as min. and max. values for all the active channels.</p>

You can always exit menu items / submenus by selecting "x Back" at the end of the menu.

Leave the setup directly without saving the changes by pressing the '-' and '+' keys simultaneously for longer (> 3 s).

#### 6.1.2 Configuration via interface & PC configuration software

##### CAUTION

**Undefined states and switching of outputs and relays while configuring with the configuration software**

- ▶ Do not configure the device when the process is running.

To configure the device using the FieldCare Device Setup software, connect the device to your PC. You need a special interface adapter for this purpose, e.g. the Commubox FXA291.

##### **Installing the communication DTM in FieldCare**

Before the indicator can be configured, FieldCare Device Setup must be installed on your PC. The installation instructions can be found in the FieldCare instructions.

Then install the FieldCare device driver according to the following instructions:

1. First install the device driver "CDI DTMLibrary" in FieldCare. It can be found in FieldCare under "Endress+Hauser Device DTMs → Service / Specific → CDI".
2. The DTM catalog in FieldCare must then be updated. Add the new installed DTMs to the DTM catalog.

### Installation of the Windows driver for TXU10/FXA291

Administrator rights are required to install the driver in Windows. Proceed as follows:

1. Connect the device to the PC using the TXU10/FXA291 interface adapter.
  - ↳ A new device is detected and the Windows installation wizard opens.
2. In the installation wizard, do not allow the device to automatically search for software. For this, select "No, not this time" and click "Next".
3. In the next window, select "Install software from a list or specific location" and click "Next".
4. In the next window, click "Browse" and select the directory where the driver for the TXU10/FXA291 adapter is saved.
  - ↳ The driver is installed.
5. Click "Finish" to finish the installation.
6. Another device is detected and the Windows installation wizard starts again. Again, choose "No, not this time" and click "Next".
7. In the next window, select "Install software from a list or specific location" and click "Next".
8. In the next window, click "Browse" and select the directory where the driver for the TXU10/FXA291 adapter is saved.
  - ↳ The driver is installed.
9. Click "Finish" to finish the installation.

This completes the driver installation for the interface adapter. The COM port that has been assigned can be seen in the Windows device manager.

### Establishing the connection

Proceed as follows to establish the connection with FieldCare:

1. Firstly, edit the connection macro. For this, start a new project and in the window that is displayed, right-click the symbol for "Service (CDI) FXA291" and select "Edit".
2. In the next window, to the right of "Serial interface", select the COM port which was assigned during the installation of the Windows driver for the TXU10/FXA291 adapter.
  - ↳ The macro is now configured. Select "Finish".
3. Start the "Service (CDI) FXA291" macro by double-clicking it and confirm the subsequent query with "Yes".
  - ↳ A search for a connected device is performed and the suitable DTM is opened. Online configuration is started.

Continue with device configuration in accordance with these Operating Instructions for the device. The complete Setup menu, i.e. all of the parameters listed in these Operating Instructions, can also be found in the FieldCareDevice Setup.

-  In general, it is possible to overwrite parameters with the FieldCare PC software and the appropriate device DTM even if access protection is active.

If access protection by means of a code should be extended to the software, this function should be activated in the extended device setup.

For this, select Menu → Setup / Expert → System → Overfill protect → German WHG and confirm.

## 6.2 Display and device status indicator / LED

The process indicator provides an illuminated LC display which is split into two sections. The segment section displays the value of the channel and additional information and alarms.

In the dot matrix section, additional channel information, such as the TAG, unit or bar graph, is displayed in the display mode. Operating text in English is displayed here during operation.

The parameters for configuring the display are described in detail in the "Configuring the device" section.

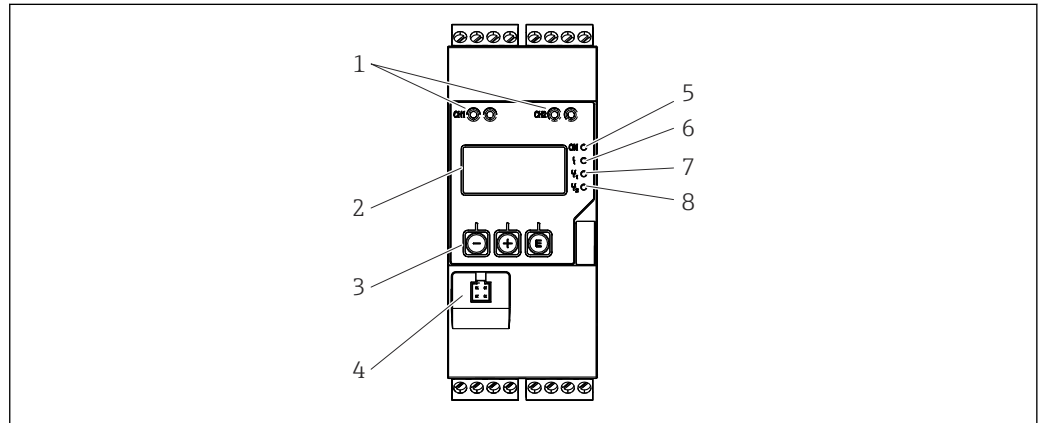

A0011767

4 Display and operating elements of the process transmitter

- 1 HART® connection sockets
- 2 Display
- 3 Operating keys
- 4 PC interface connection socket
- 5 Green LED; on = supply voltage applied
- 6 Red LED; on = error/alarm
- 7 Yellow LED; on = relay 1 energized
- 8 Yellow LED; on = relay 2 energized

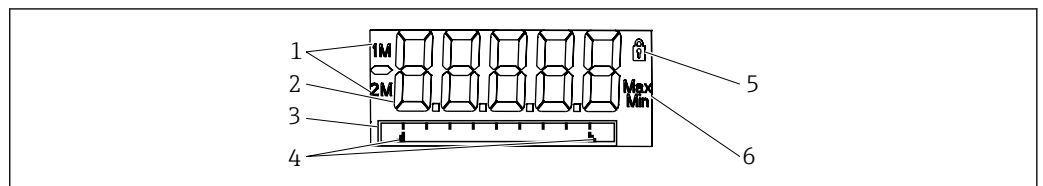

A0011765

5 Display of the process transmitter

- 1 Channel indicator: 1: analog input 1; 2: analog input 2; 1M: calculated value 1; 2M: calculated value 2
- 2 Measured value display
- 3 Dot matrix display for TAG, bar graph, unit
- 4 Limit value indicators in the bar graph
- 5 "Operation locked" indicator
- 6 Minimum/maximum value indicator

In the event of an error, the device switches automatically between displaying the error and displaying the channel, → 38 and → 41.

## 6.3 Symbols

### 6.3.1 Display symbols

	The device is locked / operator lock; the device setup is locked for changes to parameters; the display can be changed.
1	Channel one (Analog in 1)
2	Channel two (Analog in 2)
1M	First calculated value (Calc value 1)
2M	Second calculated value (Calc value 2)
Max	Maximum value/value of the maximum indicator of the channel displayed
Min	Minimum value/value of the minimum indicator of the channel displayed

#### In the event of an error:

The display shows: -----, the measured value is not displayed

Underrange/overrange: -----

 The error and the channel identifier (TAG) are specified in the dot matrix section.









### 6.3.2 Icons in the editing mode

The following characters are available for entering customized text:

'0-9', 'a-z', 'A-Z', '+', '-', '\*', '/', '\', '%', '^', '2', '3', 'm', ',', ';', ':', '!', '?', '\_', '#', '\$', '"', "'", '(', ')', '~'

For numerical entries, the numbers '0-9' and the decimal point are available.

Furthermore, the following icons are used in the editing mode:

	Symbol for setup
	Symbol for expert setup
	Symbol for diagnostics
	Accept entry. If this symbol is selected, the entry is applied at the position specified by the user, and you quit editing mode.
	Reject entry. If this symbol is selected, the entry is rejected and you quit editing mode. The previously set text remains.
	Jump one position to the left. If this symbol is selected, the cursor jumps one position to the left.
	Delete backwards. If this symbol is selected, the character to the left of the cursor position is deleted.
	Delete all. If this symbol is selected, the entire entry is deleted.

## 6.4 Quick guide to the operating matrix

The following tables list all the menus and the operating functions.

Display menu		Description
Ⓔ	AI1 Reset minmax*	Reset the min/max values for Analog in 1
⊕	AI2 Reset minmax*	Reset the min/max values for Analog in 2
⊕	CV1 Reset minmax*	Reset the min/max values for Calc value 1
⊕	CV2 Reset minmax*	Reset the min/max values for Calc value 2
⊕	Analog in 1	Display setting for analog input 1
⊕	Analog in 2	Display setting for analog input 2
⊕	Calc value 1	Display setting for calculated value 1
⊕	Calc value 2	Display setting for calculated value 2
⊕	Contrast	Display contrast
⊕	Brightness	Display brightness
⊕	Alternating time	Switchover time between values chosen to be displayed
⊕	Back	Return to the main menu

\*) Is only displayed if "Allow reset" = "Yes" is set in the "Expert" menu for the corresponding channel.

Setup menu		Description
Ⓔ	Application	Application selection
	1-channel	1-channel application
	2-channel	2-channel application
	Diff-pressure	Differential pressure application
⊕	AI1 Lower range*	Lower measuring range limit for Analog in 1
⊕	AI1 Upper range*	Upper measuring range limit for Analog in 1
⊕	AI2 Lower range*	Lower measuring range limit for Analog in 2
⊕	AI2 Upper range*	Upper measuring range limit for Analog in 2
⊕	CV Factor*	Factor for calculated value
⊕	CV Unit*	Unit for calculated value
⊕	CV Bar 0%*	Bar graph lower limit for calculated value
⊕	CV Bar 100%*	Bar graph upper limit for calculated value
⊕	Linearization*	Linearization for calculated value
	No lin points	Number of linearization points
	X-value	X-values for linearization points
	Y-value	Y-values for linearization points
⊕	Analog in 1	Analog input 1
	Signal type	Signal type
	Signal range	Signal range
	Connection	Connection type (only for Signal type = RTD)
	Lower range	Measuring range lower limit
	Upper range	Measuring range upper limit
	Tag	Designation of analog input
	Unit	Unit for analog input

\*) Is only displayed if "Application" = "Diff pressure".

Setup menu		Description
	Temperature unit	Unit of temperature, only visible if "Signal type" = RTD or TC
	Offset	Offset for analog input
	Ref junction	Reference junction (only for Signal type = TC)
	Reset min/max	Reset min/max values for analog input
⊕	Analog in 2	Analog input 2
	See Analog in 1	
⊕	Calc value 1	Calculated value 1
	Calculation	Type of calculation
	Tag	Designation of calculated value
	Unit	Unit for calculated value
	Bar 0%	Bar graph lower limit for calculated value
	Bar 100%	Bar graph upper limit for calculated value
	Factor	Factor for calculated value
	Offset	Offset for calculated value
	No lin points	Number of points for linearization
	X-value	X-values for linearization points
	Y-value	Y-values for linearization points
	Reset min/max	Reset min/max values
	Calc value 2	Calculated value 2
	See Calc value 1	
⊕	Analog out 1	Analog output 1
	Assignment	Analog output assignment
	Signal type	Signal type, analog output
	Lower range	Lower range limit of analog output
	Upper range	Upper range limit of analog output
⊕	Analog out 2	Analog output 2
	See Analog out 1	
⊕	Relay 1	Relay 1
	Assignment	Assignment of value to be monitored with relay
	Function	Operating mode of the relay
	Set point	Limit value for relay
	Set point 1/2	Limit values 1 and 2 for relay (only if Function = Inband, Outband)
	Time base	Time base for gradient evaluation (only if Function = Gradient)
	Hysteresis	Hysteresis for relay
⊕	Relay 2	Relay 2
	See Relay 1	
⊕	Back	Return to the main menu

\*) Is only displayed if "Application" = "Diff pressure".

Diagnostics menu		Description
Ⓔ	Current diagn	Current diagnostic message
⊕	Last diagn	Last diagnostic message
⊕	Operating time	Operating time of the device
⊕	Diagnost logbook	Diagnostics logbook
⊕	Device information	Device information
⊕	Back	Return to the main menu

Expert menu		Description
Ⓔ	Direct access	Direct access to an operating item
⊕	System	System settings
	Access code	Protection of operation by an access code
	Overfill protect	Overfill protection
	Reset	Device reset
	Save user setup	Save setup settings
⊕	Input	Inputs
	The following parameters are available in addition to the parameters from the Setup menu:	
	Analog in 1 / 2	Analog input 1 / 2
	Bar 0%	Lower limit for bar graph of analog input
	Bar 100%	Upper limit for bar graph of analog input
	Decimal places	Decimal places for analog input
	Damping	Damping
	Failure mode	Failure mode
	Fixed fail value	Fixed value in the event of an error (only if Failure mode = Fixed value)
	Namur NE43	Error limits according to Namur
	Allow reset	Reset the min/max values via the Display menu
⊕	Output	Outputs
	The following parameters are available in addition to the parameters from the Setup menu:	
	Analog out 1 / 2	Analog output 1 / 2
	Fail mode	Failure mode
	Fixed fail value	Fixed value in the event of an error (only if Fail mode = Fixed value)
	Relay 1 / 2	Relay 1/2
	Time delay	Switching delay
	Operating mode	Operating mode
	Failure mode	Behavior in the event of an error

## 7 Commissioning

### 7.1 Post-installation check and switching on the device

Make sure that all post-connection checks have been carried out before putting your device into operation:

- Checklist for "post-installation check" →  12
- Checklist for "post-connection check" →  16

After the operating voltage is applied, the green LED lights up and the display indicates the device is ready for operation.

If you are commissioning the device for the first time, program the setup as described in the following sections of the Operating Instructions.

If you are commissioning a device that is already configured or preset, the device starts measuring immediately as defined in the settings. The values of the channels currently activated are shown on the display. Changes to the display can be made in the Display menu item →  34.

 Remove the protective film from the display as this would otherwise affect the readability of the display.

### 7.2 General information about configuring the device

You can configure your device onsite or put it into operation using the three integrated keys or via the PC. You require the Commubox FXA291/TXU10 (see the 'Accessories' section) to connect the device to a PC.

Advantages of configuring via FieldCare Device Setup:

- The device data are saved in FieldCare Device Setup and can be retrieved at any time.
- Data entry is faster with the keyboard.

### 7.3 Notes on setup access protection

Access to the setup is enabled by default (factory setting) and can be locked via the setup settings.

Proceed as follows to lock the device:

1. Press **E** to enter the configuration menu.
2. Press **+**, **Setup** is displayed.
3. Press **E** to open the **Setup** menu.
4. Repeatedly press **+** until **System** is displayed.
5. Press **E** to open the **System** menu.
6. **Access code** is displayed.
7. Press **E** to open the setting for access protection.
8. Set the code: press the **+** and **-** buttons to set the desired code. The access code is a four-digit number. The corresponding position of the number is displayed in plain text. Press **E** to confirm the value entered and go to the next position.











9. Confirm the last position of the code in order to exit the menu. The full code is displayed. Press **+** to scroll back to the last item of the **x Back** submenu and confirm this item. By confirming the point, the value is adopted and the display returns to the **Setup** level. Again select the last parameter **x Back** to also exit this submenu and return to the measured value/channel display level.

 The **x Back** item at the end of every picklist/menu item takes the user from the submenu to the next menu level up.

## 7.4 Device configuration

Configuration steps:

1. Selection of the application conditions (only for 2-channel device) →  25
2. Configuration of the universal input/inputs →  27
3. Configuration of calculations →  28
4. Configuration of the analog output/outputs →  29
5. Configuration of the relays (if option selected); assignment and monitoring of limit values →  29
6. Advanced device configuration (access protection/operating code; backup of current setup/user setup) →  33
7. Configuration of display functionalities →  34

The following section describes in detail how to set up the two-channel device and the differential pressure application package (brief overview of the configuration →  26, only available in the two-channel version). If you want to configure a single-channel device, please proceed as described in Step 2. →  27.

### 7.4.1 Step 1: Selecting the application conditions/number of active input channels

#### Application conditions for two-channel device

Call up the Setup menu after performing the post-installation check.

Press **E** → press **+** → **Setup** is displayed → press **E**.

Select your application conditions in the first item of the setup. You have a choice of the following settings:

- Differential pressure (Diff pressure): application package; parameters are automatically preselected for you.
- One-channel (1-channel): universal input 2 (Analog in 2) is deactivated (off) in the software. The second channel can be enabled any time via **Setup** → **Analog in 2** →  27.
- Two-channel (2-channel): universal input 1 (Analog in 1) and universal input 2 (Analog in 2) are pre-configured with the following values:
  - Signal type: **Current**
  - Signal range: **4-20mA**

A full description of the "Differential pressure" application package is provided in the following section.

To set up the device in single-channel/two-channel applications, please proceed with the device setup as explained in Step 2 →  27.

 If the application or the selected parameter are subsequently changed, parameters already configured are retained (e.g. if the differential pressure application is changed to two-channel, **Calc value 1** remains set to Difference).

### Differential pressure application

A concise setup is available for differential pressure applications.

Once the differential pressure application setup has been completed successfully, the difference between the two inputs is automatically calculated and the signal linearized using the configured parameters of the analog inputs and the linearization points. As a result, the volume is already shown on the display (= calculated value 2).

- i** Prerequisites for correct value calculation and a functioning setup:
- Sensor 1 returns the higher pressure: connected to analog input 1 (Analog in 1)
  - Sensor 2 returns the lower pressure: connected to analog input 2 (Analog in 2)

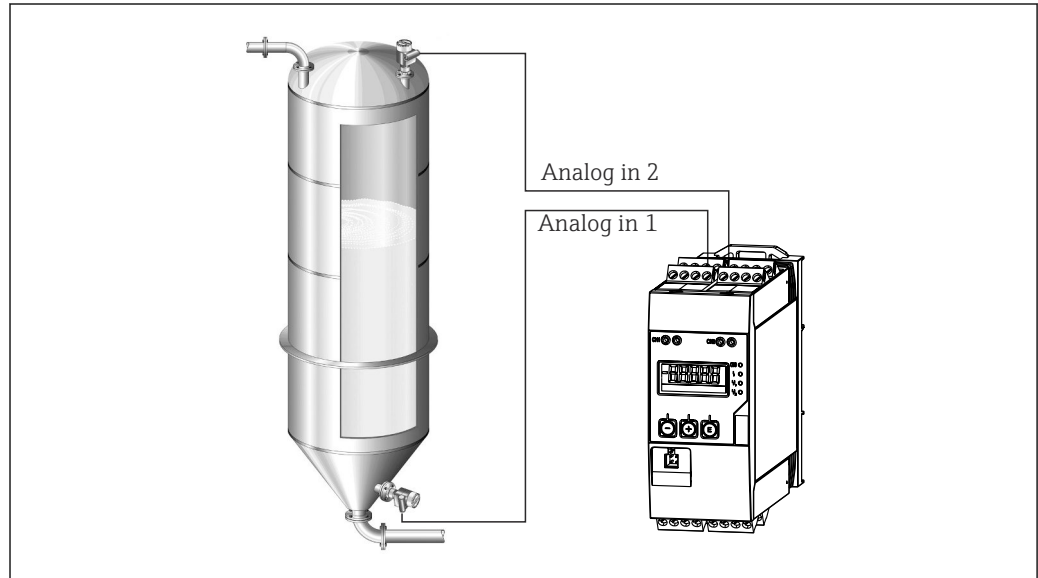

A0011762

**6** Differential pressure application

### Setup → Application → Diff pressure

Once the differential pressure application has been selected by confirming the **Diff pressure** parameter, the editable parameters are displayed in succession and must be configured individually for your application.

Some parameters are already configured for you due to the selection of the application setup → **27**.





The **CV Factor** parameter is used to take the density of the medium into account during level measurement, i.e. it corresponds to the mathematic formula  $1/(\text{density} \cdot \text{gravitational acceleration})$ . The default value for the factor is 1.

The density must be given in  $\text{kg/m}^3$  and the pressure in Pascal (Pa) or  $\text{N/m}^2$ . The gravitational acceleration is defined by the constant on the earth's surface.

This is  $g=9.81 \text{ m/s}^2$ . Tables and examples for converting application-related units into the defined values  $\text{kg/m}^3$  and Pa or  $\text{N/m}^2$  can be found in the Appendix → **56**.



- i** Other parameters can be enabled in the setup for the corresponding parameter (see Steps 4, 5, 6 and 7 or offset for analog inputs, display original values of analog channels, etc.).

### 'Setup' menu item

Setup → Application → 'Diff pressure'	
Preconfigured by application package	Submenu
Setup analog inputs Signal: <b>Current</b> Range: <b>4-20 mA</b> →  25 and →  27	<b>AI1 Lower range:</b> start of measuring range, analog input 1 (corresponds to 4 mA for example)
	<b>AI1 Upper range:</b> end of measuring range, analog input 1 (corresponds to 20 mA for example)
	<b>AI2 Lower range:</b> start of measuring range, analog input 2 (corresponds to 4 mA for example)
	<b>AI2 Upper range:</b> end of measuring range, analog input 2 (corresponds to 20 mA for example)
Setup display Display: calculated value and bar graph for <b>Calc Value 2:</b> Active; all other values inactive →  34	<b>CV Unit:</b> unit of the calculated volume value (e.g.liters)
	<b>CV Bar 0%:</b> start of measuring range for bar graph display
	<b>CV Bar 100%:</b> end of measuring range for bar graph display
<b>CV Factor</b>	<b>CV Factor:</b> factor to take the density of the medium into account during level measurement, i.e. it corresponds to the mathematic formula $1/(\text{density} \cdot \text{gravitational acceleration})$ ; default value: 1
Setup calculation of the volume: Calc value 1: <b>Difference</b> Calc value 2: <b>Lineariz. CV1</b> →  28	Create the linearization table: If the volume value should be calculated - i.e. a linearization of the difference is output - the X and Y coordinates must be specified as the basis for performing the calculation.
	<b>No lin points:</b> number of linearization points required (max. 32)
	<b>X-value:</b> X-coordinate for linearization point X1, 2, etc.
	<b>X-value:</b> Y-coordinate for linearization point X1, 2, etc.
	End differential pressure setup

### 7.4.2 Step 2: Configuring the universal input(s) (Analog in 1/2)

The device has one universal input, and optionally an additional universal input for current, voltage, resistance thermometers (RTD) or thermocouples (TC).

The input is monitored for a cable open circuit (see the 'Measuring range limits' table →  38 and the 'Troubleshooting' section →  41).

#### Minimum/maximum values at the inputs:

 The current min./max. value is saved every 15 minutes. If the power supply is disconnected (power off/power on), there may be a gap in the recording sequence. The measuring interval starts when the device is switched on. It is not possible to synchronize the measuring cycles to full hours.

Limit values and relays are available for monitoring the measured values. They must be configured as described in Step 5 →  29.

Each universal input saves the smallest and largest measured value that is measured. These values can be reset individually for every channel. In the setup, the administrator can specify that a user can reset the minimum and maximum values of the individual channels directly in the main menu without the need for a release code. The min./max. value is reset if a reset is performed and if channel scaling is changed.

Setup
Analog in 1 Analog in 2

<b>Current</b>	<b>Voltage</b>	<b>RTD</b> (resistance temperature detector)	<b>TC</b> (thermocouple)	<b>Off</b> (deactivate the input)
<b>Signal range</b> Signal range (see Technical data); start and end of measuring range defined by the type selected				
<b>Lower range</b> Start of measuring range; also enter the decimal point		<b>Connection</b> (RTD only) Type of connection (2-, 3-, 4-wire connection)		
<b>Upper range</b> End of measuring range; also enter the decimal point				
<b>TAG</b> Channel identifier				
<b>Unit</b> Unit				
<b>Offset</b> Constant value that is added to the current measured value				
			<b>Ref junction</b> (TC only) Internal/fixed + entry of "Fixed ref junc"	
<b>Res minmax:</b> (yes/no) Reset minimum/maximum values?				

### 7.4.3 Step 3: Configuring the calculations

One channel or two channels (optional) with the following functions are available for calculations:

Setup	
Calc value 1	Calc value 2
<ul style="list-style-type: none"> <li>▪ Switched off</li> <li>▪ Sum (AI1+AI2)</li> <li>▪ Difference (AI1-AI2)</li> <li>▪ Average ( (AI1+AI2)/2 )</li> <li>▪ Linearization AI1</li> <li>▪ Multiplication (AI1*AI2)</li> </ul>	<ul style="list-style-type: none"> <li>▪ Switched off</li> <li>▪ Sum (AI1+AI2)</li> <li>▪ Difference (AI1-AI2)</li> <li>▪ Average ( (AI1+AI2)/2 )</li> <li>▪ Linearization AI2</li> <li>▪ Linearization CV1</li> <li>▪ Multiplication (AI1*AI2)</li> </ul>
<b>TAG</b> <b>Unit</b> <b>Bar 0%</b> <b>Bar 100%</b> <b>Factor</b> <b>Offset</b>	To be configured like the universal input, see Step 2 → 27
<b>No. lin points</b> → X/Y coordinates The device has two linearization tables, each with a maximum of 32 linearization points. They are permanently assigned to the 'Calc value 1' and 'Calc value 2' channels. If linearization is selected as the calculation, the number of linearization points needed is specified in the 'No. lin points' parameter. An X-coordinate and a Y-coordinate must be specified for each linearization point. The linearization tables can be deactivated individually.	
<b>Reset min/max</b>	To be configured like the universal input, see Step 2 → 27

### 7.4.4 Step 4: Configuring the analog output(s)

The device has one analog output (optionally two analog outputs). These outputs can be freely assigned to the inputs and channels available in the device.

Setup	
Analog out 1 Analog out 2	
<b>Assignment:</b> assignment of the output <ul style="list-style-type: none"> <li>▪ <b>Off:</b> switched off</li> <li>▪ <b>Analog input 1:</b> universal input 1</li> <li>▪ <b>Analog input 2:</b> universal input 2</li> <li>▪ <b>Calc value 1:</b> calculated value 1</li> <li>▪ <b>Calc value 2:</b> calculated value 2</li> </ul>	
<b>Signal type:</b> select active signal range of the output	The output range for the current output corresponds to Namur NE43, i.e. a range to 3.8 mA or 20.5 mA is used. If the value continues to increase (or continues to drop), the current remains at the limits 3.8 mA or 20.5 mA. 0-20 mA output: only the overrange is available. An overrange is also only available for the voltage output. The limit of the overrange is 10% here.
<b>Lower range</b> <b>Upper range</b>	To be configured like the universal input, see Step 2 →  27

### 7.4.5 Step 5: Configuring the relays, assigning and monitoring limit values

As an option, the device has two relays with limit values, which are either switched off, or can be assigned to the input signal or the linearized value of analog input 1 or 2 or the calculated values. The limit value is entered as a numerical value including the decimal position. Limit values are always assigned to a relay. Each relay can be assigned to a channel or a calculated value. In the "Error" mode, the relay functions as an alarm relay and switches each time a fault or alarm occurs.

The following settings can be made for each of the two limit values: assignment, function, set point, hysteresis, switching behavior <sup>1)</sup>, delay <sup>1)</sup> and failure mode <sup>1)</sup>.

Setup	
Relay 1 Relay 2	
<b>Assignment:</b> Which value should be monitored?	<b>Off</b> , Analog input 1, Analog input 2, Calc value 1, Calc value 2, Error
<b>Function:</b> Operating mode of the relay (for a description, see the "Operating modes" →  30)	Min, Max, Gradient, Out-band, In-band
<b>Set point:</b> <b>Set point 2:</b> Limit value	Enter the limit value with the position of the decimal point. Set point 2 is only displayed for out-band and in-band.

1) Can only be set via the Expert menu, Expert/Output/Relay

<b>Time base:</b> Time base for calculating the gradient	Enter the time base in seconds. Only for the Gradient operating mode.
<b>Hysteresis:</b> Hysteresis. For every set point, the switch point can be controlled via a hysteresis.	The hysteresis is configured as an absolute value (only positive values) in the unit of the particular channel (e.g. upper limit value = 100 m, hysteresis = 1 m: limit value on = 100 m, limit value off = 99 m)

- i** Please note special situations where both the hysteresis and the delay time should be activated simultaneously (see the following description in the "Operating modes" section).
- Following a power failure, the limit value monitoring system behaves as if the limit value had not been active before the power failure, i.e. the hysteresis and any delay are reset.

**Relay specification**

Relay contact	Changeover
Maximum contact load DC	30 V / 3 A (permanent state, without destroying the input)
Maximum contact load AC	250 V / 3 A (permanent state, without destroying the input)
Minimum contact load	500 mW (12 V / 10 mA)
Galv. isolation towards all other circuits	Test voltage 1 500 V <sub>AC</sub>
Switching cycles	> 1 million
Default setting	Normally closed: NC contact Rx1/Rx2

**Operating modes**

*Off*

No action is triggered. The assigned output is always in the normal operating state.

*Min (lower limit value)*

The limit is active if the value drops below the configured value. The limit value is switched off if the limit value, including hysteresis, is exceeded.

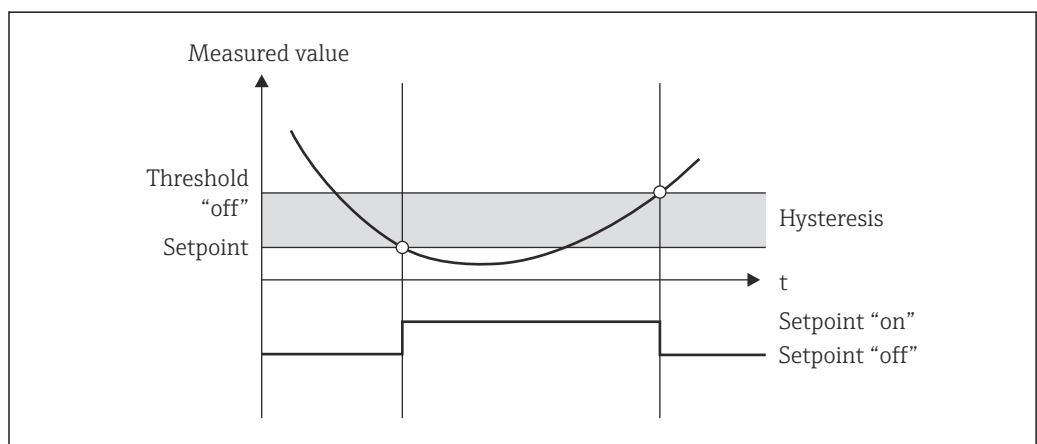

**7** *Min operating mode*

*Max (upper limit value)*

The limit value is active if the value exceeds the configured value. The limit value is switched off if the limit value, including hysteresis, is undershot.

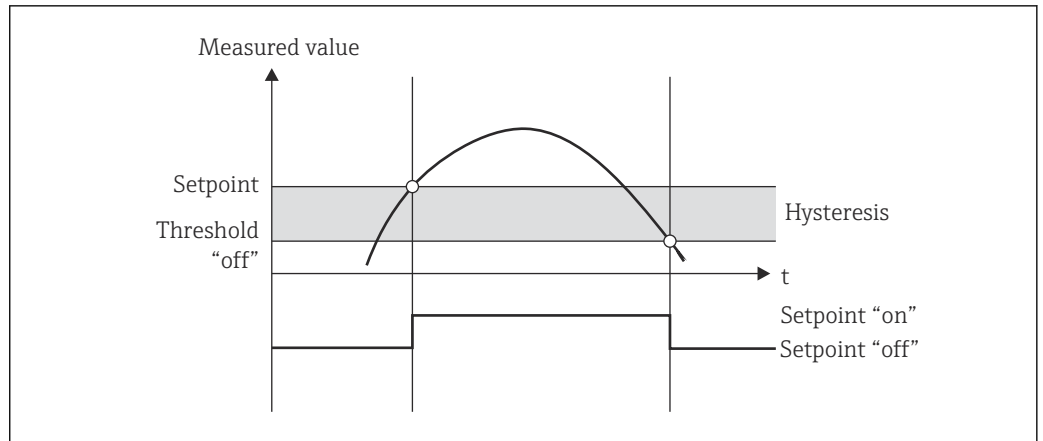

A0048461

8 Max operating mode

*Gradient*

The "Gradient" operating mode is used to monitor the change of the input signal over time. The alarm is triggered if the measured value reaches or exceeds the preset value. If the user configures a positive value, the limit value is monitored for increasing gradients.

In the case of negative values the decreasing gradient is monitored.

The alarm is canceled when the gradient drops below the preset value. A hysteresis is not possible in the Gradient operating mode. The alarm can be suppressed for the set time delay (unit: seconds s) in order to decrease the sensitivity.

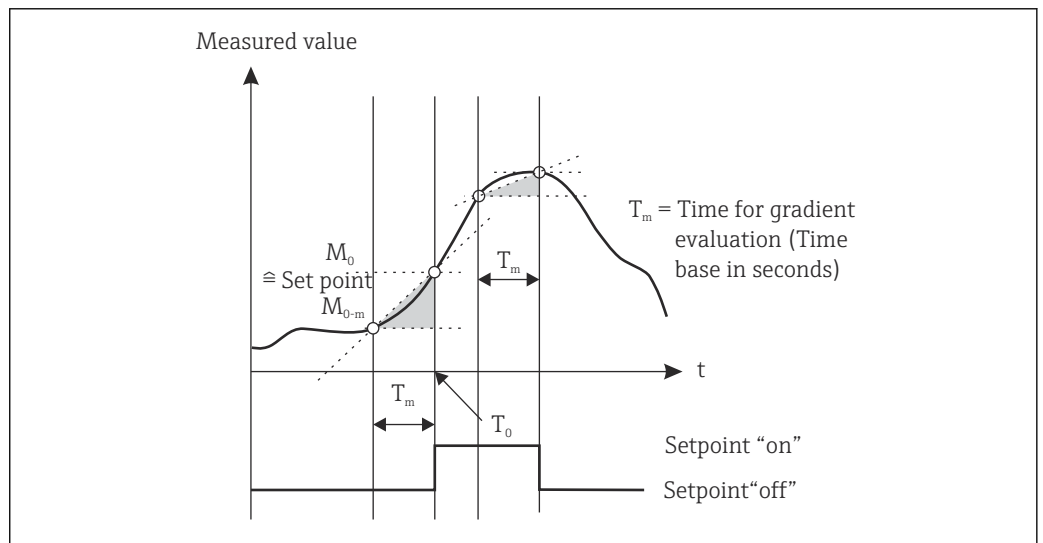

A0048462

9 Gradient operating mode

*OutBand*

The limit value is violated as soon as the measured value to be checked lies within a preset band between minimum and maximum. The hysteresis must be monitored on the outside of the band.

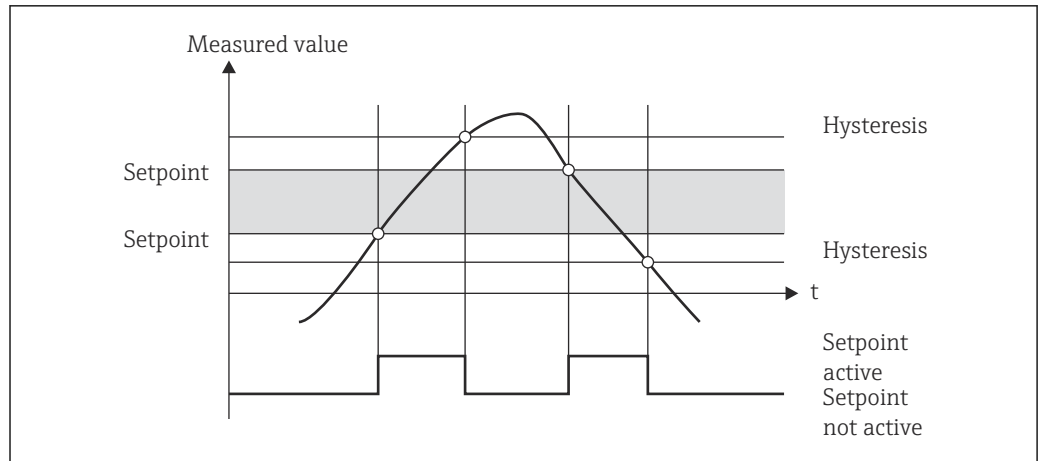

10 OutBand operating mode

### InBand

The limit value is violated as soon as the measured value to be checked exceeds or drops below a preset maximum or minimum respectively. The hysteresis must be monitored on the inside of the band.

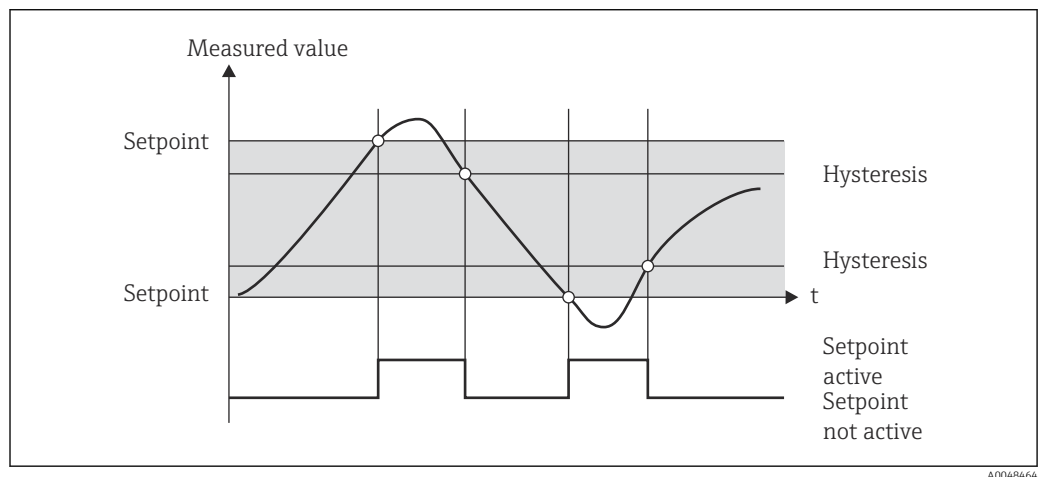

11 InBand operating mode

### Special case: Hysteresis and delay for one limit value

In the special scenario where the hysteresis and limit value delay are activated, a limit value is switched according to the following principle.

If the hysteresis and the limit value delay are activated, the delay becomes active when a limit value is exceeded and measures the time since the start of limit value overshoot. If the measured value falls below the limit value, the delay is reset. This also occurs if the measured value falls below the limit value, but continues to be higher than the set hysteresis value. When the limit value is exceeded again, the delay time becomes active again and starts measuring from 0.



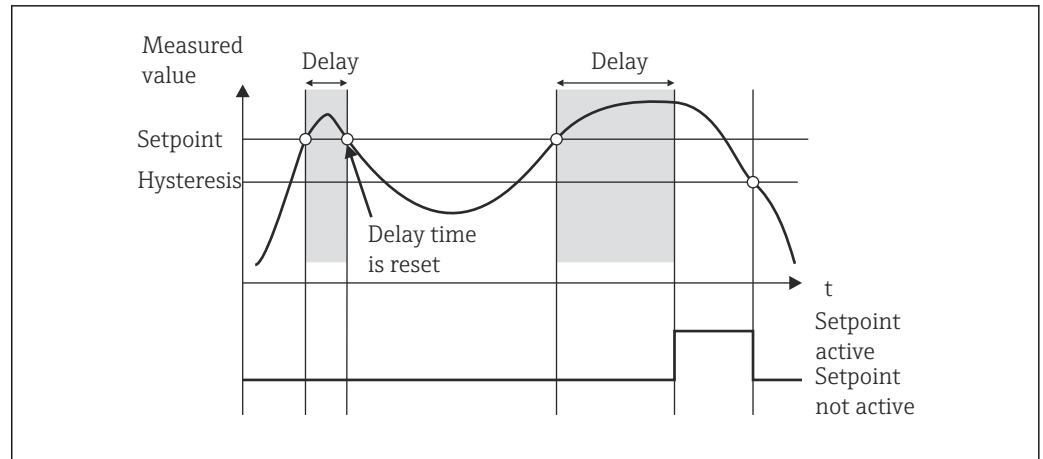

12 Hysteresis and delay active

### 7.4.6 Step 6: Advanced device configuration (access protection/operating code, saving the current setup)

#### Access protection

Access protection locks all the editable parameters, i.e. the setup can only be accessed once the 4-digit user code has been entered.

Access protection is not activated at the factory. However, the configuration of the device can be protected by a four-digit code.

Activating access protection

1. Call the menu 'Setup' → 'System' → 'Access code'
2. To enter the code with the '+' and '-' keys, select the desired character and press 'E' to confirm. The cursor goes to the next position.
  - ↳ After confirming the fourth position, the entry is accepted and the user exits the 'Access code' submenu.

Once access protection has been successfully activated, the lock symbol appears on the display.

- i** If access protection is enabled, the device locks automatically after 600 seconds if the device has not been operated during this time. The display switches back to the operating display. To delete the code completely, use the '+' and '-' keys to select the "c" character and press 'E' to confirm.

#### Saving the current setup/user setup

The current device configuration can be saved and is therefore available as a specific setup for a device reset or for a device restart. If you ordered the device with customized settings, the preconfigured setup is also saved in the user setup.

Saving the setup

1. Call the menu 'Expert' → 'System' → 'Save User Setup'.
2. Confirm by selecting 'yes'.

- i** See also "Device reset" → 39.

### 7.4.7 Step 7: Configuring the display functions

The display is split into a 7-segment display section and a color section. The dot matrix section can be configured separately for each channel.

Users can choose from all the active channels (analog inputs and calculated values).

Configuration of the display

1. Press 'E'
2. Select 'Display'.
3. Select channel/calculated value and configure one of the parameters that follow.

<b>Off</b>	Channel is not displayed.	
Activate the display by configuring the color section		
	Value/measured value of the channel is displayed on the 7-segment display.	
	<b>Unit</b>	The unit of the channel is displayed
	<b>Bar graph</b>	The value of the channel is displayed as a bar graph over the entire width.
	<b>Bargr+unit</b>	Division of the color section, displays value of the channel as a bar graph and unit of the channel
	<b>TAG+unit</b>	Division of the color section, displays channel name and unit of the channel

- **Contrast:** select contrast (can be configured in steps of 1 to 7)
- **Brightness:** select brightness (can be configured in steps of 1 to 7)
- **Alternating time:** select the time between automatic switchover between the channels and calculated values (in seconds: 3, 5, or 10)
- **x Back** takes you back to the menu one level up.

 If several channels are active, the device switches automatically between the channels configured.

Non-activated channels, calculated values and minimum and maximum values are called up manually by pressing the '+' and '-' keys and appear for 5 seconds on the display.

### 7.4.8 Overfill protection

The German Water Resources Act (WHG) requires the use of overfill protection units on vessels for water-polluting liquids. These units monitor the level and trigger an alarm in time before the permitted fill level is reached. According to the approval guidelines for overfill protection units (ZG-ÜS), suitable plant units must be used for this.

In accordance with these guidelines, the device can be used as a limit signal transmitter for overfill protection units with continuous level measurement for storing liquids which are hazardous to water (water-polluting liquids).

As a prerequisite the device must comply with the general and special construction principles (chapters 3 and 4) of the approval guidelines for overfill protection units. This means that the safety-oriented message "Maximum level" is displayed (the limit relay de-energizes) in the following situations:

- in the event of power supply failure and
- if limit values are exceeded or undershot and
- if the connection cables between the upstream transmitter and the limit signal transmitter are disconnected.

In addition, the configured limit values for overflow protection must be secured against unintentional modification.



The following function must be activated if additional access protection should be provided for the configuration software:

Select **Setup / Expert** → **System** → **Overflow protect: German WHG**

#### **Configuration when operating the device in accordance with the approval guidelines for overflow protection units:**

The device must be set up and operated in accordance with these Operating Instructions pertaining to the device.

- Universal inputs must be configured (like in Step 1 - Step 3 → 25).
- Limit values must be configured as follows (like Step 5 → 29):

**Function:** MAX

**Assignment:** which input signal should be monitored?

**Set point:** maximum limit value to be monitored; value for the switching threshold

**Hysteresis:** no hysteresis (=0)

**Time delay**<sup>1)</sup>: no switching delay (=0) or the set time must be taken into account for the tail quantity

- The device must be locked for unauthorized persons;

**User Code** protects the configured parameters (like Step 6 → 33):

Enter the 4-digit code: select digit with '+' or '-' and press 'E' to confirm the individual digit; once the digit has been confirmed, the cursor moves to the next position, or skips back to the 'System' menu item once the fourth digit has been entered

The lock symbol appears on the display.

- Select **Setup** → **System** → **Overflow protect: German WHG**.

It is absolutely essential to assign the device to a WHG application. Confirming the 'Overflow protect: German WHG' parameter provides additional safety. The device status must be changed if the device is being configured using the FieldCare operating software, i.e. WHG must be disabled to be able to change parameters.

1) Can only be configured in the "Expert" menu

## 7.4.9 Expert menu

You activate the Expert mode by pressing **E** → **Expert**.

The Expert menu offers advanced device settings to adapt the device optimally to the application conditions.

Access to the Expert menu requires an access code. The factory default code is "0000". If a new access code is defined by the user, it replaces the access code assigned at the factory.

The Expert menu is enabled as soon as the correct access code has been entered.

The configuration options which the Expert mode also offers in addition to the normal setup parameters are described in the following section.

### **Input** → **Analog input 1/2**

*Bar 0%, Bar 100%*

Change the scaling of the bar graph; default value: channel scaling

*Decimal places*

Specify the desired number of decimal places; default value: 2 decimal places

*Damping*

The input signal can be dampened by a low-pass filter.

The damping is specified in seconds (can be configured in steps of 0.1 s , max. 999.9 s).

#### Default values

Input type	Default value
Current and voltage inputs	0.0 s
Temperature inputs	1.0 s

Once 5 times the filter time has elapsed, 99% of the actual measured value is reached.

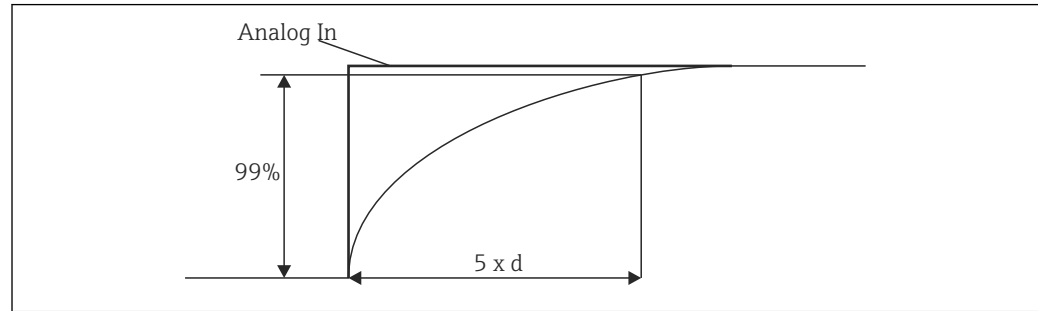

A0010508

#### 13 Signal damping

Analog In: Analog input signal

d: Set damping

#### Failure mode

If an error is detected at one of the two inputs, the internal status of the input is set to error. The behavior of the measured value in the event of an error can be defined here.

- Invalid = invalid value:  
The value is not calculated further as it is passed on as an invalid value.
- Fixed value = constant value:  
A constant value can be entered. This value is used if the device should perform further calculations. The input continues to be in the "error" state.

#### Namur NE43

Only for 4 to 20 mA. The measured value and the cables are monitored in accordance with NAMUR NE43 recommendations. See → 38. Default value: enabled

#### Open circ detect

Only for 1 to 5 V. Input monitored for cable open circuit.

#### Failure delay

Delay time for failures, 0 to 99 s

#### Allow reset

If this function is activated, the min. and/or max. values can be reset outside the setup in the Display menu. Active access protection does not apply when this memory is reset.

### Output → Analog output 1/2

#### Failure mode

- Min = stored minimum value:  
The stored minimum value is output.
- Max = stored maximum value:  
The stored maximum value is output.
- Fixed value = constant value:  
It is possible to enter a constant value that is output in the event of an error.

**Output → Relay 1/2***Time delay*

Sets the time delay for switching the relay

*Operating mode*

Operating mode of the relay.

- norm opened
- norm closed

*Failure mode*

- norm opened
- norm closed

**NOTICE****Setting the limit relay failure mode**

- ▶ The failure mode of the limit relay is configured in the setup. If an error occurs at an input to which a limit value is assigned, the limit relay adopts the configured status. The effect of the limit relay in the event of an error (energizes or de-energizes) must be specified in the setup. If a failure mode with a fixed error substitute value is configured in the assigned input, the corresponding relay does not react to the error at the input. Instead it checks the substitute value for limit value violation and switches depending on the limit value violation. The default value for the relay is "energized".

**Application → Calc value 1/2***Failure mode*

- Invalid:  
The calculated value is not valid and is not output.
- Fixed value:  
It is possible to enter a constant value that is output in the event of an error.

**Diagnostics***Verify HW set*

Following a hardware upgrade (e.g. additional relays, universal inputs etc.), it is necessary to perform hardware verification, i.e. the hardware is checked by the firmware in the device.

The "Verify HW set" function must be enabled in this case.

*Simulation*

The output value of the analog outputs and the switching state of the relays can be specified in the simulation mode. Simulation remains active until it is set to "off". The start and end of the simulation are saved in the diagnostic events.

Expert → Diagnostics → Simulation:

- Select the output to be simulated with the simulation value
- Select the relay to be simulated with the status

## 7.5 In operation

### 7.5.1 + and - quick pick keys

You can use the '+' and '-' quick pick keys to switch through all the active channels (universal inputs and calculated values) in the display mode. The measured value or the calculated value is then displayed for 5 seconds. The channel name pertaining to the value

displayed appears in the color section of the display. The maximum and minimum value are provided for each active channel.

Press the '+' and '-' simultaneously to exit a menu at any time. Any changes made are not saved.

### 7.5.2 Min/Max memory



The device records the highest and lowest values of the inputs and calculated values and saves them cyclically every 15 minutes in the nonvolatile memory.

#### Display:

Select the corresponding channel using the '+' and '-' quick pick keys.

#### Reset the min. and max. values:

Reset in the setup: select the channel (Analog in 1/2, Calc value 1/2), 'Reset min/max', min./max. values of the corresponding channel are reset.

 A reset outside the setup (resetting without a user code) is only possible if this has been enabled for the channel in the setup (Allow reset →  27). Press 'E' and select 'Display'. All the channels for which resetting outside the setup is permitted are displayed in succession. Select the corresponding channel and set to 'yes'. The channel is reset.

### 7.5.3 Device self-diagnosis, failure mode and cable open circuit detection/measuring range limits

The device monitors its inputs for a cable open circuit, as well as its own internal functions, by comprehensive monitoring mechanisms in the device software (e.g. cyclic memory test).

If the device self-diagnosis function detects an error, the device reacts as follows:

- Open collector output switches
- Red LED is lit
- Relay switches (if active and assigned as a fault/alarm relay)
- Display goes to error mode → color of channel affected changes to red and an error is displayed
- Display switches automatically between the active channels and the error

Troubleshooting instructions and a list of all the error messages can be found in the 'Troubleshooting' section →  41.

#### Measuring range limits

Display							
Display	-----	-----	Measured value	-----	-----	-----	Points to note
Status	F	F	Displayed and processed measured value	F	F	F	
Range		Under range		Over range		Invalid measured value	
0 to 20 mA			0 to 22 mA	> 22 mA		Not calibrated	Negative currents are not displayed or calculated (value remains at 0)
4 to 20 mA (without Namur)		≤ 2 mA	> 2 mA < 22 mA	≥ 22 mA		Not calibrated	
4 to 20 mA (as per Namur)	≤ 2 mA <sup>1)</sup> 2 < x ≤ 3.6 mA <sup>2)</sup>	> 3.6 mA to ≤ 3.8 mA	> 3.8 mA to < 20.5 mA	≥ 20.5 mA... < 21 mA	≥ 21 mA <sup>2)</sup>	Not calibrated	As per NAMUR 43
+/- voltage ranges		< -110%	-110%...110%	> 110%		Not calibrated	

Display							
Display	-----	-----	Measured value	-----	-----	-----	Points to note
Status	F	F	Displayed and processed measured value	F	F	F	
Range		Under range		Over range		Invalid measured value	
Voltage ranges from 0 V		< -10%	-10%...110%	> 110%		Not calibrated	
	No further calculation/further calculation with fixed error value		Further calculation in math and as min./max.				
Voltage range 1 to 5 V with activated cable open circuit detection	≤ 0.8 V		1 to 5 V		≥ 5.2 V	Not calibrated	
Thermocouples	Below the lower range limit <sup>2)</sup>		0 to 100%		Above the upper range limit <sup>2)</sup>		Cable open circuit detection from approx. 50 kΩ <sup>1)</sup>
Resistance	Below the lower range limit <sup>1)</sup>		0 to 100%		Above the upper range limit <sup>1)</sup>		
	No further calculation/further calculation with fixed error value		Further calculation in math and as min./max.	No further calculation/further calculation with fixed error value			

1) Cable open circuit

2) Error at sensor

### 7.5.4 Saving diagnostic events/alarms and errors

Diagnostic events such as alarms and fault conditions are saved in the device as soon as a new error occurs or the status of the device changes. The events saved are written to the nonvolatile device memory every 30 minutes.

The device lists the following values in the 'Diagnostics' menu:

- Current device diagnostics
- Last device diagnostics
- Last 5 diagnostic messages

List of error codes, see Troubleshooting →  41.

 It is possible that events saved over the past 30 minutes might be lost.

### 7.5.5 Operating hours counter

The device has an internal operating hours counter which also acts as the reference for diagnostic events.

The operating hours are indicated in the 'Diagnostics' → 'Operating time' menu item. This information cannot be reset or changed.

### 7.5.6 Device reset

Various reset levels are available for a device reset.

**'Expert' → 'System' → 'Reset' → 'Factory reset'**: reset all the parameters to the as-delivered state; all the configured parameters are overwritten.

 If a user code has been defined, it is overwritten!!! When operation is locked by a user code, this is indicated by a lock symbol on the display.

**'Expert' → 'System' → 'Reset' → 'User reset'**: parameters are loaded and configured in accordance with the user setup that is saved; the current configuration or factory settings are overwritten by the user setup.

 If a user code has been defined, it is overwritten by the user code defined in the user setup!!! If no user code was saved in the user setup, the device is no longer locked. When operation is locked by a user code, this is indicated by a lock symbol on the display.



## 8 Diagnostics and troubleshooting

To help you troubleshoot, the following section is designed to provide an overview of possible causes of errors.

### NOTICE

#### Device malfunction possible when retrofitting with untested hardware



- ▶ When retrofitting the device with additional hardware (relay, additional universal input and additional analog output), the device software must perform an internal hardware test). To do so, call up the "Verify HW set" function in the Expert → Diagnostics menu.

### 8.1 General troubleshooting

#### ⚠ WARNING

#### Danger! Electric voltage!

- ▶ Do not operate the device in an open condition for device troubleshooting.

 Error codes that appear on the display are described in the next section →  41. Further information on the failsafe mode is also provided in the "Commissioning" section →  38.

### 8.2 Overview of diagnostic information

 Faults have the highest priority. The corresponding error code is displayed.

### 8.3 Diagnosis list

*The errors are defined as:*

Error code	Meaning	Remedy
F041	Sensor/cable open circuit	Check wiring
F045	Sensor error	Check sensor
F101	Below range	Check measurement, limit value violated
F102	Above range	
F221	Error: Reference junction	Contact your service organization.
F261	Error: Flash	Contact your service organization.
F261	Error: RAM	Contact your service organization.
F261	Error: EEPROM	Contact your service organization.
F261	Error: A/D converter, channel 1	Contact your service organization.
F261	Error: A/D converter, channel 2	Contact your service organization.
F261	Error: invalid device ID	Contact your service organization.
F281	Initialization phase	Contact your service organization.
F282	Error: parameter data could not be saved	Contact your service organization.
F283	Error: incorrect parameter data	Contact your service organization.
F431	Error: incorrect calibration values	Contact your service organization.
C411	Info: upload/download active	For information purposes only. Device is working properly.
C432	Info: calibration/test mode	For information purposes only. Device is working properly.

Error code	Meaning	Remedy
C482	Info: simulation mode, relay/open collector	For information purposes only. Device is working properly.
C483	Info: simulation mode, analog output	For information purposes only. Device is working properly.
C561	Display overrun	For information purposes only. Device is working properly.

## 9 Maintenance

No special maintenance work is required for the device.

### Cleaning

A clean, dry cloth can be used to clean the device.

# 10 Repair

## 10.1 General notes

**i** Repairs that are not described in these Operating Instructions must only be carried out directly by the manufacturer or by the service department.

If ordering spare parts, specify the serial number of the device. Where necessary, installation instructions are supplied with the spare part.

## 10.2 Spare parts

Device spare parts that are currently available can be found online at: <https://www.endress.com/en/instrumentation-services>.

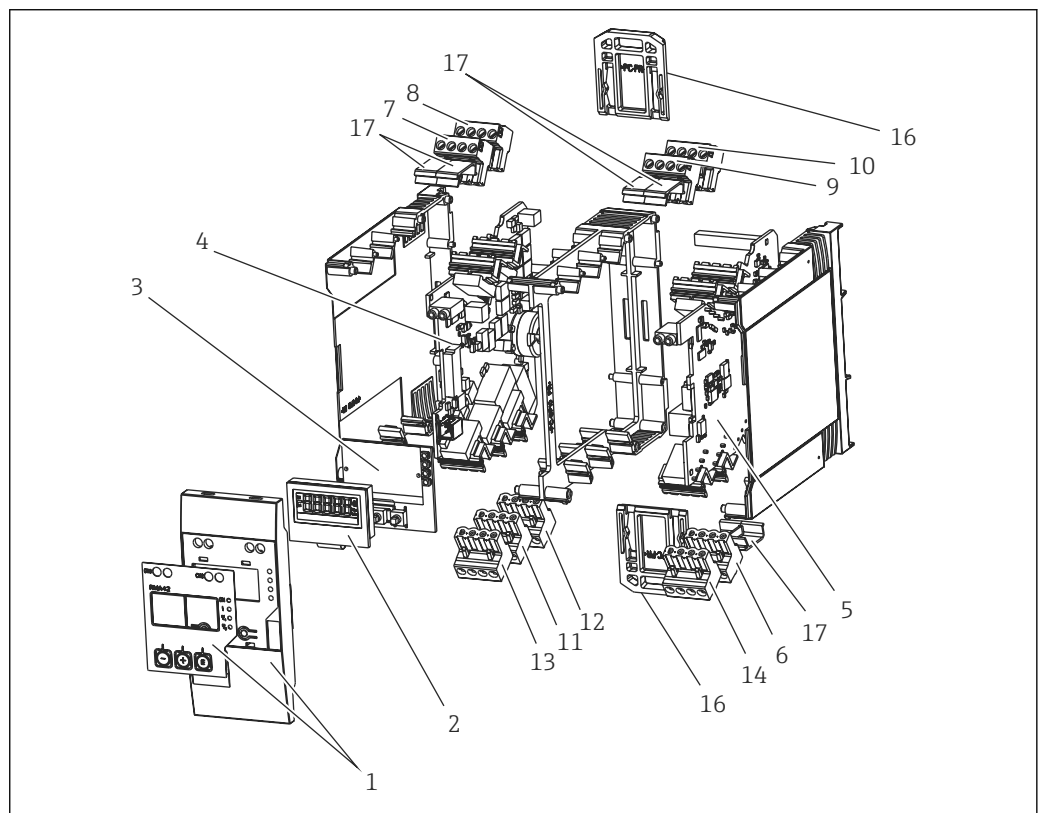

A0012132

**i** 14 Spare parts

Item No.	Designation
1	Front incl. foil
2	Display
3	CPU board (without display)
4	Mainboard 1-channel without relay, non-Ex
	Mainboard 1-channel without relay, Ex
	Mainboard 1-channel with relay, non-Ex
	Mainboard 1-channel with relay, Ex
5	Powerboard without channel 2, non-Ex 24-230 V (-20% +10%)
	Powerboard without channel 2, Ex 24-230 V (-20% +10%)

Item No.	Designation
	Powerboard with channel 2, non-Ex 24-230 V (-20% +10%)
	Powerboard with channel 2, Ex 24-230 V (-20% +10%)
6	4-pin terminals for supply voltage "N/- \ L/+"
7	Terminals, input 1 Ex, "11 12 13 14" blue
	Terminals, input 1 non-Ex, "11 12 13 14" gray
8	Terminals, input 1 Ex, "15 16 17 18" blue
	Terminals, input 1 non-Ex, "15 16 17 18" gray
9	Terminals, input 2 Ex, " 21 22 23 24" blue
	Terminals, input 2 non-Ex, " 21 22 23 24" gray
10	Terminals, input 2 Ex, "25 26 27 28" blue
	Terminals, input 2 non-Ex, "25 26 27 28" gray
11	Terminals, relay output 1 (R13, R11, R12)
12	Terminals, relay output 2 (R23, R21, R22)
13	Terminals, analog output 1 and status output (O16 O15 D12 D11)
14	Terminals, analog output 2 (O25, O26)
16	Fix slide (2 pcs)
17	Terminal cover set (5 pcs)

## 10.3 Return

The requirements for safe device return can vary depending on the device type and national legislation.

1. Refer to the web page for information:  
<http://www.endress.com/support/return-material>  
↳ Select the region.
2. Return the device if repairs or a factory calibration are required, or if the wrong device was ordered or delivered.

## 10.4 Disposal

### 10.4.1 IT security

Observe the following instructions before disposal:

1. Delete the data
2. Reset the device

### 10.4.2 Removing the measuring device

1. Switch off the device
2. Carry out the mounting and connection steps from the "Mounting the measuring device" and "Connecting the measuring device" sections in reverse order. Observe the safety instructions.

### 10.4.3 Disposing of the measuring device



If required by the Directive 2012/19/EU on waste electrical and electronic equipment (WEEE), the product is marked with the depicted symbol in order to minimize the disposal of WEEE as unsorted municipal waste. Do not dispose of products bearing this marking as unsorted municipal waste. Instead, return them to the manufacturer for disposal under the applicable conditions.

## 11 Accessories

Various accessories are available for the device, and can be ordered with the device or at a later stage from Endress+Hauser. Detailed information on the specific order code is available from your local Endress+Hauser sales organization or on the product page of the Endress+Hauser website: [www.endress.com](http://www.endress.com).

### 11.1 Communication-specific accessories

Designation
Interface cable
Commubox TXU10 incl. FieldCare Device Setup and DTM Library
Commubox FXA291 incl. FieldCare Device Setup and DTM Library

## 12 Technical data

### 12.1 Input

#### 12.1.1 Measured variable

Current, voltage, resistance, resistance thermometer, thermocouples

#### 12.1.2 Measuring ranges

Current:

- 0/4 to 20 mA +10% overrange
- Short-circuit current: max. 150 mA
- Load: 10  $\Omega$

Voltage:

- 0 to 10 V, 2 to 10 V, 0 to 5 V, 0 to 1 V, 1 to 5 V,  $\pm 1$  V,  $\pm 10$  V,  $\pm 30$  V,  $\pm 100$  mV
- Max. permitted input voltage:
  - Voltage  $\geq 1$  V:  $\pm 35$  V
  - Voltage  $< 1$  V:  $\pm 12$  V
- Input impedance:  $> 1\,000$  k $\Omega$

Resistance:

30 to 3 000  $\Omega$

Resistance thermometer:

- Pt100 as per IEC60751, GOST, JIS1604
- Pt500 and Pt1000 as per IEC60751
- Cu100, Cu50, Pt50, Pt46, Cu53 as per GOST
- Ni100, Ni1000 as per DIN 43760

Thermocouple types:

- Typ J, K, T, N, B, S, R as per IEC60584
- Typ U as per DIN 43710
- Typ L as per DIN 43710, GOST
- Typ C, D as per ASTM E998

#### 12.1.3 Number of inputs

One or two universal inputs

#### 12.1.4 Update time

200 ms

#### 12.1.5 Galvanic isolation

Towards all other circuits

### 12.2 Output

#### 12.2.1 Output signal

One or two analog outputs, galvanically isolated

**Current/voltage output**

Current output:

- 0/4 to 20 mA
- Overrange up to 22 mA

Voltage:

- 0 to 10 V, 2 to 10 V, 0 to 5 V, 1 to 5 V
- Overrange: up to 11 V, short-circuit proof,  $I_{max} < 25 \text{ mA}$

**HART®**

HART® signals are not affected

**12.2.2 Loop power supply**

- Open-circuit voltage:  $24 V_{DC} (+15\% / -5\%)$
- Ex version:  $> 14 \text{ V}$  at 22 mA
- Non-Ex version with SIL:  $> 14 \text{ V}$  at 22 mA
- Non-Ex version without SIL:  $> 16 \text{ V}$  at 22 mA
- Maximum 30 mA short-circuit-proof and overload-proof
- Galvanically isolated from system and outputs

**12.2.3 Switching output**

Open Collector for monitoring of the device state and alarm notification. The OC output is closed in normal state. In error state, the OC output is opened.

- $I_{max} = 200 \text{ mA}$
- $U_{max} = 28 \text{ V}$
- $U_{on/max} = 2 \text{ V}$  at 200 mA

Galvanic isolation towards all other circuits; test voltage 500 V

**12.2.4 Relay output**

Relay output for limit function

Relay contact	Changeover
Maximum contact burden DC	30 V / 3 A (permanent state, without destruction of the input)
Maximum contact burden AC	250 V / 3 A (permanent state, without destruction of the input)
Minimum contact load	500 mW (12 V/10 mA)
Galvanic isolation towards all other circuits	Test voltage 1 500 $V_{AC}$
Switching cycles	$> 1 \text{ million}$



## 12.3 Power supply

### 12.3.1 Terminal assignment

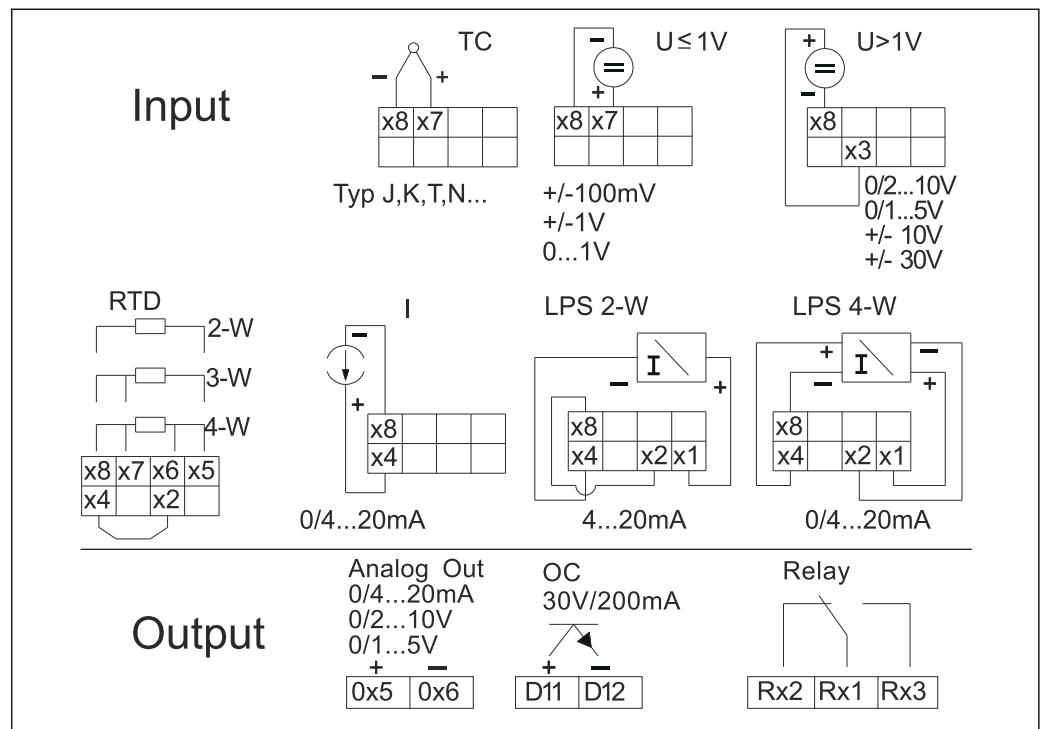

15 Terminal assignment of the process transmitter (relay (terminals Rx1-Rx3) and channel 2 (terminals 21-28 and 025/026) optional). Note: Illustrated contact position of the relays if the limit value is breached or the power supply fails.



### 12.3.2 Supply voltage

Wide range power supply 24 to 230 V AC/DC (-20 % / +10 %) 50/60 Hz

### 12.3.3 Power consumption

Max. 21.5 VA / 6.9 W

### 12.3.4 Interface connection data

#### Commubox FXA291 PC USB interface

- Connection: 4-pin socket
- Transmission protocol: FieldCare
- Transmission rate: 38,400 baud

#### Interface cable TXU10-AC PC USB interface

- Connection: 4-pin socket
- Transmission protocol: FieldCare
- Order configuration: interface cable with FieldCare Device Setup DVD incl. all Comm DTMs and Device DTMs

## 12.4 Performance characteristics

### 12.4.1 Reference operating conditions

Power supply: 230 V<sub>AC</sub>, 50/60 Hz

Ambient temperature: 25 °C (77 °F) ± 5 °C (9 °F)

Humidity: 20 %...60 % rel. humidity

### 12.4.2 Maximum measured error

Universal input:

Accuracy	Input:	Range:	Maximum measured error of measuring range (oMR):
	Current	0 to 20 mA, 0 to 5 mA, 4 to 20 mA; Overrange: up to 22 mA	±0.05%
	Voltage ≥ 1 V	0 to 10 V, 2 to 10 V, 0 to 5 V, 1 to 5 V, 0 to 1 V, ±1 V, ±10 V, ±30 V	±0.1%
	Voltage < 1 V	±100 mV	±0.05%
	Resistance measurement	30 to 3 000 Ω	4-wire: ± (0.10% oMR + 0.8 Ω) 3-wire: ± (0.10% oMR + 1.6 Ω) 2-wire: ± (0.10% oMR + 3 Ω)
	RTD	Pt100, -200 to 850 °C (-328 to 1562 °F) (IEC60751, α=0.00385) Pt100, -200 to 850 °C (-328 to 1562 °F) (JIS1604, w=1.391) Pt100, -200 to 649 °C (-328 to 1200 °F) (GOST, α=0.003916) Pt500, -200 to 850 °C (-328 to 1562 °F) (IEC60751, α=0.00385) Pt1000, -200 to 600 °C (-328 to 1112 °F) (IEC60751, α=0.00385)	4-wire: ± (0.10% oMR + 0.3 K (0.54 °F)) 3-wire: ± (0.10% oMR + 0.8 K (1.44 °F)) 2-wire: ± (0.10% oMR + 1.5 K (2.7 °F))
		Cu100, -200 to 200 °C (-328 to 392 °F) (GOST, w=1.428) Cu50, -200 to 200 °C (-328 to 392 °F) (GOST, w=1.428) Pt50, -200 to 1100 °C (-328 to 2012 °F) (GOST, w=1.391) Pt46, -200 to 850 °C (-328 to 1562 °F) (GOST, w=1.391) Ni100, -60 to 250 °C (-76 to 482 °F) (DIN43760, α=0.00617) Ni1000, -60 to 250 °C (-76 to 482 °F) (DIN43760, α=0.00617)	4-wire: ± (0.10% oMR + 0.3 K (0.54 °F)) 3-wire: ± (0.10% oMR + 0.8 K (1.44 °F)) 2-wire: ± (0.10% oMR + 1.5 K (2.7 °F))
		Cu53, -50 to 200 °C (-58 to 392 °F) (GOST, w=1.426)	4-wire: ± (0.10% oMR + 0.3 K (0.54 °F)) 3-wire: ± (0.10% oMR + 0.8 K (1.44 °F)) 2-wire: ± (0.10% oMR + 1.5 K (2.7 °F))
	Thermocouples	Typ J (Fe-CuNi), -210 to 1200 °C (-346 to 2192 °F) (IEC60584)	± (0.10% oMR + 0.5 K (0.9 °F)) from -100 °C (-148 °F)
		Typ K (NiCr-Ni), -200 to 1372 °C (-328 to 2502 °F) (IEC60584)	± (0.10% oMR + 0.5 K (0.9 °F)) from -130 °C (-202 °F)
		Typ T (Cu-CuNi), -270 to 400 °C (-454 to 752 °F) (IEC60584)	± (0.10% oMR + 0.5 K (0.9 °F)) from -200 °C (-328 °F)
		Typ N (NiCrSi-NiSi), -270 to 1300 °C (-454 to 2372 °F) (IEC60584)	± (0.10% oMR + 0.5 K (0.9 °F)) from -100 °C (-148 °F)
		Typ L (Fe-CuNi), -200 to 900 °C (-328 to 1652 °F) (DIN43710, GOST)	± (0.10% oMR + 0.5 K (0.9 °F)) from -100 °C (-148 °F)

Accuracy	Input:	Range:	Maximum measured error of measuring range (oMR):
		Typ D (W3Re/W25Re), 0 to 2495 °C (32 to 4523 °F) (ASTME998)	± (0.15% oMR + 1.5 K (2.7 °F)) from 500 °C (932 °F)
		Typ C (W5Re/W26Re), 0 to 2320 °C (32 to 4208 °F) (ASTME998)	± (0.15% oMR + 1.5 K (2.7 °F)) from 500 °C (932 °F)
		Typ B (Pt30Rh-Pt6Rh), 0 to 1820 °C (32 to 3308 °F) (IEC60584)	± (0.15% oMR + 1.5 K (2.7 °F)) from 600 °C (1112 °F)
		Typ S (Pt10Rh-Pt), -50 to 1768 °C (-58 to 3214 °F) (IEC60584)	± (0.15% oMR + 3.5 K (6.3 °F)) for -50 to 100 °C (-58 to 212 °F) ± (0.15% oMR + 1.5 K (2.7 °F)) from 100 °C (212 °F)
		Typ U (Cu-CuNi), -200 to 600 °C (-328 to 1112 °F) (DIN 43710)	± (0.15% oMR + 1.5 K (2.7 °F)) from 100 °C (212 °F)
AD converter resolution		16 bit	
Temperature drift		Temperature drift: ≤ 0.01%/K (0.1%/18 °F) oMR ≤ 0.02%/K (0.2%/18 °F) oMR for Cu100, Cu50, Cu53, Pt50 and Pt46	

### Analog output:

Current	0/4 to 20 mA, overrange up to 22 mA	±0.05% of measuring range
	Max. load	500 Ω
	Max. inductivity	10 mH
	Max. capacity	10 μF
	Max. ripple	10 mVpp at 500 Ω, frequency < 50 kHz
Voltage	0 to 10 V, 2 to 10 V 0 to 5 V, 1 to 5 V Overrange: up to 11 V, shortcircuit proof, $I_{max} < 25$ mA	±0.05% of measuring range ±0.1 % of measuring range
	Max. ripple	10 mVpp at 1000 Ω, frequency < 50 kHz
Resolution	13 bit	
Temperature drift	≤ 0.01%/K (0.1%/18 °F) of measuring range	
Galvanic isolation	Testing voltage of 500 V towards all other circuits	

## 12.5 Installation

### 12.5.1 Mounting location

Mounting on top-hat rail as per IEC 60715.

### 12.5.2 Orientation

Vertical or horizontal.

#### NOTICE

**Heat accumulation when installing several devices on a vertically mounted top-hat rail**

- Keep sufficient gaps between the individual devices.

## 12.6 Environment

### 12.6.1 Ambient temperature

#### NOTICE

**Operation in the upper temperature range reduces the operating life of the display.**

- ▶ To avoid heat buildup, always ensure that the device is sufficiently cooled.

Non-Ex/Ex devices: -20 to 60 °C (-4 to 140 °F)

UL devices: -20 to 50 °C (-4 to 122 °F)

### 12.6.2 Storage temperature

-40 to 85 °C (-40 to 185 °F)

### 12.6.3 Operating altitude

< 2 000 m (6 560 ft) above MSL

### 12.6.4 Climate class

To IEC 60654-1, Class B2

### 12.6.5 Degree of protection

DIN rail housing IP 20

### 12.6.6 Electrical safety

Class II equipment, overvoltage category II, pollution degree 2

### 12.6.7 Condensation

Not permitted

### 12.6.8 Electromagnetic compatibility (EMC)

#### CE conformity

Electromagnetic compatibility in accordance with all the relevant requirements of the IEC/EN 61326 series. For details refer to the EU Declaration of Conformity.

- Maximum measured error < 1% of measuring range
- Interference immunity according to IEC/EN 61326 series, requirement industrial area
- Interference emission according to IEC/EN 61326 series (CISPR 11) Group 1 Class A

 This unit is not intended for use in residential environments and cannot guarantee adequate protection of the radio reception in such environments.

## 12.7 Mechanical construction

### 12.7.1 Design, dimensions

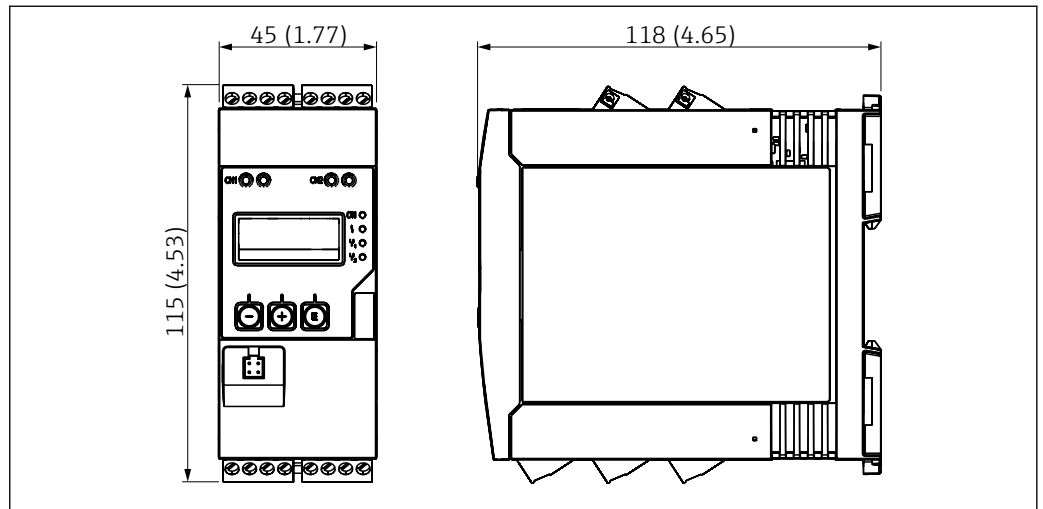

16 Dimensions of the process transmitter in mm (in)

A0011792

### 12.7.2 Weight

Approximately 300 g (10.6 oz)

### 12.7.3 Material

Housing: plastic PC-GF10

### 12.7.4 Terminals

Screw terminals, plug-in, 2.5 mm<sup>2</sup> (14 AWG), 0.1 to 4 mm<sup>2</sup> (30 to 12 AWG), torque 0.5 to 0.6 Nm (0.37 to 0.44 lbf ft)

## 12.8 Operability

### 12.8.1 Local operation

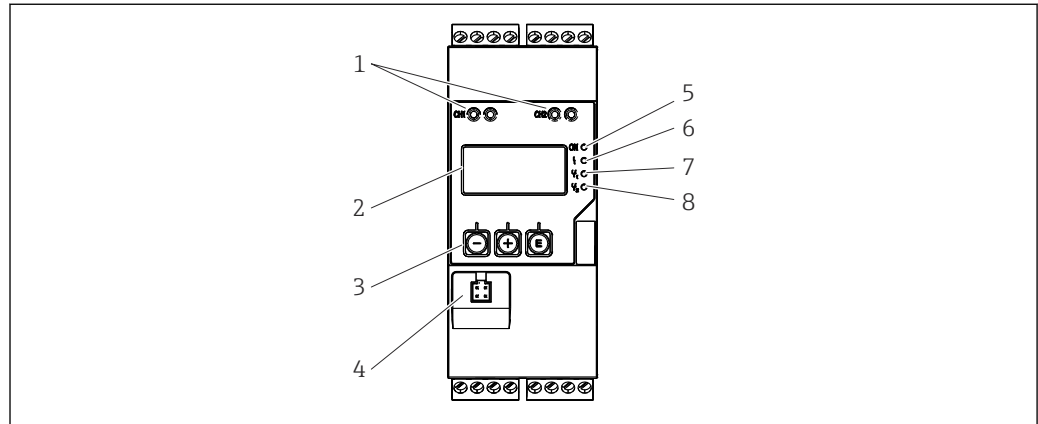

A0011767

17 Display and operating elements of the process transmitter

- 1 HART® connection sockets
- 2 Display
- 3 Operating keys
- 4 PC interface connection port
- 5 Green LED; on = supply voltage applied
- 6 Red LED; on = error/alarm
- 7 Yellow LED; on = relay 1 energized
- 8 Yellow LED; on = relay 2 energized

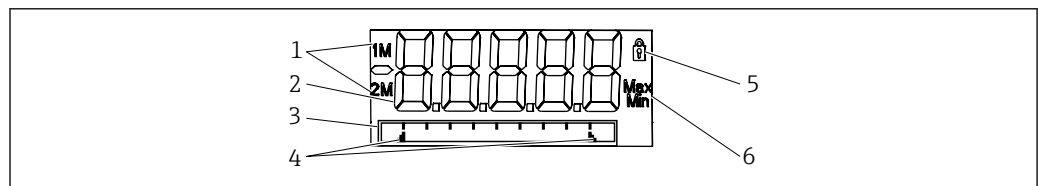

A0011765

18 Display of the process transmitter

- 1 Channel display: 1: analog input 1; 2: analog input 2; 1M: calculated value 1; 2M: calculated value 2
- 2 Measured value display
- 3 Dot matrix display for TAG, bar graph and unit
- 4 Limit value indicators in the bar graph
- 5 "Operation locked" indicator
- 6 Minimum/maximum value indicator

- Display
  - 5-digit, 7-segment backlit LC display
  - Dot matrix for text/bar graph
- Display range
  - 99999 to +99999 for measured values
- Signaling
  - Setup security locking (lock)
  - Measuring range overshoot/undershoot
  - 2 x status relay (only if relay option was selected)

#### Operating elements

3 keys: -, +, E

## 12.8.2 Remote operation

### Configuration

The device can be configured with the PC software or on site using the operating keys. FieldCare Device Setup is delivered together with the Commubox FXA291 or TXU10-AC (see 'Accessories') or can be downloaded free of charge from [www.endress.com](http://www.endress.com).

### Interface

4-pin socket for the connection with a PC via Commubox FXA291 or TXU10-AC interface cable (see 'Accessories')

## 12.9 Certificates and approvals

### 12.9.1 Other standards and guidelines

- IEC 60529:  
Degrees of protection provided by enclosures (IP code)
- IEC 61010-1:  
Safety requirements for electrical equipment for measurement, control and laboratory use
- EN 60079-11:  
Explosive atmospheres - Part 11: Equipment protection by intrinsic safety "I" (optional)

## 13 Appendix

All the parameters available in the configuration menu are listed in the following tables. The values preconfigured at the factory are marked in bold.

### 13.1 Further explanations regarding the differential pressure application in level measurement

Pressure sensors are connected at both universal inputs. The volume in the CV channels is ultimately calculated with the following calculation steps.

#### 13.1.1 1st calculation step: calculation of the filling level

Both pressure sensors provide the actual pressure at the installation point. A pressure difference ( $\Delta p$ ) is determined from both pressures (adjusted by an offset where applicable; this offset must be set in AI1 or AI2). The measured height is calculated by dividing the pressure difference by the density of the medium and multiplying by the gravitational acceleration.

$$\text{Height } h = \Delta p / (\rho * g)$$

The calculation is based on the following units:

- Density  $\rho$  [kg/m<sup>3</sup>]
- Pressure  $p$ : [Pa] or [N/m<sup>2</sup>]

The gravitational acceleration is defined by a constant:

$$\text{Gravitational acceleration } g = 9.81 \text{ m/s}^2$$

#### NOTICE

##### Wrong calculation results due to the use of incorrect units

- To obtain a correct calculation, a measured signal (e.g. in mbar) may need to be converted to the correct unit. This is done using a conversion factor. Conversion factors are indicated in the table → 57.

##### Examples of conversion:

Water: density  $\rho = 1000 \text{ kg/m}^3$

Pressure measurement: pressure 1 (bottom): scale 0 to 800 mbar (0 to 80000 Pa);

Present value: 500 mbar (50000 Pa)

Pressure measurement: pressure 2 (head): scale 0 to 800 mbar (0 to 80000 Pa);

Present value: 150 mbar (15000 Pa)

If using Pascal:

$$h = \frac{1}{1000 \text{ kg/m}^3 * 9.81 \text{ m/s}^2} * (50000 - 15000 \text{ Pa}) = 3.57 \text{ m}$$

If using mbar:

$$h = \frac{1}{1000 \text{ kg/m}^3 * 9.81 \text{ m/s}^2} * ((500 - 150 \text{ mbar}) * (1.0000 * 10^2)) = 3.57 \text{ m}$$

$$h = b * \Delta p$$

Calculation of the correction factor  $b$ :

$$b = 1 / (\rho * g)$$

$$\text{for water: } b = 1 / (1000 * 9.81) = 0.00010194$$

Tables and examples for the conversion of application-related units into the defined values kg/m<sup>3</sup> and Pa and N/m<sup>2</sup>:



- 1 bar = 0.1 N/mm<sup>2</sup> = 10<sup>5</sup> N/m<sup>2</sup> = 10<sup>5</sup> Pa
- 1 mbar = 1 hPa = 100 Pa

*Conversion factors for various pressure engineering units*

	Pascal	Bar	Technical atmosphere	Physical atmosphere	Torr	Pounds per square inch
	[Pa]	[bar]	[at]	[atm]	[torr]	[psi]
	= 1 N/m <sup>2</sup>	= 1 Mdyn/cm <sup>2</sup>	= 1 kp/cm <sup>2</sup>	= 1 pSTP	= 1 mmHg	= 1 lbf/in <sup>2</sup>
1 Pa =	1	1.000 · 10 <sup>-4</sup>	1.0197 · 10 <sup>-5</sup>	9.8692 · 10 <sup>-6</sup>	7.5006 · 10 <sup>-3</sup>	1.4504 · 10 <sup>-4</sup>
1 bar =	1.000 · 10 <sup>5</sup>	1	1.0197 · 10 <sup>0</sup>	9.8692 · 10 <sup>-1</sup>	7.5006 · 10 <sup>2</sup>	1.4504 · 10 <sup>1</sup>
1 mbar =	1.000 · 10 <sup>2</sup>	1.000 · 10 <sup>-3</sup>	1.0197 · 10 <sup>3</sup>	9.8692 · 10 <sup>-4</sup>	7.5006 · 10 <sup>-1</sup>	1.4504 · 10 <sup>-2</sup>
1 at =	9.8067 · 10 <sup>4</sup>	9.8067 · 10 <sup>-1</sup>	1	9.6784 · 10 <sup>-1</sup>	7.3556 · 10 <sup>2</sup>	1.4223 · 10 <sup>1</sup>
1 atm =	1.0133 · 10 <sup>5</sup>	1.0133 · 10 <sup>0</sup>	1.0332 · 10 <sup>0</sup>	1	7.6000 · 10 <sup>2</sup>	1.4696 · 10 <sup>1</sup>
1 torr =	1.3332 · 10 <sup>2</sup>	1.3332 · 1 <sup>-3</sup>	1.3595 · 10 <sup>-3</sup>	1.3158 · 10 <sup>-3</sup>	1	1.9337 · 10 <sup>-2</sup>
1 psi =	6.8948 · 10 <sup>3</sup>	6.8948 · 1 <sup>-3</sup>				

### Density:

Refer to the specifications of the medium in the tank for the density.

The table below lists standard approximate values, which provide initial orientation.

Medium	Density in [kg/m <sup>3</sup> ]
Water (at 3.98 °C (39.164 °F))	999.975
Mercury	13 595
Bromine	3 119
Sulfuric acid	1834
Nitric acid	1512
Glycerine	1260
Nitrobenzene	1220
Deuterium oxide	1105
Acetic acid	1049
Milk	1030
Seawater	1025
Aniline	1022
Olive oil	910
Benzene	879
Toluene	872
Essence of turpentine	855
Methylated spirit	830
Diesel fuel	830
Petroleum	800
Methanol	790
Ethanol	789
Gasoline (standardized, average value)	750
Acetone	721

Medium	Density in [kg/m <sup>3</sup> ]
Carbon disulfide	713
Diethyl ether	713

### 13.1.2 2nd calculation step: calculation of the volumetric content from the height

The volume can be calculated using the linearization of the calculated height value.

This is done by assigning a certain volume value to every height value, depending on the tank shape.

This linearization is mapped over up to 32 linearization points (support points). However, 2-3 linearization points suffice if the dependency between the filling level and volume is very linear.

The tank linearization module integrated in FieldCare provides support here.

## 13.2 Display menu

---

### AI1/AI2 Reset minmax

---

<b>Navigation</b>	 Display → AI1 Reset minmax/AI2 Reset minmax
<b>Description</b>	Resets the saved minimum and maximum values of analog input 1 or analog input 2.
<b>Selection</b>	Yes No
<b>Factory setting</b>	No
<b>Additional information</b>	Only available if "Allow reset = yes" has been configured in the menu Expert → Analog in 1/Analog in 2.

---

### Cv1/Cv2 Reset minmax

---

<b>Navigation</b>	 Display → Cv1 Reset minmax/Cv2 Reset minmax
<b>Description</b>	Resets the saved minimum and maximum values of math 1 or math 2.
<b>Selection</b>	Yes No
<b>Factory setting</b>	No
<b>Additional information</b>	Only available if "Allow reset = yes" has been configured in the menu Expert → Calc val 1/Calc val 2.

---

### Analog in 1/2

---

<b>Navigation</b>	 Display → Analog in 1/Analog in 2
<b>Description</b>	Configuration of the display for analog input 1 or analog input 2. If the parameter is set to 'Off', the channel is not displayed.
<b>Selection</b>	Off Unit Bar graph Bar + unit Tag + unit
<b>Factory setting</b>	Tag + unit

---

 Calc value 1/2
 

---

<b>Navigation</b>	☰ Display → Calc value 1/Calc value 1
<b>Description</b>	Configuration of the display for math 1 or math 2. If the parameter is set to 'Off', the channel is not displayed.
<b>Selection</b>	Off Unit Bar graph Bar + unit Tag + unit
<b>Factory setting</b>	Off

---

 Contrast
 

---

<b>Navigation</b>	☰ Display → Contrast
<b>Description</b>	Sets the display contrast
<b>Selection</b>	1...7
<b>Factory setting</b>	6

---

 Brightness
 

---

<b>Navigation</b>	☰ Display → Brightness
<b>Description</b>	Sets the brightness
<b>Selection</b>	1...7
<b>Factory setting</b>	6

---

 Alternating time
 

---

<b>Navigation</b>	☰ Display → Alternating time
<b>Description</b>	Setting for the time for toggling between the displayed channels.
<b>Selection</b>	3 seconds 5 seconds 10 seconds
<b>Factory setting</b>	5 seconds

## 13.3 Setup menu

---

 Application
 

---

<b>Navigation</b>	☰ Setup → Application
<b>Description</b>	Configuration of the application for the process indicator.
<b>Selection</b>	1-channel 2-channel Diff pressure
<b>Factory setting</b>	1- / 2-channel
<b>Additional information</b>	2-channel is the default setting for two-channel devices, 1-channel for single-channel devices.

---

 AI1/AI2 Lower range
 

---

<b>Navigation</b>	 Setup → AI1 Lower range/AI2 Lower range
<b>Description</b>	Setting for the measuring range lower limit.
<b>User entry</b>	Numerical value <sup>1)</sup>
<b>Factory setting</b>	0.0000
<b>Additional information</b>	Only visible if Application → Diff pressure is configured.

---

 AI1/AI2 Upper range
 

---

<b>Navigation</b>	 Setup → AI1 Upper range/AI2 Upper range
<b>Description</b>	Setting for measuring range upper limit.
<b>User entry</b>	Numerical value <sup>1)</sup>
<b>Factory setting</b>	100.00
<b>Additional information</b>	Only visible if Application → Diff pressure is configured.

---

 CV factor
 

---

<b>Navigation</b>	 Setup → CV factor
<b>Description</b>	Factor by which the calculated value is multiplied.
<b>User entry</b>	Numerical value <sup>1)</sup>
<b>Factory setting</b>	1.0
<b>Additional information</b>	Only visible if Application → Diff pressure is configured.

---

 CV unit
 

---

<b>Navigation</b>	 Setup → CV unit
<b>Description</b>	Unit of the calculated value
<b>Selection</b>	Customized text, max. 5 characters
<b>Additional information</b>	Only visible if Application → Diff pressure is configured.

---

 CV Bar 0%
 

---

<b>Navigation</b>	 Setup → CV Bar 0%
<b>Description</b>	Setting for the 0% value for the bar graph
<b>User entry</b>	Numerical value <sup>1)</sup>
<b>Factory setting</b>	0.0000
<b>Additional information</b>	Only visible if Application → Diff pressure is configured.

---

 CV Bar 100%
 

---

<b>Navigation</b>	 Setup → CV Bar 100%
<b>Description</b>	Setting for the 0% value for the bar graph
<b>User entry</b>	Numerical value <sup>1)</sup>

<b>Factory setting</b>	100.00
<b>Additional information</b>	Only visible if Application → Diff pressure is configured.

---

 "Linearization" submenu
 

---

<b>Navigation</b>	☰ Setup → Linearization
<b>Description</b>	Only visible if Application → Diff pressure is configured.

---

 No lin points
 

---

<b>Navigation</b>	☰ Setup → Linearization → No lin points
<b>Description</b>	Number of linearization points
<b>User entry</b>	2...32
<b>Factory setting</b>	2

---

 X-value 1...X-value 32
 

---

<b>Navigation</b>	☰ Setup → Linearization → X-value 1...X-value 32
<b>Description</b>	X-value for the linearization point
<b>User entry</b>	Numerical value <sup>1)</sup>
<b>Factory setting</b>	0.0000

---

 Y-value 1...Y-value 32
 

---

<b>Navigation</b>	☰ Setup → Linearization → Y-value 1...Y-value 32
<b>Description</b>	Y-value for the linearization point
<b>User entry</b>	Numerical value <sup>1)</sup>
<b>Factory setting</b>	0.0000

---

 Submenu "Analog in 1"/"Analog in 2"
 

---

<b>Navigation</b>	☰ Setup → Analog in 1/Analog in 2
<b>Additional information</b>	Settings for analog input 1 or analog input 2

---

 Signal type
 

---

<b>Navigation</b>	☰ Setup → Analog in 1/Analog in 2 → Signal type
<b>Description</b>	Setting for the input type.
<b>Selection</b>	Off Current Voltage RTD TC
<b>Factory setting</b>	Current
<b>Additional information</b>	If the Signal type is set to 'off', all the parameters under it are hidden.

Signal range	
<b>Navigation</b>	☰ Setup → Analog in 1/Analog in 2 → Signal range
<b>Description</b>	Setting for the input signal. The options that are available for selection depend on the "Signal type" that is set.
<b>Selection</b>	4-20mA, 4-20mA squar, 0-20mA, 0-20mA squar 0-10V, 0-10V squar, 0-5V, 2-10V, 1-5V, 1-5V squar, 0-1V, 0-1V squar, +/- 1V, +/- 10V, +/- 30V, +/- 100mV Pt46GOST, Pt50GOST, Pt100IEC, Pt100JIS, Pt100GOST, Pt500IEC, Pt1000IEC, Ni100DIN, Ni1000DIN, Cu50GOST, Cu53GOST, Cu100GOST, 3000 Ohm Type B, Type J, Type K, Type N, Type R, Type S, Type T, Type C, Type D, Type L, Type L GOST, Type U
<b>Factory setting</b>	4-20mA, 0-10V, Pt100IEC, Type J; depending on the selected input signal
Lower range	
<b>Navigation</b>	☰ Setup → Analog in 1/Analog in 2 → Lower range
<b>Description</b>	Setting for the measuring range lower limit.
<b>User entry</b>	Numerical value <sup>1)</sup>
<b>Factory setting</b>	0
<b>Additional information</b>	Only visible for "Signal type" = "Current" or "Voltage"
Upper range	
<b>Navigation</b>	☰ Setup → Analog in 1/Analog in 2 → Upper range
<b>Description</b>	Setting for measuring range upper limit.
<b>User entry</b>	Numerical value <sup>1)</sup>
<b>Factory setting</b>	100
<b>Additional information</b>	Only visible for "Signal type" = "Current" or "Voltage"
Connection	
<b>Navigation</b>	☰ Setup → Analog in 1/Analog in 2 → Connection
<b>Description</b>	Setting for the connection type for the resistance thermometer.
<b>Selection</b>	2-wire 3-wire 4-wire
<b>Factory setting</b>	2-wire
<b>Additional information</b>	Only visible for "Signal type" = "RTD"
Tag	
<b>Navigation</b>	☰ Setup → Analog in 1/Analog in 2 → Tag
<b>Description</b>	Channel name; TAG is the device designation for channel 1
<b>User entry</b>	Customized text, max. 12 characters

---

 Unit
 

---

<b>Navigation</b>	☰ Setup → Analog in 1/Analog in 2 → Unit
<b>Description</b>	Unit of the channel.
<b>User entry</b>	Customized text, max. 5 characters
<b>Additional information</b>	Only visible for "Signal type" = "Current" or "Voltage"

---

 Temperature unit
 

---

<b>Navigation</b>	☰ Setup → Analog in 1/Analog in 2 → Temperature unit
<b>Description</b>	Setting for the temperature unit.
<b>Selection</b>	°C °F K
<b>Factory setting</b>	°C
<b>Additional information</b>	Only visible for "Signal type" = "RTD" or "TC"

---

 Offset
 

---

<b>Navigation</b>	☰ Setup → Analog in 1/Analog in 2 → Offset
<b>Description</b>	Setting for an offset
<b>User entry</b>	Numerical value <sup>1)</sup>
<b>Factory setting</b>	0

---

 Ref junction
 

---

<b>Navigation</b>	☰ Setup → Analog in 1/Analog in 2 → Ref junction
<b>Description</b>	Setting for reference temperature.
<b>Selection</b>	Internal Fixed
<b>Factory setting</b>	Internal
<b>Additional information</b>	Only visible for "Signal type" = "TC"

---

 Fixed ref junc
 

---

<b>Navigation</b>	☰ Setup → Analog in 1/Analog in 2 → Fixed ref junc
<b>Description</b>	Setting for constant reference temperature.
<b>User entry</b>	Numerical value <sup>1)</sup>
<b>Additional information</b>	Only visible if "Ref junction" = "Fixed".

---

 Reset min/max
 

---

<b>Navigation</b>	☰ Setup → Analog in 1/Analog in 2 → Reset min/max
-------------------	---

<b>Description</b>	Reset the saved min/max values.
<b>Selection</b>	No Yes
<b>Factory setting</b>	No

---

 Submenu "Calc value 1"/"Calc value 2"
 

---

<b>Navigation</b>	 Setup → Calc value 1/Calc value 2
<b>Additional information</b>	Settings for Math 1 or Math 2

---

 Calculation
 

---

<b>Navigation</b>	 Setup → Calc value 1/Calc value 2 → Calculation
<b>Description</b>	Selection of calculation method.
<b>Selection</b>	Off Sum Difference Average Lineariz. AI1 / Lineariz. AI2 Lineariz. CV1 (only Calc value 2) Multiplication
<b>Factory setting</b>	Off
<b>Additional information</b>	If Calculation is set to 'off', all the parameters under it are hidden.

---

 Tag
 

---

<b>Navigation</b>	 Setup → Calc value 1/Calc value 2 → Tag
<b>Description</b>	Channel name
<b>User entry</b>	Customized text, max. 12 characters

---

 Unit
 

---

<b>Navigation</b>	 Setup → Calc value 1/Calc value 2 → Unit
<b>Description</b>	Unit of the channel
<b>User entry</b>	Customized text, max. 5 characters

---

 Bar 0%
 

---

<b>Navigation</b>	 Setup → Calc value 1/Calc value 2 → Bar 0%
<b>Description</b>	Setting for the 0% value for the bar graph
<b>User entry</b>	Numerical value <sup>1)</sup>
<b>Factory setting</b>	0

---

 Bar 100%
 

---

<b>Navigation</b>	 Setup → Calc value 1/Calc value 2 → Bar 100%
-------------------	--



<b>Description</b>	Setting for the 100% value for the bar graph
<b>User entry</b>	Numerical value <sup>1)</sup>
<b>Factory setting</b>	100

---

Factor

---

<b>Navigation</b>	 Setup → Calc value 1/Calc value 2 → Factor
-------------------	--

<b>Description</b>	Setting for the factor for the calculated value
<b>User entry</b>	Numerical value <sup>1)</sup>
<b>Factory setting</b>	1.0

---

Offset

---

<b>Navigation</b>	 Setup → Calc value 1/Calc value 2 → Offset
-------------------	--

<b>Description</b>	Setting for an offset
<b>User entry</b>	Numerical value <sup>1)</sup>
<b>Factory setting</b>	0

---

No. lin points

---

<b>Navigation</b>	 Setup → Calc value 1/Calc value 2 → No. lin points
-------------------	--

<b>Description</b>	Number of linearization points
<b>User entry</b>	2...32
<b>Factory setting</b>	2
<b>Additional information</b>	Only visible if "Calculation" = "Linearization".

---

X-value

---

<b>Navigation</b>	 Setup → Calc value 1/Calc value 2 → X-value
-------------------	---

<b>Description</b>	Enter the support points (linearization points) for linearization (max. 32).
<b>User entry</b>	X-value 1...X-value 32, a numerical value in each case <sup>1)</sup>
<b>Factory setting</b>	0
<b>Additional information</b>	Only visible if "Calculation" = "Linearization".

---

Y-value

---

<b>Navigation</b>	 Setup → Calc value 1/Calc value 2 → Y-value
-------------------	---

<b>Description</b>	Enter the support points (linearization points) for linearization (max. 32).
<b>User entry</b>	Y-value 1...Y-value 32, a numerical value in each case <sup>1)</sup>
<b>Factory setting</b>	0
<b>Additional information</b>	Only visible if "Calculation" = "Linearization".

---

Reset min/max

---

<b>Navigation</b>	 Setup → Calc value 1/Calc value 2 → Reset min/max
-------------------	---

<b>Description</b>	Reset the saved min/max values.
<b>Selection</b>	No Yes
<b>Factory setting</b>	No

---

 Submenu "Analog Out 1"/"Analog Out 2"
 

---

<b>Navigation</b>	 Setup → Analog Out 1/Analog Out 2
<b>Additional information</b>	Settings for analog output 1 or analog output 2

---

 Assignment
 

---

<b>Navigation</b>	 Setup → Analog Out 1/Analog Out 2 → Assignment
<b>Description</b>	For selecting the source for the output signal
<b>Selection</b>	Off Analog 1 Analog 2 Calc Val 1 Calc Val 2
<b>Factory setting</b>	Off

---

 Signal type
 

---

<b>Navigation</b>	 Setup → Analog Out 1/Analog Out 2 → Signal type
<b>Description</b>	For selecting the signal type for the output signal
<b>Selection</b>	4-20mA 0-20mA 0-10V 2-10V 0-5V 1-5V
<b>Factory setting</b>	4-20mA

---

 Lower range
 

---

<b>Navigation</b>	 Setup → Analog Out 1/Analog Out 2 → Lower range
<b>Description</b>	Setting for the measuring range lower limit
<b>User entry</b>	Numerical value <sup>1)</sup>
<b>Factory setting</b>	0

---

 Upper range
 

---

<b>Navigation</b>	 Setup → Analog Out 1/Analog Out 2 → Upper range
<b>Description</b>	Setting for measuring range upper limit
<b>User entry</b>	Numerical value <sup>1)</sup>
<b>Factory setting</b>	100

---

 Submenu "Relay 1"/"Relay 2"
 

---

<b>Navigation</b>	☰ Setup → Relay 1/Relay 2
<b>Additional information</b>	Settings for relay 1 or relay 2

---

 Source
 

---

<b>Navigation</b>	☰ Setup → Relay 1/Relay 2 → Source
<b>Description</b>	For selecting the source for the relay
<b>Selection</b>	Off Analog input 1 Analog input 2 Calc value 1 Calc value 2 Error
<b>Factory setting</b>	Off

---

 Function
 

---

<b>Navigation</b>	☰ Setup → Relay 1/Relay 2 → Function
<b>Description</b>	Function of the relay
<b>Selection</b>	Min Max Gradient Inband Outband
<b>Factory setting</b>	Min

---

 Setpoint
 

---

<b>Navigation</b>	☰ Setup → Relay 1/Relay 2 → Setpoint
<b>Description</b>	Switching threshold for relay
<b>User entry</b>	Numerical value <sup>1)</sup>
<b>Factory setting</b>	0

---

 Setpoint 2
 

---

<b>Navigation</b>	☰ Setup → Relay 1/Relay 2 → Setpoint 2
<b>Description</b>	Second switching threshold for relay.
<b>User entry</b>	Numerical value <sup>1)</sup>
<b>Factory setting</b>	0
<b>Additional information</b>	Only for the Inband and Outband functions.

---

 Time base
 

---

<b>Navigation</b>	☰ Setup → Relay 1/Relay 2 → Time base
-------------------	---------------------------------------

<b>Description</b>	Time base for gradient evaluation in seconds.
<b>User entry</b>	0-60
<b>Factory setting</b>	0
<b>Additional information</b>	Only visible if "Function" = "Gradient".

---

Hysteresis

---

<b>Navigation</b>	 Setup → Relay 1/Relay 2 → Hysteresis
<b>Description</b>	Hysteresis for switching threshold(s)
<b>User entry</b>	Numerical value <sup>1)</sup>
<b>Factory setting</b>	0

---

"System" submenu

---

<b>Navigation</b>	 Setup → System
-------------------	--

---

Access code



---

<b>Navigation</b>	 Setup → System → Access code
<b>Description</b>	User code to protect the device configuration.
<b>User entry</b>	0000...9999
<b>Factory setting</b>	0000
<b>Additional information</b>	0000 = protection disabled by user code

---

Overfill protect

---

<b>Navigation</b>	 Setup → System → Overfill protect
<b>Description</b>	If the device is used for overfill protection →  34, Overfill protect = yes must be set.
<b>Selection</b>	No Yes
<b>Factory setting</b>	No

---

Reset

---

<b>Navigation</b>	 Setup → System → Reset
<b>Description</b>	Reset the device to the as-delivered state
<b>Selection</b>	No Yes
<b>Factory setting</b>	No

1) Numerical values consist of 6 digits, wherein the decimal point counts as a digit, e.g. +99.999

## 13.4 Diagnostics menu

---

Current diagn

---

---

**Navigation**  Diagnostics → Current diagn

**Description** Displays the error code currently active

---

Last diagn

---

**Navigation**  Diagnostics → Last diagn

**Description** Displays the last error code

---

Operating time

---

**Navigation**  Diagnostics → Operating time

**Description** Displays the operating hours up until now

---

Submenu "Diagnost logbook"

---

**Navigation**  Diagnostics → Diagnost logbook

**Description** Displays the last 5 error codes

---

Diagnostics x

---

**Navigation**  Diagnostics → Diagnost logbook → Diagnostics x

**Description** Displays a message from the Diagnostics logbook.

---

Submenu "Device information"

---

**Navigation**  Diagnostics → Device information

---

Device tag

---

**Navigation**  Diagnostics → Device information → Device tag

**Description** Display the device name, TAG, channel 1

---

Serial number

---

**Navigation**  Diagnostics → Device information → Serial number

**Description** Displays the serial number

---

Order code

---

**Navigation**  Diagnostics → Device information → Order code

**Description** Displays the order code

---

---

 Order identifier
 

---

**Navigation**  Diagnostics → Device information → Order identifier

**Description** Displays the order code

---

 Firmware version
 

---

**Navigation**  Diagnostics → Device information → Firmware version

**Description** Displays the firmware version

---

 ENP version
 

---

**Navigation**  Diagnostics → Device information → ENP Version

**Description** Displays the ENP version

## 13.5 Expert menu

In addition to all the parameters from the Setup menu, the following parameters are also available in the Expert Mode.

---

 Direct access
 

---

**Navigation**  Expert → Direct access

**Description** Code to go directly to an operating item

**User entry** 4-digit code

---

 "System" submenu
 

---

**Navigation**  Expert → System

---

 Save user setup
 

---

**Navigation**  Expert → System → Save user setup

**Description** Select 'Yes' to save the current device settings. The device can be reset to the saved settings via 'Reset'-'>'User reset'.

**Selection** No  
Yes

**Factory setting** No

---

 Submenu "Input"
 

---

**Navigation**  Expert → Input

---

 Submenu "Analog in 1"/"Analog in 2"
 

---

<b>Navigation</b>	☰ Expert → Input → Analog in 1/Analog in 2
<b>Description</b>	Settings for the analog inputs.
<b>Additional information</b>	The following parameters are available for analog input 1 and for analog input 2.

---

 Bar 0%
 

---

<b>Navigation</b>	☰ Expert → Input → Analog in 1/Analog in 2 → Bar 0%
<b>Description</b>	Setting for the 0% value for the bar graph
<b>User entry</b>	Numerical value <sup>1)</sup>
<b>Factory setting</b>	0

---

 Bar 100%
 

---

<b>Navigation</b>	☰ Expert → Input → Analog in 1/Analog in 2 → Bar 100%
<b>Description</b>	Setting for the 100% value for the bar graph
<b>User entry</b>	Numerical value <sup>1)</sup>
<b>Factory setting</b>	100

---

 Decimal places
 

---

<b>Navigation</b>	☰ Expert → Input → Analog in 1/Analog in 2 → Decimal places
<b>Description</b>	Setting for the number of decimal places for the display
<b>Selection</b>	XXXXX XXXX.X XXX.XX XX.XXX X.XXXX
<b>Factory setting</b>	XXX.XX

---

 Damping
 

---

<b>Navigation</b>	☰ Expert → Input → Analog in 1/Analog in 2 → Damping
<b>Description</b>	Setting for the damping of the input signal. Enter value in 0.1 s increments from 0.0 s to 999.9 s.
<b>User entry</b>	Numerical value <sup>1)</sup>
<b>Factory setting</b>	0.0 for current / voltage 1.0 for temperature inputs

---

 Failure mode
 

---

<b>Navigation</b>	☰ Expert → Input → Analog in 1/Analog in 2 → Failure mode
-------------------	---

<b>Description</b>	Setting for the failure mode.
<b>Selection</b>	Invalid Fixed value
<b>Factory setting</b>	Invalid
<b>Additional information</b>	Invalid: An invalid value is output in the event of an error. Fixed value: A fixed value is output in the event of an error.

---

Fixed fail value

---

<b>Navigation</b>	 Expert → Input → Analog in 1/Analog in 2 → Fixed fail value
<b>Description</b>	The value set here is output in the event of an error.
<b>User entry</b>	Numerical value <sup>1)</sup>
<b>Factory setting</b>	0
<b>Additional information</b>	Only visible if Failure mode = Fixed value.

---

NAMUR NE 43

---

<b>Navigation</b>	 Expert → Input → Analog in 1/Analog in 2 → Namur NE 43
<b>Description</b>	Setting whether the failure mode should be according to NAMUR NE 43.
<b>Selection</b>	On Off
<b>Factory setting</b>	On

---

Open circ detect

---

<b>Navigation</b>	 Expert → Input → Analog in 1/Analog in 2 → Open circ detect
<b>Description</b>	Setting for cable open circuit detection.
<b>Selection</b>	On Off
<b>Factory setting</b>	On
<b>Additional information</b>	Only visible if 1-5 V is set for the signal range.

---

Failure delay

---

<b>Navigation</b>	 Expert → Input → Analog in 1/Analog in 2 → Failure delay
<b>Description</b>	Delay time for fault in seconds
<b>User entry</b>	Integer (0-99)
<b>Factory setting</b>	0

---

Allow reset

---

<b>Navigation</b>	 Expert → Input → Analog in 1/Analog in 2 → Allow reset
<b>Description</b>	Setting specifying whether saved min/max values in the Display menu can be reset without entering a (configured) user code.
<b>Selection</b>	No Yes
<b>Factory setting</b>	No



---

 Submenu "Output"
 

---

**Navigation**  Expert → Output

---

 Submenu "Analog Out 1"/"Analog Out 2"
 

---

**Navigation**  Expert → Output → Analog Out 1/Analog Out 2

**Description** Settings for the analog outputs.

**Additional information** The following parameters are available for analog output 1 and analog output 2.

---

 Failure mode
 

---

**Navigation**  Expert → Output → Analog Out 1/Analog Out 2 → Failure mode

**Description** Setting for the failure mode.

**Selection**  
Min  
Max  
Fixed value

**Factory setting** Min

**Additional information** Min: The saved minimum value is output in the event of an error.  
Max: The saved maximum value is output in the event of an error.  
Fixed value: A fixed value is output in the event of an error.

---

 Fixed fail value
 

---

**Navigation**  Expert → Output → Analog Out 1/Analog Out 2 → Fixed fail value

**Description** The value set here is output in the event of an error.

**User entry** Numerical value<sup>1)</sup>

**Factory setting** 0

**Additional information** Only visible if Failure mode = Fixed value.

---

 Submenu "Relay 1"/"Relay 2"
 

---

**Navigation**  Expert → Output → Relay 1/Relay 2

**Description** Settings for the relays.

**Additional information** The following parameters are available for relay 1 and relay 2.

---

 Time delay
 

---

**Navigation**  Expert → Output → Relay 1/Relay 2 → Time delay

**Description** Delay to switch the relay in seconds.

**User entry** 0-9999

**Factory setting** 0

---

 Operating mode
 

---

---

<b>Navigation</b>	 Expert → Output → Relay 1/Relay 2 → Operating mode
<b>Description</b>	Normally closed = NC contact Normally opened = NO contact
<b>Selection</b>	Normally closed Normally opened
<b>Factory setting</b>	Normally closed

---

## Failure mode

---

<b>Navigation</b>	 Expert → Output → Relay 1/Relay 2 → Failure mode
<b>Description</b>	Normally closed = NC contact Normally opened = NO contact
<b>Selection</b>	Normally closed Normally opened
<b>Factory setting</b>	Normally closed

---

## Submenu "Application"

---

<b>Navigation</b>	 Expert → Application
-------------------	--

---

## Submenu "Calc value 1"/"Calc value 2"

---

<b>Navigation</b>	 Expert → Application → Calc value 1/Calc value 2
<b>Description</b>	Settings for the math channels.
<b>Additional information</b>	The following parameters are available for math 1 and math 2.

---

## Decimal places

---

<b>Navigation</b>	 Expert → Application → Calc value 1/Calc value 2 → Decimal places
<b>Description</b>	Setting for the number of decimal places for the display
<b>Selection</b>	XXXXX XXXX.X XXX.XX XX.XXX X.XXXX
<b>Factory setting</b>	XXX.XX

---

## Failure mode

---

<b>Navigation</b>	 Expert → Application → Calc value 1/Calc value 2 → Failure mode
<b>Description</b>	Setting for failure mode
<b>Selection</b>	Invalid Fixed value
<b>Factory setting</b>	Invalid

---

## Fixed fail value

---

<b>Navigation</b>	☰ Expert → Application → Calc value 1/Calc value 2 → Fixed fail value
<b>Description</b>	The value set here is output in the event of an error.
<b>User entry</b>	Numerical value <sup>1)</sup>
<b>Factory setting</b>	0
<b>Additional information</b>	Only visible if Failure mode = Fixed value.

---



---

#### Allow reset

---

<b>Navigation</b>	☰ Expert → Application → Calc value 1/Calc value 2 → Allow reset
<b>Description</b>	Setting specifying whether saved min/max values in the Display menu can be reset without entering a (configured) user code.
<b>Selection</b>	No Yes
<b>Factory setting</b>	No

---



---

#### Submenu "Diagnostics"

---

<b>Navigation</b>	☰ Expert → Diagnostics
-------------------	------------------------

---



---

#### Verify HW set

---

<b>Navigation</b>	☰ Expert → Diagnostics → Verify HW set
<b>Description</b>	Verification of the device hardware.
<b>Selection</b>	Yes No
<b>Factory setting</b>	No

---



---

#### Submenu "Simulation"

---

<b>Navigation</b>	☰ Expert → Simulation
-------------------	-----------------------

---



---

#### Simulation AO1/AO2

---

<b>Navigation</b>	☰ Expert → Simulation → Simulation AO1/Simulation AO1
<b>Description</b>	Simulation of analog output 1 or analog output 2. The value set in the simulation is output at analog output 1 or analog output 2.
<b>Selection</b>	Off 0mA 3.6mA 4mA 10mA 12mA 20mA 21mA 0V 5 V 10V
<b>Factory setting</b>	Off

---

**Simu relay 1/2**

---

<b>Navigation</b>	 Expert → Simulation → Simu relay 1/Simu relay 2
<b>Description</b>	Simulation of relay 1 or relay 2.
<b>Selection</b>	Off Closed Opened
<b>Factory setting</b>	Off

1) Numerical values consist of 6 digits, wherein the decimal point counts as a digit, e.g. +99.999

# Index

## A

Access protection . . . . .	33
Application conditions Configuration . . . . .	25
Approval guidelines for overfill protection units (ZG- ÜS) . . . . .	34

## C

Cable open circuit detection . . . . .	38
Configuration Access protection . . . . .	33
Advanced device configuration . . . . .	33
Analog output . . . . .	29
Application conditions . . . . .	25
Calculations . . . . .	28
Code . . . . .	33
Differential pressure application . . . . .	26
Display functions . . . . .	34
Expert . . . . .	35
Limit values . . . . .	29
Overfill protection . . . . .	34
Relay . . . . .	29
Setup menu item . . . . .	27
Universal input . . . . .	27
Configuration via configuration software . . . . .	17
Connection . . . . .	13

## D

Delay and hysteresis active . . . . .	32
Device configuration General Information . . . . .	24
Setup access protection . . . . .	24
Device reset . . . . .	39
Diagnosis list . . . . .	41
Differential pressure application . . . . .	26
Dimensions . . . . .	11
Display . . . . .	19
Display functions . . . . .	34
Display symbols . . . . .	20

## E

Error codes . . . . .	41
Expert menu . . . . .	35

## F

Failure mode . . . . .	38
------------------------	----

## H

Hysteresis and delay active . . . . .	32
---------------------------------------	----

## I

Incoming acceptance . . . . .	9
Installation requirements . . . . .	11

## L

Local operation . . . . .	17
---------------------------	----

## M

Measuring range limits . . . . .	38
Min/Max memory . . . . .	38

## N

Nameplate . . . . .	9
---------------------	---

## O

Operating elements . . . . .	17
Operating hours counter . . . . .	39
Operating matrix . . . . .	21
Operational safety . . . . .	7
Overfill protection . . . . .	34

## P

Parameter Access code . . . . .	68
AI1/AI2 Lower range . . . . .	60
AI1/AI2 Reset minmax . . . . .	58
AI1/AI2 Upper range . . . . .	60
Allow reset . . . . .	72, 75
Alternating time . . . . .	59
Analog in 1/2 . . . . .	58
Application . . . . .	59
Assignment . . . . .	66
Bar 0% . . . . .	64, 71
Bar 100% . . . . .	64, 71
Brightness . . . . .	59
Calc value 1/2 . . . . .	59
Calculation . . . . .	64
Connection . . . . .	62
Contrast . . . . .	59
Current diagn . . . . .	68
CV Bar 0% . . . . .	60
CV Bar 100% . . . . .	60
CV factor . . . . .	60
CV unit . . . . .	60
Cv1/Cv2 Reset minmax . . . . .	58
Damping . . . . .	71
Decimal places . . . . .	71, 74
Device tag . . . . .	69
Diagnostics x . . . . .	69
Direct access . . . . .	70
ENP version . . . . .	70
Factor . . . . .	65
Failure delay . . . . .	72
Failure mode . . . . .	71, 73, 74
Firmware version . . . . .	70
Fixed fail value . . . . .	72, 73, 74
Fixed ref junction . . . . .	63
Function . . . . .	67
Hysteresis . . . . .	68
Last diagn . . . . .	69
Lower range . . . . .	62, 66
NAMUR NE 43 . . . . .	72
No line points . . . . .	61

No. lin points . . . . .	65
Offset . . . . .	63, 65
Open circ detect . . . . .	72
Operating mode . . . . .	73
Operating time . . . . .	69
Order code . . . . .	69
Order identifier . . . . .	70
Overfill protect . . . . .	68
Ref junction . . . . .	63
Reset . . . . .	68
Reset min/max . . . . .	63, 65
Save user setup . . . . .	70
Serial number . . . . .	69
Setpoint . . . . .	67
Setpoint 2 . . . . .	67
Signal range . . . . .	62
Signal type . . . . .	61, 66
Simu relay 1/2 . . . . .	76
Simulation AO1/AO2 . . . . .	75
Source . . . . .	67
Tag . . . . .	62, 64
Temperature unit . . . . .	63
Time base . . . . .	67
Time delay . . . . .	73
Unit . . . . .	63, 64
Upper range . . . . .	62, 66
Verify HW set . . . . .	75
X-value . . . . .	65
X-value 1...X-value 32 . . . . .	61
Y-value . . . . .	65
Y-value 1...Y-value 32 . . . . .	61
Post-connection check . . . . .	16
Product safety . . . . .	8
<b>Q</b>	
Quick pick keys . . . . .	37
<b>R</b>	
Relay	
Operating mode	
Gradient . . . . .	31
InBand . . . . .	32
Max . . . . .	30
Min . . . . .	30
Off . . . . .	30
OutBand . . . . .	31
Specification . . . . .	30
Requirements for personnel . . . . .	7
Reset . . . . .	39
Return . . . . .	44
<b>S</b>	
Saving alarms . . . . .	39
Saving diagnostic events . . . . .	39
Saving the setup . . . . .	33
Self-diagnosis . . . . .	38
Spare parts . . . . .	43
Storage . . . . .	10

<b>Submenu</b>	
Analog in 1/2 . . . . .	61, 71
Analog Out 1/2 . . . . .	66, 73
Application . . . . .	74
Calc value 1/2 . . . . .	64, 74
Device information . . . . .	69
Diagnost logbook . . . . .	69
Diagnostics . . . . .	75
Input . . . . .	70
Linearization . . . . .	61
Output . . . . .	73
Relay 1/2 . . . . .	67, 73
Simulation . . . . .	75
System . . . . .	68, 70
Symbols . . . . .	20
<b>T</b>	
Transporting . . . . .	10
<b>W</b>	
Workplace safety . . . . .	7





71563194

[www.addresses.endress.com](http://www.addresses.endress.com)

---