

Item	Part No.	Description
1	AK453X.V3-P01	CYLINDER BLOCK
2	AK453X.V3-P02	O-RING 67x2.65
3	AK453X.V3-P03	O-RING 58.42x2.62
4	AK453X.V3-P04	AIR MOTOR SHELL OUTSIDE
5	AK453X.V3-P05	AIR MOTOR SHELL INSIDE
6	AK453X.V3-P06	AIR MOTOR COVER
7	AK453X.V3-P07	NUT
8	AK453X.V3-P08	RUBBER PISTON
9	AK453X.V3-P09	GASKET
10	AK453X.V3-P10	PISTON SHAFT
11	AK453X.V3-P11	PISTON ROD GUIDE SLEEVE
12	AK453X.V3-P12	O RING 11.2x2.65
13	AK453X.V3-P13	O RING 18.77x1.78
14	AK453X.V3-P14	SLIDING SLEEVE
15	AK453X.V3-P15	CENTRE SHAFT
16	AK453X.V3-P16	OD SEAL
17	AK453X.V3-P17	SEALING SOCKET
18	AK453X.V3-P18	O-RING 20.29x2.62
19	AK453X.V3-P19	O-RING 11.5x2
20	AK453X.V3-P20	GASKET
21	AK453X.V3-P21	CONNECT SHELL
22	AK453X.V3-P22	ROLL PIN
23	AK453X.V3-P23	CONNECT SHAFT 'NEW TYPE' (10x428)
--	AK453X.V3-P23A	CONNECT SHAFT 'OLD TYPE' (10x425)
24	AK453X.V3-P24	OUTER SLEEVE
25	AK453X.V3-P25	COMPRESSION SPRING
26	SB-6.0	STEEL BALL 6.0mm
27	AK453X.V3-P27	PISTON
28	AK453X.V3-P28	SPRING SEAT
29	AK453X.V3-P29	SHAFT

Item	Part No.	Description
30	AK453X.V3-P30	PLUG SLEEVE
31	AK453X.V3-P31	VALVE SET
33	AK453X.V3-P33	FILTER PLATE
34	AK453X.V3-P34	CIRCLIP (26mm)
35	AK453X.V3-P35	EXTRACT PLATE
36	NLN6.S	NYLOC NUT M6 ZINC DIN 985 (SINGLE)
37	AK453X.V3-P37	TUBE
38	AK453X.V3-P38	O-RING (23.53x1.78)
39	ATV2040.34	O-RING (20x2)
40	AK453X.V3-P40	TOGGLE BLOCK
41	AK453X.V3-P41	OUTER SPRING FIXED SEAT
42	AK453X.V3-P42	COMPRESSION SPRING
43	AK453X.V3-P43	INNER SPRING FIXED SEAT
44	AK453X.V3-P44	JOINT
45	AK453X.V3-P45	SEAL COVER
46	AK453X.V3-P46	QUICK COUPLING
47	AK453X.V3-P47	SILENCER
48	AK453X.V3-P48	CIRCLIP (16mm)
49	AK453X.V3-P49	O-RING (39.34x2.62)
50	AK453X.V3-P50	LIMIT PLATE
51	AK453X.V3-P51	GASKET
52	AK453X.V3-P52	O-RING
53	AK453X.V3-P53	SILENCER
54	AK453X.V3-P54	CIRCLIP (16mm)
55	AK453X.V3-P55	PANEL
56	AK453X.V3-P56	PLATE
57	AK453X.V3-P57	BOLT (M4x10)
58	AK453X.V3-P58	SPRING WASHER (4mm)
59	SWM4.S	SPRING WASHER M4 (SINGLE)

NOTE: It is our policy to continually improve products and as such we reserve the right to alter data, specifications and component parts without prior notice.

IMPORTANT: No liability is accepted for incorrect use of product.

WARRANTY: Guarantee is 12 months from purchase date, proof of which will be required for any claim.

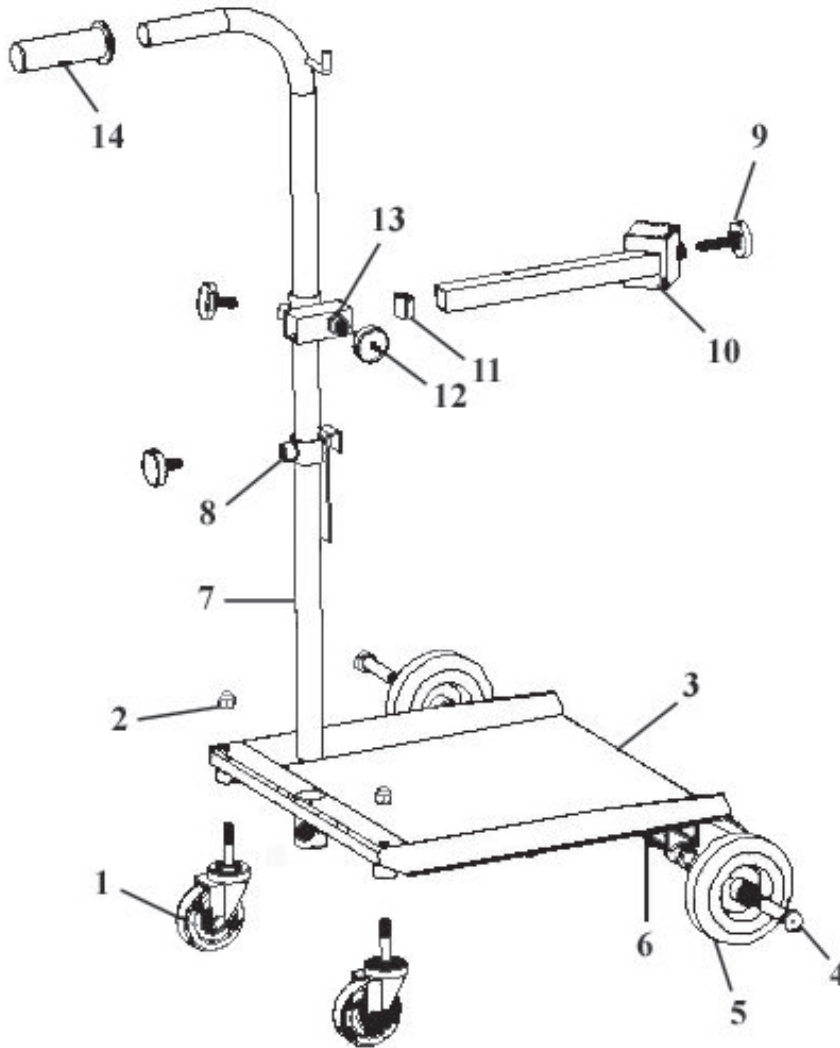

Item	Part No.	Description
--	AK453X.V3-T	TROLLEY ASS'Y COMPLETE
1	AK453X.V3-T01	WHEEL,CASTOR (75x9x25x93)
2	SN10.SD	STEEL NUT M10 DOMED (SINGLE)
3	AK453X.V3-T03	TROLLEY BASE
4	HHB1490.S	HEX HEAD BOLT M14x90mm SINGLE
5	AK453X.V3-T05	WHEEL,FIXED (125x14x37)
6	AK453X.V3-T06	HEX NUT
7	AK453X.V3-T07	HANDLE
8	AK453X.V3-T08	FIXING NUT
9	AK453X.V3-T09	KNOB SCREW (M10x45)
10	AK453X.V3-T10	GREASE GUN HOLDER

Item	Part No.	Description
11	AK453X.V3-T11	END PLUG
12	AK453X.V3-T12	KNOB SCREW (M10x25)
13	AK453X.V3-T13	PUMP SUPPORT
14	AK453X.V3-T14	HANDLE GRIP
--	AK453X.V3-01	GREASE PUMP
--	AK452X.V4-03	DRUM COVER (280mm)
--	AK452X.V4-04	FOLLOWER PLATE (265mm)
--	AK453X.V3-05	HIGH PRESSURE GREASE HOSE (4m)
--	AK453X.V3-06	GREASE CONTROL GUN
--	AK453X.V3-07	FILTER/REGULATOR/LUBRICATOR COMPLETE
--	AK453X.V3-08	Z SWIVEL

NOTE: It is our policy to continually improve products and as such we reserve the right to alter data, specifications and component parts without prior notice.

IMPORTANT: No liability is accepted for incorrect use of product.

WARRANTY: Guarantee is 12 months from purchase date, proof of which will be required for any claim.