

# E12362

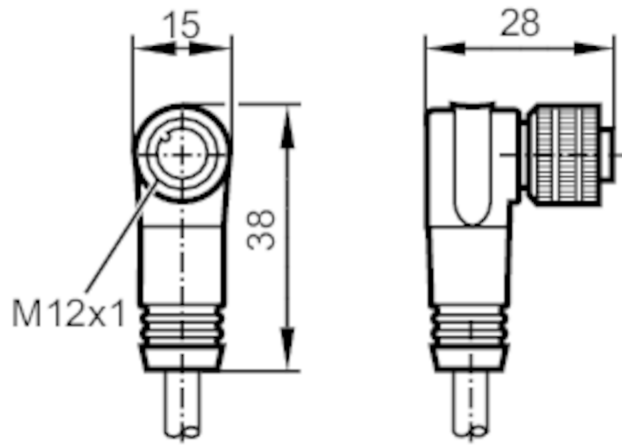

## Connecting cable with socket

ADOAH080MSS0001H08



Application	
Special feature	Free from silicone; Halogen-free; Gold-plated contacts
Free from silicone	yes
Electrical data	
Operating voltage [V]	< 30 AC / < 36 DC
Protection class	III
Max. current load total [A]	2; (...40 °C)
Operating conditions	
Ambient temperature [°C]	-25...80
Protection	IP 67
Mechanical data	
Weight [g]	78.8
Dimensions [mm]	28 x 15 x 38
Materials	PUR
Material nut	brass, nickel-plated
Remarks	
Notes	For 8-pole sockets the core colours are not standardised.; Please note the wiring of the sensor and the sockets (see data sheet).
Pack quantity	1 pcs.
Electrical connection	
Cable: 1 m, PUR, Halogen-free, black, Ø 6.2 mm; 8 x 0.25 mm <sup>2</sup>	
Electrical connection - socket	
Connector: 1 x M12, angled; Moulded body: PUR; Locking: brass, nickel-plated; Contacts: gold-plated; Tightening torque: 0.7...0.9 Nm	

# E12362



## Connecting cable with socket

ADOAH080MSS0001H08



### Connection

1	BN
2	WH
3	BU
4	BK
5	GY
6	PK
7	VT
8	OG

colours to DIN EN 60947-5-2

Core colours :

BK =	black
BN =	brown
BU =	blue
GY =	grey
PK =	pink
OG =	orange
VT =	lilac
WH =	white