

# SCC Series

## High Capacitance Cylindrical SuperCapacitors



The new series of cylindrical electrochemical double-layer capacitors offers excellent pulse power handling characteristics based on the combination of very high capacitance and very low ESR. Used by themselves or in conjunction with primary or secondary batteries, they provide extended back up time, longer battery life, and provide instantaneous power pulses as needed. Offers great solutions to Hold Up, Energy Harvesting, and Pulse Power Applications.

### FEATURES

- Cap Values from 1F – 3000F
- High pulse power capability
- Low ESR
- Low Leakage Current

### APPLICATIONS

- Camera Flash Systems
- Energy Harvesting
- GSM/GPRS Pulse Applications
- UPS/Industrial
- Wireless Alarms
- Remote Metering
- Scanners
- Toys and Games

### HOW TO ORDER

<b>SCC</b>	<b>R</b>	<b>12</b>	<b>B</b>	<b>105</b>	<b>P</b>	<b>R</b>	<b>B</b>	<b>-</b>
<b>Series</b> SuperCap Cylindrical	<b>Diameter</b> Q = 6.3mm R = 8mm S = 10mm T = 12.5mm U = 16mm V = 18mm W = 22mm X = 30mm Y = 35mm Z = 60mm	<b>Case Length</b> Two digits represent case length in mm, with the exception of the following: 1E = 138mm	<b>Voltage Code</b> B = 2.7V	<b>Capacitance Code</b> 1st two digits represent significant figures 3rd digit represents multiplier (number of zeros to follow)	<b>Tolerance</b> P = +100%/-0% S = +30%/-10%	<b>Lead Format</b> R = Radial S = Solder Pin C = Cylindrical Lug W = Screw	<b>Package</b> B = Bulk T = Tray*	<b>Custom Code</b> A1= 4mm Bent Leads* C1 = 2mm Bent Leads*

\*Inquire about availability

### QUALITY INSPECTIONS

Parts are tested for Life Cycle, high temperature load life, temperature characteristics, vibration resistance, and humidity characteristics. See page 2 for more information.

### TERMINATION

These SuperCapacitors are compatible with hand soldering, as well as reflow and wave soldering processes, so long as appropriate precautions are followed. See page 4 for more information.

### OPERATING TEMPERATURE

-40°C to +65°C @ 2.7V  
-40°C to +85°C @ 2.3V



For RoHS compliant products,  
please select correct termination style.

### RATING & PART NUMBER REFERENCE

AVX Part Number	Diameter (mm)	Length (mm)	Rated Capacitance (F)	Capacitance Tolerance	Rated Voltage (V)	Rated Temperature (°C)	DCL Max @ 72 Hrs (µA)	ESR Max @ 1000 Hz (mΩ)	ESR Max @ DC (mΩ)	Peak Current (A)	Power Density (W/kg)	Max Energy (Wh)	Energy Density (Wh/kg)
<b>Radial Lead</b>													
SCCQ12B105PRB	6.3	12	1	+100%/-0%	2.7/2.3*	65/85*	6	200	500	0.90	2692	0.0010	1.56
SCCR12B105PRB	8	12	1	+100%/-0%	2.7/2.3*	65/85*	6	150	500	0.90	1842	0.0010	1.07
SCCR16B205PRB	8	16	2	+100%/-0%	2.7/2.3*	65/85*	10	100	360	1.57	2113	0.0020	1.76
SCCR20B335PRB	8	20	3.3	+100%/-0%	2.7/2.3*	65/85*	12	95	290	2.28	2080	0.0033	2.30
SCCR25B505PRB	8	25	5	+100%/-0%	2.7/2.3*	65/85*	15	85	220	3.21	2339	0.0051	2.98
SCCS20B505PRB	10	20	5	+100%/-0%	2.7/2.3*	65/85*	15	70	180	3.55	2314	0.0051	2.41
SCCS25B705PRB	10	25	7	+100%/-0%	2.7/2.3*	65/85*	20	60	150	4.61	2243	0.0071	2.73
SCCS30B106PRB	10	30	10	+100%/-0%	2.7/2.3*	65/85*	30	40	75	7.71	3763	0.0101	3.27
SCCT20B106PRB	12.5	20	10	+100%/-0%	2.7/2.3*	65/85*	30	50	75	7.71	3431	0.0101	2.98
SCCT30B156SRB	12.5	30	15	+30%/-10%	2.7/2.3*	65/85*	50	35	80	9.20	2430	0.0152	3.38
SCCU25B256SRB	16	25	25	+30%/-10%	2.7/2.3*	65/85*	60	27	50	15.00	2397	0.0253	3.47
SCCU30B356SRB	16	30	35	+30%/-10%	2.7/2.3*	65/85*	70	20	40	19.69	2514	0.0354	4.07
SCCT47B406SRB	12.5	47	40	+30%/-10%	2.7/2.3*	65/85*	75	19	29	25.00	4022	0.0405	5.40
SCCV40B506SRB	18	40	50	+30%/-10%	2.7/2.3*	65/85*	75	18	20	33.75	3365	0.0506	3.89
SCCV60B107SRB	18	60	100	+30%/-10%	2.7/2.3*	65/85*	260	15	18	48.21	2430	0.1013	5.06
<b>Solder Pin Lead</b>													
SCCW45B107SSB	22	45	100	+30%/-10%	2.7/2.3*	65/85*	260	8	12	61.36	3391	0.1013	4.71
SCCX50B207SSB	30	50	200	+30%/-10%	2.7/2.3*	65/85*	600	6	9	96.43	2461	0.2025	5.13
SCCY62B307SSB	35	62	300	+30%/-10%	2.7/2.3*	65/85*	650	6	9	109.46	1262	0.3038	3.94
SCCY68B407SSB	35	68	400	+30%/-10%	2.7/2.3*	65/85*	1000	4	5	180.00	2046	0.4050	4.74
<b>Cylindrical Lug Lead</b>													
SCCZ1EB308SCB	60	138	3000	+30%/-10%	2.7/2.3*	65/85*	5200	0.2	0.29	2165.78	6033	3.0375	6.08
<b>Cylindrical Screw Lead</b>													
SCCZ1EB308SWB	60	138	3000	+30%/-10%	2.7/2.3*	65/85*	5200	0.2	0.29	2165.78	6033	3.0375	6.08

\*with appropriate voltage derating operating temperature can be extended to 85°C

### QUALIFICATION TEST SUMMARY

Test	Test Method	Parameter	Limits
Life Cycle	Capacitors are cycled between rated voltage and half-rated voltage under constant current at +25°C for 500,000 cycles	Capacitance Change ESR Appearance	≤30% of initial spec value ≤2 times initial spec value No remarkable defects
High Temperature Load Life	Temperature: +65°C Voltage: Rated Voltage Test Duration: 2,000 hours	Capacitance Change ESR Appearance	≤30% of initial spec value ≤2 times initial spec value No remarkable defects
Storage Temperature Characteristics	Storage Duration: 2 years No Load Temperature: +35°C	Capacitance Change ESR Appearance	≤30% of initial spec value ≤2 times initial spec value No remarkable defects
Vibration Resistance	Amplitude: 1.5mm Frequency: 10 ~ 55Hz Direction: X, Y, Z for 2 hours each	Capacitance Change ESR Appearance	≤30% of initial spec value ≤2 times initial spec value No remarkable defects
Humidity	Voltage: Rated Voltage RH: 90% Temperature: +60°C Test Duration: 1,500 hours	Capacitance Change ESR Appearance	≤30% of initial spec value ≤2 times initial spec value No remarkable defects

### QUALITY AND RELIABILITY

#### Capacitance vs. Temperature

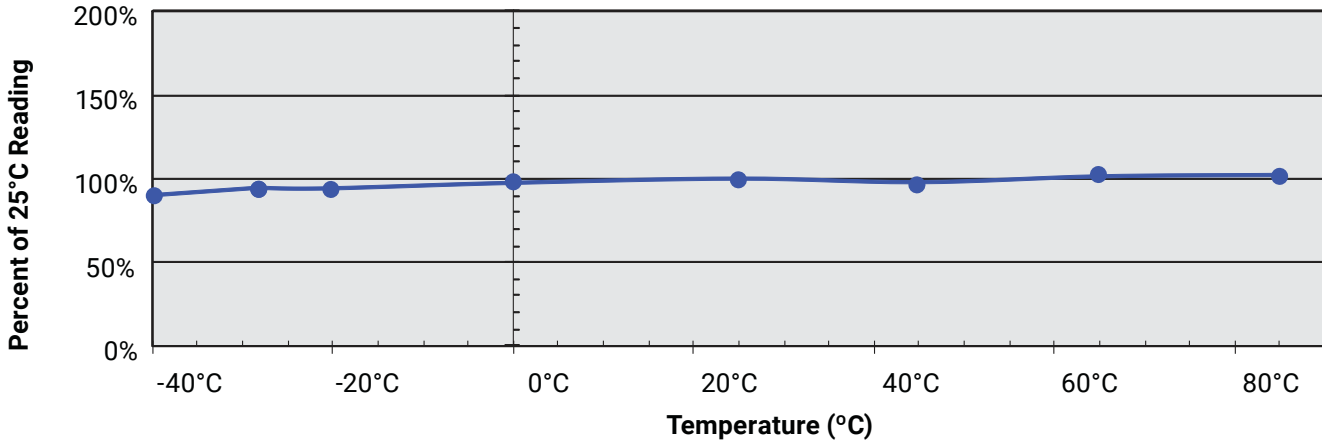

#### Leakage Current vs. Temperature

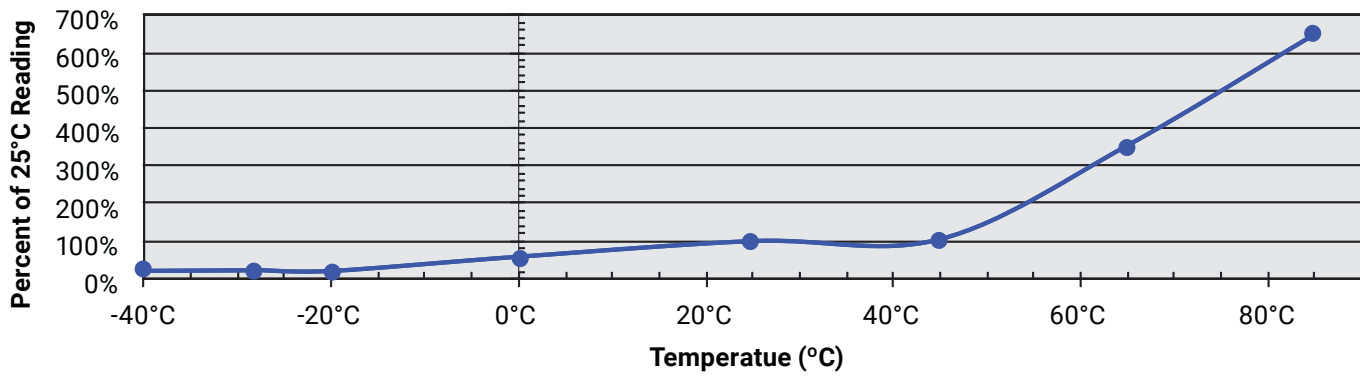

#### Equivalent Series Resistance vs. Temperature

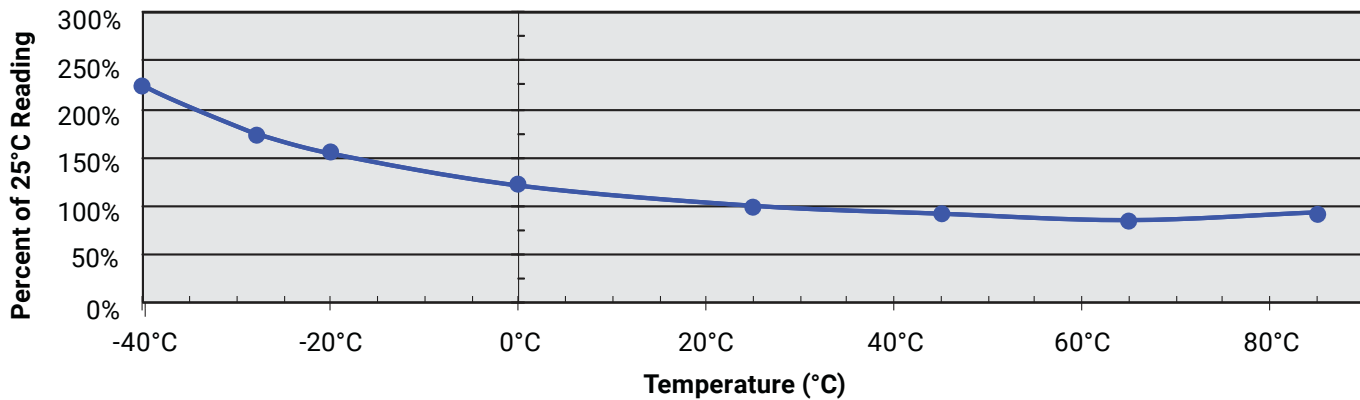

# SCC Series

## High Capacitance Cylindrical SuperCapacitors



### MECHANICAL SPECIFICATIONS

#### Radial Lead Type 1F – 100F

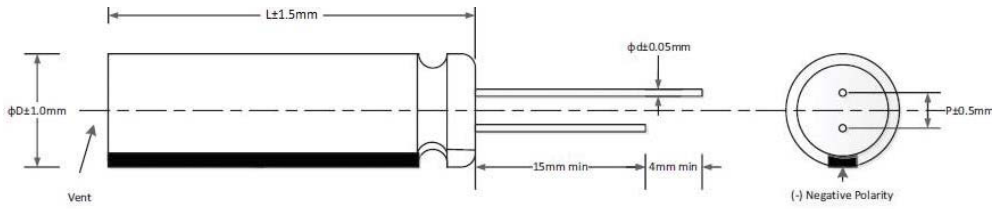

D (mm)	P (mm)	d (mm)
6.3	2.3	0.6
8	3.5	0.6
10	5.0	0.6
12.5	5.5	0.6
16	7.5	0.8
18	8	0.8

#### Solder Pin Type 2 pin 100F, 200F Part

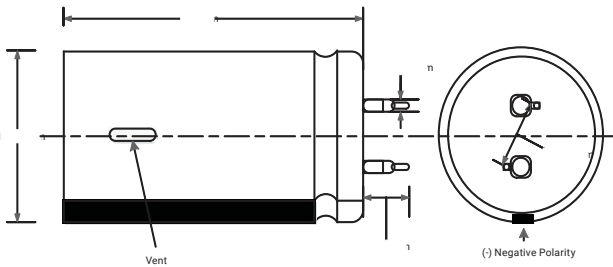

#### Solder Pin Type 4 pin 300F, 400F Part

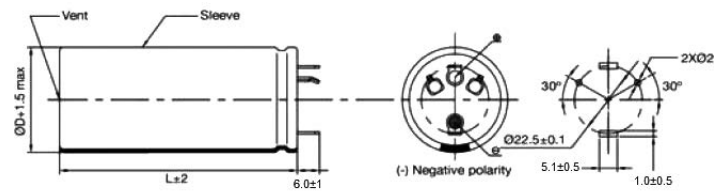

#### Cylindrical Lug Type 3000F Part

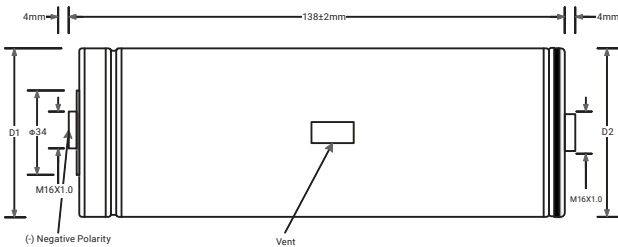

#### Radial Bent Lead Type

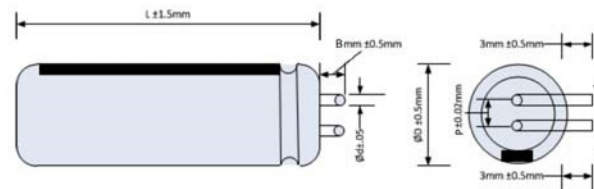

Style	B (mm)
A1	4
C1	2

#### Cylindrical Screw Type 3000F Part

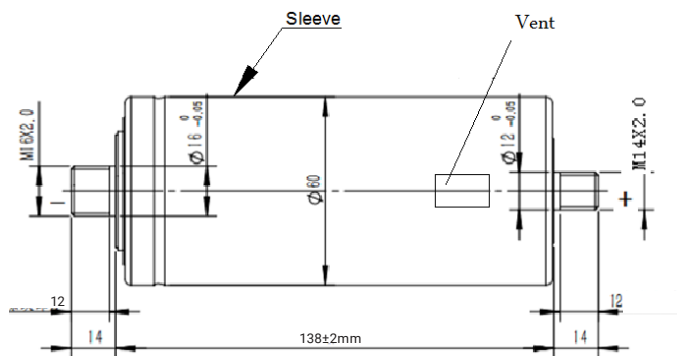

### SOLDERING RECOMMENDATIONS

When soldering SuperCapacitors to a PCB, the temperature & time that the body of the SuperCapacitor sees during soldering can have a negative effect on performance. We advise following these guidelines:

- Do not immerse the SuperCapacitors in solder. Only the leads should come in contact with the solder.
- Ensure that the body of the SuperCapacitor is never in contact with the molten solder, the PCB or other components during soldering.
- Excessive temperatures or excessive temperature cycling during soldering may cause the safety vent to burst or the case to shrink or crack, potentially damaging the PCB or other components, and significantly reduce the life of the capacitor.

#### HAND SOLDERING

Keep distance between the SuperCapacitor body and the tip of the soldering iron and the tip should never touch the body of the capacitor. Contact between SuperCapacitor body and soldering iron will cause extensive damage to the SuperCapacitor, and change its electrical properties. It is recommended that the soldering iron temperature should be less than 350°C, and contact time should be limited to less than 4 seconds. Too much exposure to terminal heat during soldering can cause heat to transfer to the body of the SuperCapacitor, potentially damaging the electrical properties of the SuperCapacitor.

#### WAVE SOLDERING

Only use wave soldering on Radial type SuperCapacitors. The PCB should be preheated only from the bottom and for less than 60 seconds, with temperature at, or below, 100°C on the top side of the board for PCBs equal to or greater than 0.8 mm thick.

Solder Temperature (°C)	Suggested Solder Time (s)	Maximum Solder Time (s)
220	7	9
240	7	9
250	5	7
260	3	5

#### REFLOW SOLDERING

Infrared or conveyor over reflow techniques can be used on these SuperCapacitors. Do not use a traditional reflow oven without clear rated reflow temperature for SuperCapacitors.

### TEST METHODS

#### IEC CAPACITANCE TEST METHOD

- Capacitance is measured using a Keithley 2400 or 2602 Meter
- Procedure
  - Charge Capacitor to Rated Voltage at room temperature
  - Disconnect parts from voltage to remove charging effects
  - Discharge cells with a constant current  $I$  determined by  $4 * C * VR$
  - Noting  $V_1, t_1, V_2, t_2$  and performing the calculation for  $C$

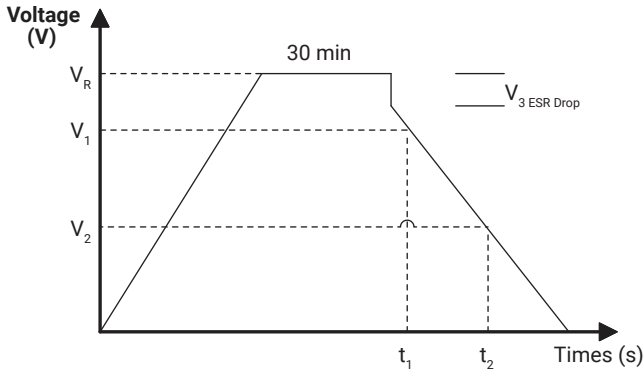

$I$  – Discharge Current [mA],  $4 * C * VR$   $VR$  – Rated Voltage

$V_1$  – Initial Test Voltage, 80% of  $VR$

$V_2$  – Final Test Voltage, 40% of  $VR$

$t_1$  – Initial Test time

$t_2$  – Final Test time

$$C = I * (t_2 - t_1) / (V_1 - V_2)$$

#### DCL MEASUREMENT @ 25°C

- DCL is measured using a Multimeter with high internal impedance across a resistor
  - Charge Capacitor to Rated Voltage at room temperature for 72 Hours
  - Disconnect parts from Voltage by opening switch 1 (Stabilize for 10 Min)
  - Measure Voltage across a known Valued Resistor (1K Ohm)
  - Calculate  $DCL = V/R$

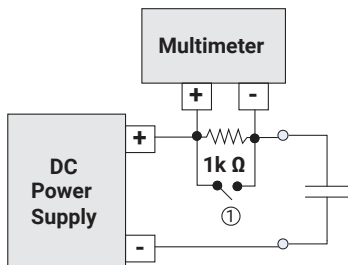

#### INITIAL ESR MEASUREMENT @ 25°C

- Using an Agilent 4263B LCR Meter and a Kelvin connection
  - Measure at frequency of 1000 Hz
  - Measurement Voltage of 10mV

#### DC ESR MEASUREMENT

- Six steps capacity and ESRDC Test Method is used as illustrated in the figure right.

- Tests are carried out by charging and discharging the capacitor for two cycles at rated voltage and half rated voltage

- $C = (CDC1 + CDC2) / 2$
- $ESRDC = (ESRDC1 + ESRDC2) / 2$
- Where:  $CDC1 = I_2 * (t_5 - t_4) / (V_3 - V_4)$
- $CDC2 = I_2 * (t_{11} - t_{10}) / (V_9 - V_{10})$
- $ESRDC1 = (V_5 - V_4) / I_2$
- $ESRDC2 = (V_{11} - V_{10}) / I_2$
- $I_1 = I_2 = 75mA/F$

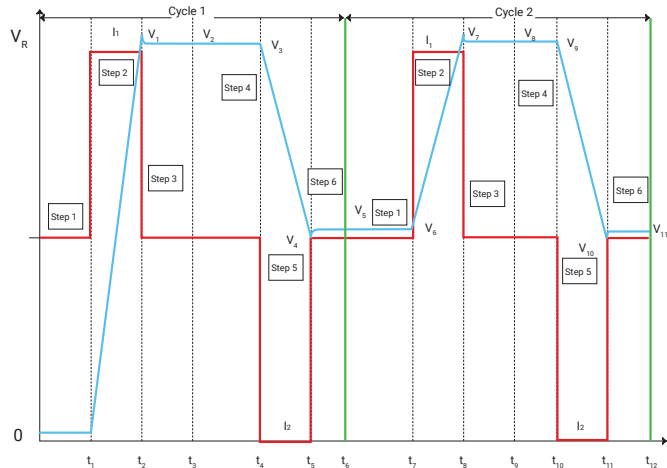

#### MAXIMUM OPERATING CURRENT

- This is the maximum current when capacitor temperature rise of the capacitor during its operation is less than 15°C

#### MAXIMUM PEAK CURRENT

- This is the maximum current in less than 1 sec

#### WATT DENSITY

- Watt Density =  $(0.12 * V^2 / RDC) / \text{mass}$

#### ENERGY DENSITY

- Energy density =  $(\frac{1}{2} CV^2) / (3600 * \text{mass})$

### POLARITY / REVERSE VOLTAGE

For product consistency and optimum performance, it is recommended that the capacitor be connected with polarity indicated. Reversing polarity could result in permanent damage to the circuit including much higher leakage current for a short duration of time and the life time of the supercapacitors will be reduced.

### LIFE TIME AND TEMPERATURE PERFORMANCE

The life of a SuperCapacitor is impacted by a combination of operating voltage and the operating temperature according to the following equation:

time to failure,  $t \propto V^n \cdot \exp(-Q / k \cdot T)$  .....(1) where V is the voltage of operation, Q is the activation energy in electron volts (eV), k is the Boltzmann's constant in eV and T is the operating temperature in °K (where K is in degrees Kelvin). Typical values for the voltage exponent, n, is between 2.5 - 3.5, and Q is between 1.0 - 1.2 eV in the normal operating temperature range of 40° to 65°C.

The industry standard for SuperCapacitor end of life is when the equivalent series resistance, ESR, increases to 200% of the original value and the capacitance drops by 30%. Typically a super-capacitance shows an initial change in the ESR value and then levels off. If the capacitors are exposed to excessive temperatures the ESR will show a continuous degradation. In the extreme case, if the temperatures or voltages are substantially higher, than the rated voltage, this will lead to cell leakage or gas leakage and the product will show a faster change in the ESR which may increase to many times the original value.

**Expected Lifetime at Various Voltages  
SCC Series, 2.7V Rated**

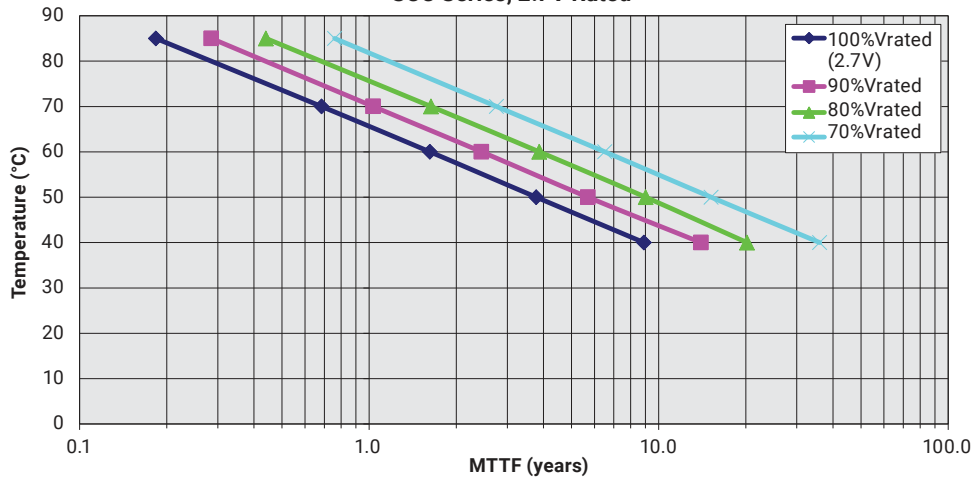

**Expected Lifetime at Various Voltages  
SCC Series, 2.3V Rated**

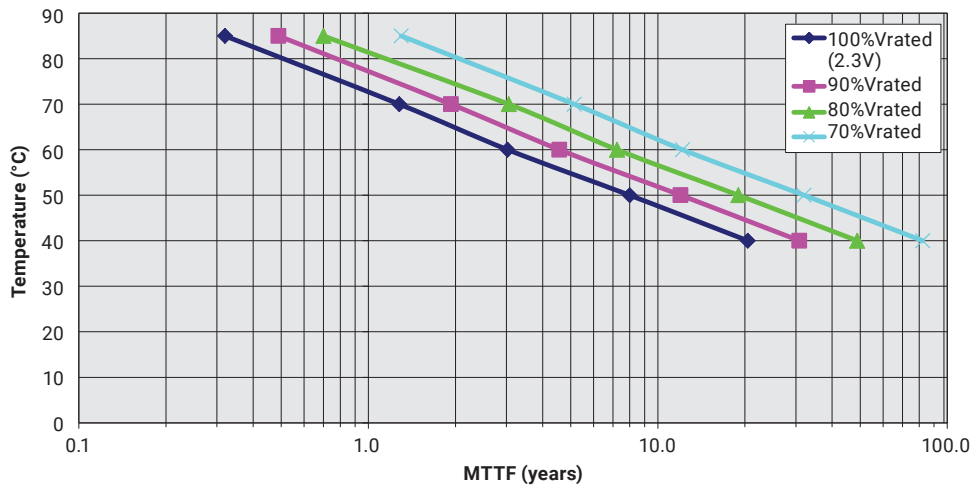

### SAFETY RECOMMENDATIONS

#### WARNINGS

- To Avoid Short Circuit, after usage or test, SuperCapacitor voltage needs to discharge to  $\leq 0.1V$
- Do not Apply Overvoltage, Reverse Charge, Burn or Heat Higher than  $150^{\circ}C$ , explosion-proof valve may break open
- Do not Press, Damage or disassemble the SuperCapacitor, housing could heat to high temperature causing Burns
- If you observe Overheating or Burning Smell from the capacitor disconnect Power immediately, and do not touch

#### EMERGENCY APPLICATIONS

- If Housing is Leaking:
  - Skin Contact: Use soap and water thoroughly to wash the area of the skin
  - Eye Contact: Flush with flowing water or saline, and immediately seek medical treatment
  - Ingestion: Immediately wash with water and seek medical treatment

#### TRANSPORTATION

Not subjected to US DOT or IATA regulations  
UN3499, <10Wh, Non-Hazardous Goods  
International shipping description –  
"Electronic Products – Capacitor"

#### REGULATORY

- UL 810A
- RoHS Compliant
- Reach Compliant / Halogen Free

#### STORAGE

- Capacitors may be stored within the operating temperature range of the capacitor
- Lower storage temperature is preferred as it extends the shelf life of the capacitor
- Do Not Store the SuperCapacitors in the following Environments
  - High Temperature / High Humidity environments  $>40^{\circ}C$  / 70% RH
  - Direct Sunlight
  - In direct contact with water, salt oil or other chemicals
  - In direct contact with corrosive materials, acids, alkalis, or toxic gases
  - Dusty environment
  - In environment with shock and vibration conditions

Licensed by CAP-XX