

**Actuator/Sensor cable, PUR**  
**Connection cable**  
**WKC5T-5/TXG**

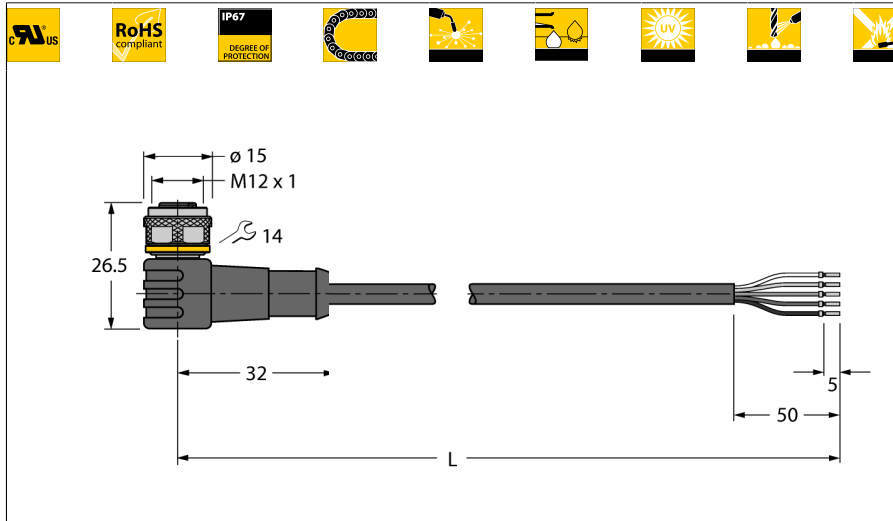

- Female M12, angled, 4-pin + PE
- Sheath material: PUR
- Sheath color: grey
- Qualified for drag chain use
- Resistant to weld splatter
- Resistant to chemicals, UV radiation and oils
- Flame retardant
- Free from halogen, silicone, PVC and LABS
- Particularly resistant to abrasion
- Approval: cULus
- RoHS conform
- Protection class IP67
- Cable length: 5.0 m

<b>Type designation</b>	WKC5T-5/TXG
Ident no.	6629706

<b>Connector A side</b>	Female connector, M12 ⚡ 1, Angled
Number of pins	4+PE
Contacts	Brass, CuZn, Gold-plated
Contact carriers	Plastic, TPU, Black
Grip	Plastic, TPU, Black
Coupling nut/screw	Brass, CuZn, Nickel-plated
Seal	Plastic, FPM/FKM
Protection class	IP67, A + B side screwed together
Mechanical lifespan	> 100 Mating cycles
Pollution degree	3
Tightening torque	0.8 ... 1 Nm (observe max. torque of counter piece!)

<b>General data</b>	
Cable diameter	5.5 ± 0.20mm
Cable length	5 m
Cable quality	PUR
Cable color	Gray
Core insulation	PP
Core colors	BN, WH, BU, BK, GNYE
Core cross-section	5x0.34mm <sup>2</sup>
Arrangement of strands	42x0.1 mm

<b>Electrical features at +20 °C</b>	
Current	4 A
Rated voltage	60 V
Insulation resistance	> 30.5 MΩ/km
Test voltage	2000 V
Forward resistance	max. 57 Ω/km

**Cable Cross-section**

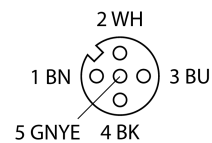
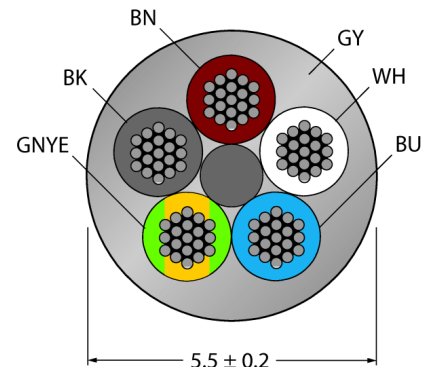

**General information**

Drawing depicts design version including hexagon coupling nut  
 (Production date after CW11/2016).

**Circuit Diagram**

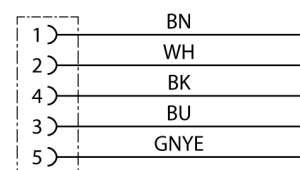

**Actuator/Sensor cable, PUR**  
**Connection cable**  
**WKC5T-5/TXG**

**TURCK**

Industrial  
Automation

---

**Mechanical and chemical properties**

Max. tensile strength (static)	≤ 50 N/mm <sup>2</sup>
Max. tensile strength (dynamic)	≤ 20 N/mm <sup>2</sup>
Bending cycles	> 5 mil.
Bending radius (stationary laying)	> 5 x Ø
Bending radius (flexible use)	> 10 x Ø
Admissible acceleration	max. 5 m/s <sup>2</sup>
Admissible travel path, horizontal	5 m (at 5 m/s <sup>2</sup> )
Admissible travel path, vertical	2 m (at 5 m/s <sup>2</sup> )
Admissible traversing speed	3.3 m/s
Torsional stress	± 180 °/m
Ambient temperature	
Stationary	-50...+80°C
In motion	-25...+80°C
Drag chain operation	-25...+60°C

**Actuator/Sensor cable, PUR**  
**Connection cable**  
**WKC5T-5/TXG**

**TURCK**

Industrial  
Automation

**Accessories**

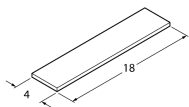
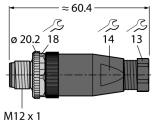
Type code	Ident no.	Description	
Torque-Wrench-Set-AS	6936170	Torque wrench set; handles with adjustable torque 0.4-1.0 Nm, torque wrench for M8 (SW9), fork wrench for M12 (SW 14)	
BLANK-LABEL-FOR-CORDSETS-TEL-TXL	6936206	Label for TEL and TXL cables, length: 18 mm, height: 4 mm, material: polycarbonate (PC), color: white, halogen-free and flame-retardant	
BS8151-0	6904611	Field-wireable male connector, M12 $\leftarrow$ 1, straight, 5-pin, screw terminal connection, cable feedthrough 4.0 to 6.0 mm, core cross-section/terminal capacity 0.14 to 0.75 mm <sup>2</sup> , plastic housing, metal nut	
BS8251-0	6904612	Field-wireable male connector, M12 $\leftarrow$ 1, angled, 5-pin, screw terminal connection, cable feedthrough 4.0 to 6.0 mm, core cross-section/terminal capacity 0.14 to 0.75 mm <sup>2</sup> , plastic housing, metal nut	