



Title	<i>Reference Design Report for a 9.6 W Non-Isolated Buck Converter Using LinkSwitch™-TN2 LNK3209D</i>
Specification	85 VAC – 265 VAC Input; 12 V, 800 mA Output
Application	Small Appliance
Author	Applications Engineering Department
Document Number	RDR-723
Date	June 9, 2022
Revision	1.0

Summary and Features

- 725 V maximum drain voltage
- Highly integrated solution
- Lowest possible component count
- No optocoupler required for regulation
- Thermal overload protection with automatic recovery
- Start-up soft start function
- Capable to operate at full load up to 50 °C ambient
- >80% efficiency at full load
- <±5% load regulation

PATENT INFORMATION

The products and applications illustrated herein (including transformer construction and circuits external to the products) may be covered by one or more U.S. and foreign patents, or potentially by pending U.S. and foreign patent applications assigned to Power Integrations. A complete list of Power Integrations' patents may be found at www.power.com. Power Integrations grants its customers a license under certain patent rights as set forth at <https://www.power.com/company/intellectual-property-licensing/>.

Power Integrations

5245 Hellyer Avenue, San Jose, CA 95138 USA.
Tel: +1 408 414 9200 Fax: +1 408 414 9201
www.power.com

10.2.1	Ripple Measurement Technique.....	36
10.2.2	Measurement Results	37
10.2.3	Ripple Voltage Waveforms	38
10.3	Transient Response	43
11	Conducted EMI	45
11.1	800 mA Resistive Load, Floating Output (QPK / AV).....	45
11.1.1	115 VAC.....	45
11.1.2	230 VAC.....	46
12	Lightning Surge	47
12.1	Differential Mode Test.....	47
12.1.1	1000 V 90° Differential Mode Surge.....	47
13	Revision History	48

Important Note:

Although this board is designed to satisfy safety isolation requirements, the engineering prototype has not been agency approved. Therefore, all testing should be performed using an isolation transformer to provide the AC input to the prototype board.



1 Introduction

This engineering prototype report describes a non-isolated 12 V, 800 mA power supply utilizing a LNK3209D/G IC from Power Integrations. The report contains the power supply specification, schematic, bill-of-materials, printed circuit layout, and performance data.

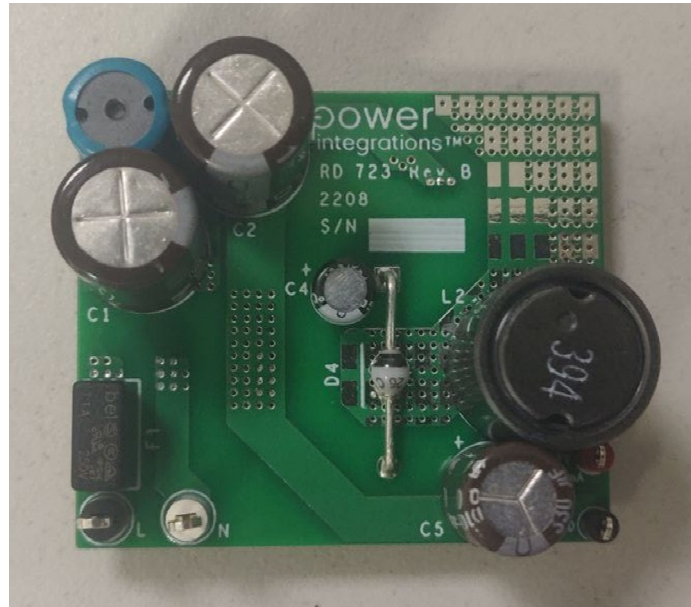

Figure 1 – Populated Circuit Board Photograph, Top.

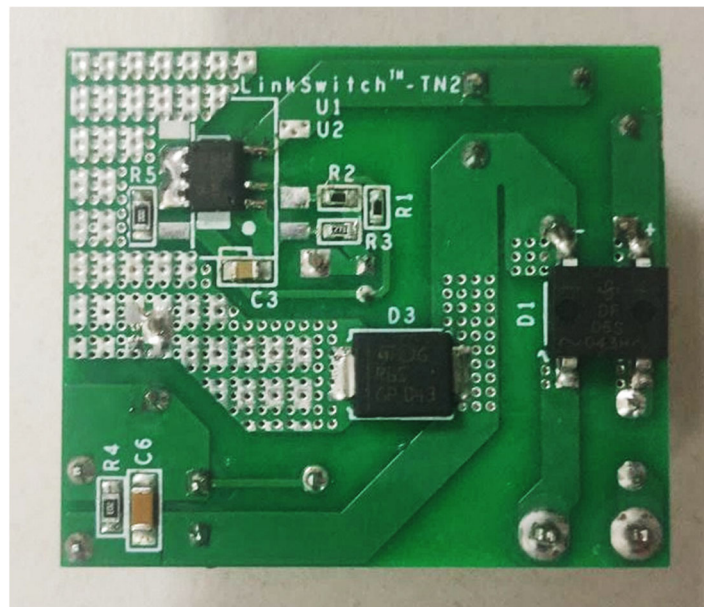

Figure 2 – Populated Circuit Board Photograph, Bottom.

2 Power Supply Specification

The table below represents the minimum acceptable performance of the design. Actual performance is listed in the results section.

Description	Symbol	Min	Typ	Max	Units	Comment	
Input							
Voltage	V_{IN}	85		265	VAC	2 Wire – no P.E.	
Frequency	f_{LINE}	47	50/60	64	Hz		
No-load Input Power (230 VAC)				<50	mW		
Output							
Output Voltage	V_{OUT}		12		V	±5%. 20 MHz Bandwidth.	
Output Ripple Voltage	V_{RIPPLE}			150	mV		
Output Current	I_{OUT}		800		mA	System Load upon Insertion.	
Min. Output Current	$I_{OUT,MIN}$		80		mA		
Total Output Power							
Continuous Output Power	P_{OUT}		9.6		W		
Efficiency							
Full Load (115 VAC)	η	81			%	Measured at the End of PCB. 25 °C.	
Full Load (230 VAC)		80			%		
Ave Efficiency (Nominal)		80			%		
Environmental							
Conducted EMI		Meets CISPR22B / EN55022B					1.2/50 μ s surge, IEC 61000-4-5, Series Impedance: Differential Mode: 2 Ω .
Line Surge Differential Mode (L1-L2)			1		kV		
Ambient Temperature	T_{AMB}	0		50	°C	Free Convection, Sea Level.	



3 Schematic

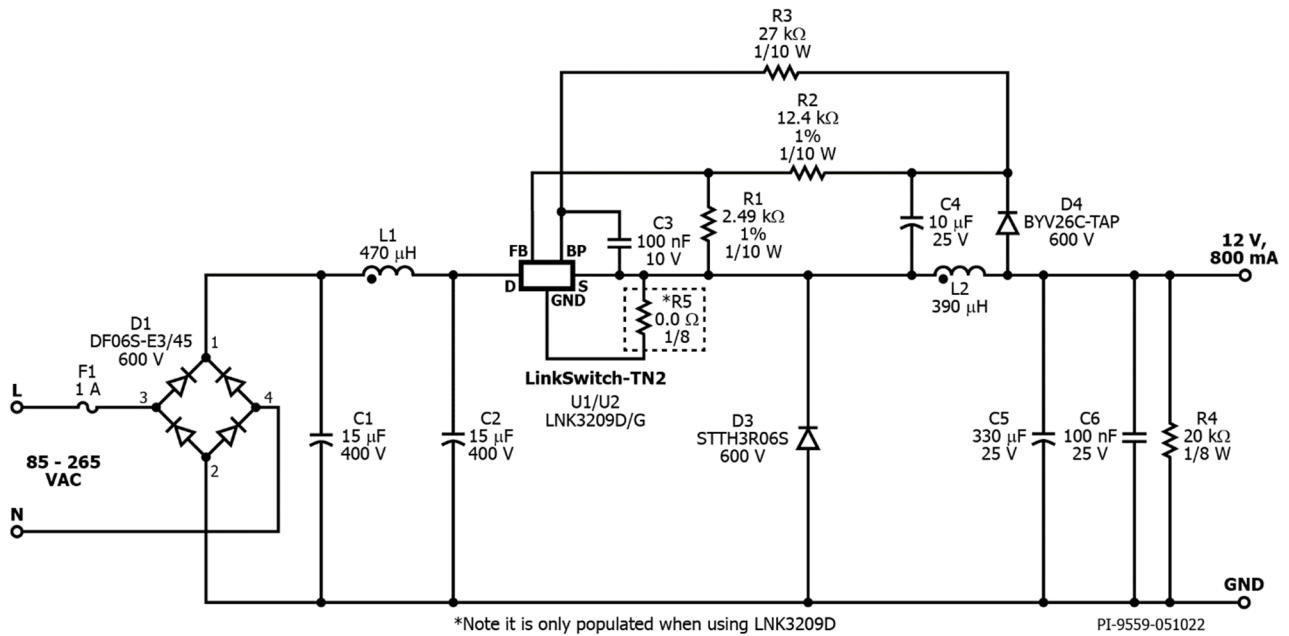

Figure 3 – Schematic.

Note:

1. U1 can be implemented as LNK3209D or U2 for LNK3209G.
2. R5 is only populated when using LNK3209D as U1.

4 Circuit Description

The schematic in Figure 3 shows an implementation of a buck converter using LNK3209D/G. The circuit provides a non-isolated 12 V, 800 mA continuous output.

4.1 *Input EMI Filtering*

The input stage is comprised of fuse F1, bridge rectifier diode D1, and an EMI suppression circuit in a pi filter configuration with C1, inductor L1, and C2.

4.2 *LinkSwitch-TN2*

The LinkSwitch-TN2 combines a high-voltage power MOSFET and the power supply controller into a monolithic IC.

When AC is first applied, an internal current source connected to the DRAIN (D) pin charges C3 to power the controller inside the IC. When the output voltage is established, the device controller will now be powered from the output via a feedback diode D4 and current limiting resistor R3 to minimize losses.

The control scheme used is similar to the ON/OFF control used in TinySwitch™. The LinkSwitch-TN2 family of controllers work on the principle of ON-OFF control in which output regulation is achieved by skipping cycles in response to a signal applied to the FEEDBACK (FB) pin. Current into the FB pin greater than 49 μA will inhibit the switching of the internal power MOSFET, while current below this allows switching cycles to occur. During full load operation, only a few switching cycles will be skipped (disabled), which results in a high effective switching frequency. As the load is reduced, some switching cycles are skipped reducing the effective switching frequency.

When using LNK3209G, pin 8 GROUND (GND) is used as dedicated ground reference for BYPASS (BP/M) and FB pins. This is to minimize the coupling of noise from the SOURCE (S) pin to the BP/M and FB circuit. Resistor R5 is populated only when using LNK3209D to connect the control circuit to the S pin.

4.3 *Output Rectification*

When the internal power MOSFET is on, current ramps through L2 until the internal current limit is reached. This then turns off the internal power MOSFET and allows the inductor current to freewheel via diode D3 for the remainder of the switching cycle. For this design, an ultrafast diode (t_{RR} of 30 ns) is selected for D3 due to continuous operation at full load. Capacitor C5 should be selected to have an adequate ripple current rating (low ESR type). Capacitor C6 provides the filtering of the high frequency output voltage ripple.

4.4 *Output Feedback*

During the power MOSFET off-time, capacitor C4 is charged to the output voltage via D4. The voltage developed across C4 tracks the output voltage. This voltage is used to provide feedback to the IC via the resistor divider formed by resistors R1 and R2. The values of R1

and R2 are selected such that at the nominal output voltage, the voltage on the FB pin is 2 V. The FEEDBACK (FB) pin is then sampled by the controller inside U1 during each switching cycle.



5 PCB Layout

Layers: Two (2)
 Board Materials: FR4
 Board Thickness: 1.6 mm
 Copper Weight: 2 oz

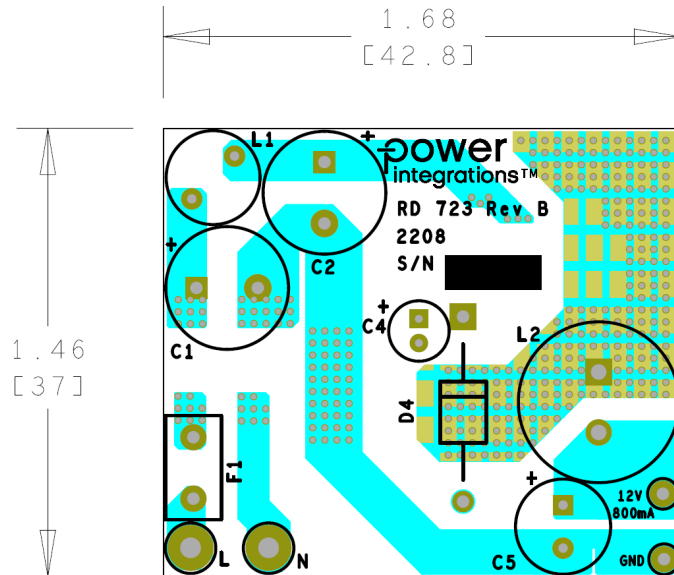

Figure 4 – Printed Circuit Layout, Top (1.46" [37 mm] L x 1.68" [42.8 mm] W).

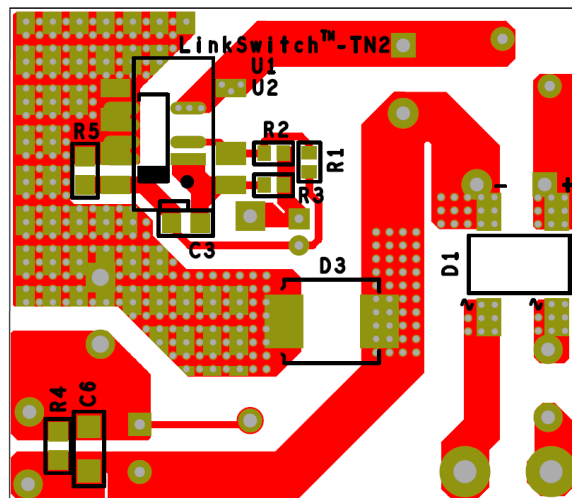

Figure 5 – Printed Circuit Layout, Bottom.

6 Bill of Materials

6.1 Main BOM

Item	Qty	Ref Des	Description	Mfg Part Number	Mfg
1	2	C1 C2	15 μ F, 400 V, Electrolytic, (10 x 16)	UVC2G150MPD	Nichicon
2	1	C3	100 nF, 0.1 μ F, 10 V, Ceramic, X7R, 0805	0805ZC104MAT2A	AVX
3	1	C4	10 μ F, 25 V, Aluminum Electrolytic, Radial, Can - 1000 Hrs @ 85 $^{\circ}$ C, (5 x 5) ls2.5 mm	ECE-A1EKS100I	Panasonic
4	1	C5	330 μ F, 25 V, Electrolytic, Very Low ESR, 56 m Ω , (8 x 15)	EKZE250ELL331MH15D	Nippon Chemi-Con
5	1	C6	100 nF, 25 V, Ceramic, X7R, 1206	C1206F104K3RACTU	Kemet
6	1	D1	600 V, 1 A, Bridge Rectifier, SMD, DFS	DF06S-E3/45	Vishay
7	1	D3	600 V, 3 A, SMC, DO-214AB	STTH3R06S	ST Micro
8	1	D4	600 V, 1 A, Ultrafast Recovery, 30 ns, SOD57	BYV26C-TAP	Vishay
9	1	F1	1 A, 250 V, Slow, Long Time Lag, RST 1	RST 1	Belfuse
10	1	L1	470 μ H, 0.49 A	SBC3-471-491	Token
11	1	L2	Fixed Inductors, RFS1113, 390 μ H, 10%, 0.317 Ω , Radial, 13.3 mm Diam, 16 mm Length	RFS1317-394KL	Coilcraft
12	1	R1	RES, 2.49 k Ω , 1%, 1/10 W, Thick Film, 0603	ERJ-3EKF2491V	Panasonic
13	1	R2	RES, 12.4 k Ω , 1%, 1/10 W, Thick Film, 0603	ERJ-3EKF1242V	Panasonic
14	1	R3	RES, 27 k Ω , 5%, 1/10 W, Thick Film, 0603	ERJ-3GEYJ273V	Panasonic
15	1	R4	RES, 20 k Ω , 5%, 1/8 W, Thick Film, 0805	ERJ-6GEYJ203V	Panasonic
16	1	R5*	RES, 0 Ω , 5%, 1/8 W, Thick Film, 0805	RMCF0805ZT0R00	Stackpole
17	1	U1/ U2	LinkSwitch-TN2	LNK3209D/G	Power Integrations

* R5 will be populated only if LNK3209D is used.

6.2 Miscellaneous Parts

Item	Qty	Ref Des	Description	Mfg Part Number	Mfg
1	1	L	Test Point, WHT, THRU-HOLE MOUNT	Keystone	5012
2	1	N	Test Point, BLK, THRU-HOLE MOUNT	Keystone	5011
3	1	12V	Test Point, RED, Miniature THRU-HOLE MOUNT	Keystone	5000
4	1	GND	Test Point, BLK, Miniature THRU-HOLE MOUNT	Keystone	5001



7 Design Spreadsheet

1	ACDC_LinkSwitchTN2-Buck_092421; Rev.1.5; Copyright Power Integrations 2021	INPUT	INFO	OUTPUT	UNIT	ACDC_LinkSwitchTN2 Buck
2	ENTER APPLICATION VARIABLES					
3	LINE VOLTAGE RANGE			Universal		AC line voltage range
4	VACMIN	85.00		85.00	V	Minimum AC line voltage
5	VACTYP			115.00	V	Typical AC line voltage
6	VACMAX	265.00		265.00	V	Maximum AC line voltage
7	fL			60.00	Hz	AC mains frequency
8	LINE RECTIFICATION TYPE	F		F		Select 'F'ull wave rectification or 'H'alf wave rectification
9	VOUT	12.00		12.00	V	Output voltage
10	IOUT	0.800		0.800	A	Average output current
11	EFFICIENCY_ESTIMATED			0.80		Efficiency estimate at output terminals
12	EFFICIENCY_CALCULATED			0.74		Calculated efficiency based on real components and operating point
13	POUT			9.60	W	Continuous Output Power
14	CIN	30.00		30.00	uF	Input capacitor
15	VMIN			97.0	V	Valley of the rectified input voltage
16	VMAX			374.8	V	Peak of the rectified maximum input AC voltage
17	T_AMBIENT			50	degC	Operating ambient temperature in degrees celcius
18	INPUT STAGE RESISTANCE			10	Ohms	Input stage resistance in ohms (includes fuse, thermistor, filtering components)
19	PLOSS_INPUTSTAGE			0.199	W	Input stage losses estimate
23	ENTER LINKSWITCH-TN2 VARIABLES					
24	OPERATION MODE			MCM		Mostly continuous mode of operation
25	CURRENT LIMIT MODE	STD		STD		Choose 'RED' for reduced current limit or 'STD' for standard current limit
26	PACKAGE	SO-8C		SO-8C		Select the device package
27	DEVICE SERIES	Auto		LNK32X9		Generic LinkSwitch-TN2 device
28	DEVICE CODE			LNK3209D		Required LinkSwitch-TN2 device
29	ILIMITMIN			1.200	A	Minimum current limit of the device
30	ILIMITTYP			1.300	A	Typical current limit of the device
31	ILIMITMAX			1.400	A	Maximum current limit of the device
32	RDSON			3.20	ohms	MOSFET's on-time drain to source resistance at 100degC
33	FSMIN			62000	Hz	Minimum switching frequency
34	FSTYP			66000	Hz	Typical switching frequency
35	FSMAX			70000	Hz	Maximum switching frequency
36	VDSON			2.00	V	MOSFET on-time drain to source voltage estimate
37	DUTY			0.13		Maximum duty cycle
38	TIME_ON			2.141	us	MOSFET conduction time at the minimum line voltage
39	TIME_ON_MIN			1.299	us	MOSFET conduction time at the maximum line voltage
40	KP_TRANSIENT		Info	0.119		Transient KP less than 0.2 may lead to a leading edge SOA trigger
41	IRMS_MOSFET			0.303	A	MOSFET RMS current
42	PLOSS_MOSFET			0.887	W	Primary MOSFET loss estimate
46	BUCK INDUCTOR PARAMETERS					
47	INDUCTANCE_MIN			351	uH	Minimum design inductance required for power delivery
48	INDUCTANCE_TYP	390		390	uH	Typical design inductance required for power delivery
49	INDUCTANCE_MAX			429	uH	Maximum design inductance required for power delivery
50	TOLERANCE_INDUCTANCE			10	%	Tolerance of the design inductance
51	DC RESISTANCE OF INDUCTOR			2.0	ohms	DC resistance of the buck inductor



52	FACTOR_LOSS			0.900		Factor that accounts for off-state power loss to be supplied by inductor
53	IRMS_INDUCTOR			0.833	A	Inductor RMS current
54	PLOSS_INDUCTOR			1.387	W	Inductor losses
58	FREEWHEELING DIODE PARAMETERS					
59	VF_FREEWHEELING			0.70	V	Forward voltage drop of the freewheeling diode
60	PIV			468	V	Peak inverse voltage of the freewheeling diode
61	IRMS_DIODE			0.775	A	Diode RMS current
62	TRR			30	ns	Required reverse recovery time of the selected diode
63	PLOSS_DIODE			0.829	W	Freewheeling diode losses
64	RECOMMENDED DIODE			BYV26C	W	Recommended freewheeling diode
68	BIAS/FEEDBACK PARAMETERS					
69	VF_BIAS			0.70	V	Forward voltage drop of the bias diode
70	RBIAS			2490	Ohms	Bias resistor
71	CBP			0.1	uF	BP pin capacitor
72	RFB			11800	Ohms	Feedback resistor
73	CFB			10	uF	Feedback capacitor
74	C_SOFTSTART			1-10	uF	If the output voltage is greater than 12 V or total output and system capacitance is greater than 100 uF, a soft start capacitor between 1uF and 10 uF is recommended
75	PLOSS_FEEDBACK			0.010	W	Feedback section losses
79	OUTPUT CAPACITOR					
80	OUTPUT VOLTAGE RIPPLE			240	mV	Desired output voltage ripple
81	IRIPPLE_COUT			0.800	A	Output capacitor ripple current
82	ESR_COUT			300	mOhms	Maximum ESR of the output capacitor



8 Performance Data

All measurements performed at room temperature.

8.1 Efficiency vs. Line

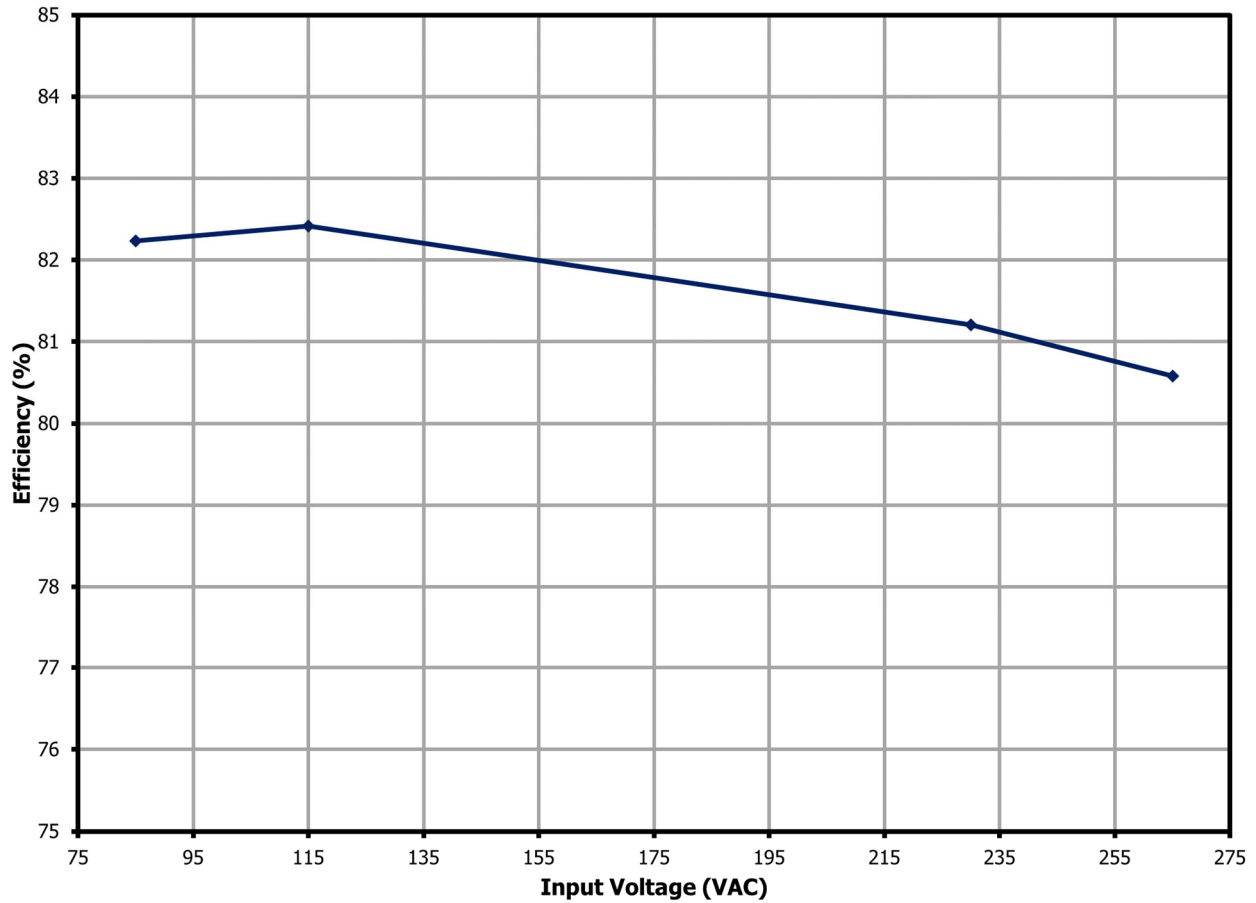

Figure 6 – Full Load (800 mA) Efficiency vs. Line Voltage, Room Temperature.

8.2 Efficiency vs. Load

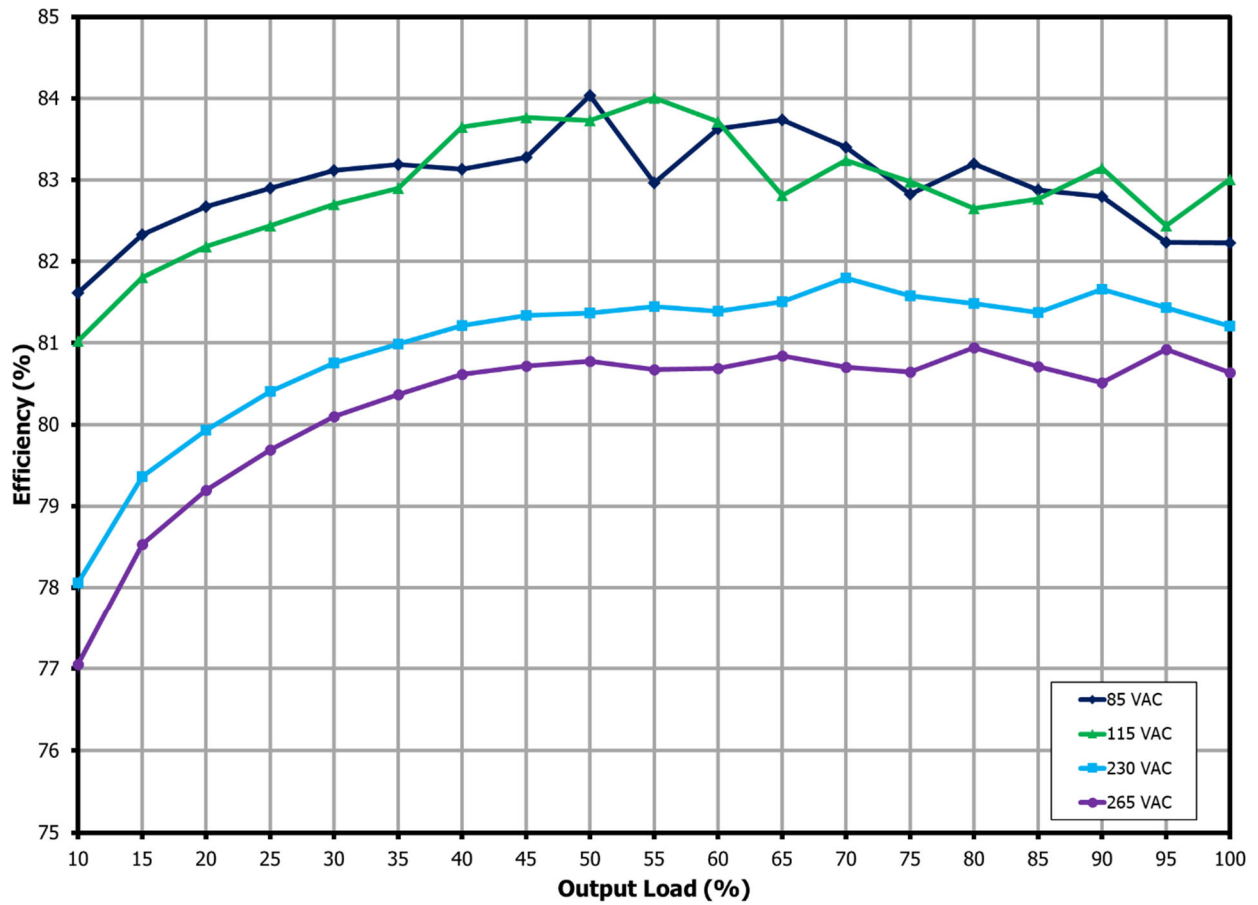

Figure 7 – Efficiency vs. Load, Room Temperature.

8.3 Average Efficiency

8.3.1 85 VAC / 60 Hz

Load (A)	V _{IN} (V _{RMS})	I _{IN} (mA _{RMS})	P _{IN} (W)	V _{OUT} at PCB (V _{DC})	I _{OUT} (mA _{DC})	P _{OUT} (W)	Efficiency at PCB (%)
100%	85	256.76	11.69	12.02	799.80	9.61	82.23
75%	85	202.72	8.72	12.04	599.80	7.23	82.83
50%	85	146.56	5.76	12.09	399.80	4.84	84.03
25%	85	84.33	2.93	12.14	199.69	2.42	82.90
						Average	83.00

8.3.2 115 VAC / 60 Hz

Load (A)	V _{IN} (V _{RMS})	I _{IN} (mA _{RMS})	P _{IN} (W)	V _{OUT} at PCB (V _{DC})	I _{OUT} (mA _{DC})	P _{OUT} (W)	Efficiency at PCB (%)
100%	115	213.51	11.57	12.01	799.80	9.61	83.00
75%	115	170.75	8.70	12.04	599.90	7.22	82.98
50%	115	123.85	5.77	12.09	399.80	4.83	83.73
25%	115	72.10	2.94	12.13	199.67	2.42	82.44
						Average	83.04

8.3.3 230 VAC / 50 Hz

Load (A)	V _{IN} (V _{RMS})	I _{IN} (mA _{RMS})	P _{IN} (W)	V _{OUT} at PCB (V _{DC})	I _{OUT} (mA _{DC})	P _{OUT} (W)	Efficiency at PCB (%)
100%	230	143.17	11.83	12.01	799.80	9.61	81.21
75%	230	115.73	8.85	12.04	599.80	7.22	81.58
50%	230	82.66	5.94	12.08	399.80	4.83	81.37
25%	230	45.69	3.01	12.12	199.69	2.42	80.40
						Average	81.14

8.3.4 265 VAC / 50 Hz

Load (A)	V _{IN} (V _{RMS})	I _{IN} (mA _{RMS})	P _{IN} (W)	V _{OUT} at PCB (V _{DC})	I _{OUT} (mA _{DC})	P _{OUT} (W)	Efficiency at PCB (%)
100%	265	136.19	11.91	12.01	799.80	9.60	80.64
75%	265	110.30	8.96	12.05	599.80	7.23	80.65
50%	265	75.60	5.97	12.07	399.80	4.83	80.78
25%	265	41.22	3.04	12.11	199.66	2.42	79.69
						Average	80.44

8.4 Standby Mode Efficiency

Test Condition: Soak at full load for 5 minutes and decrease load to standby mode for 5 minutes for each line step.

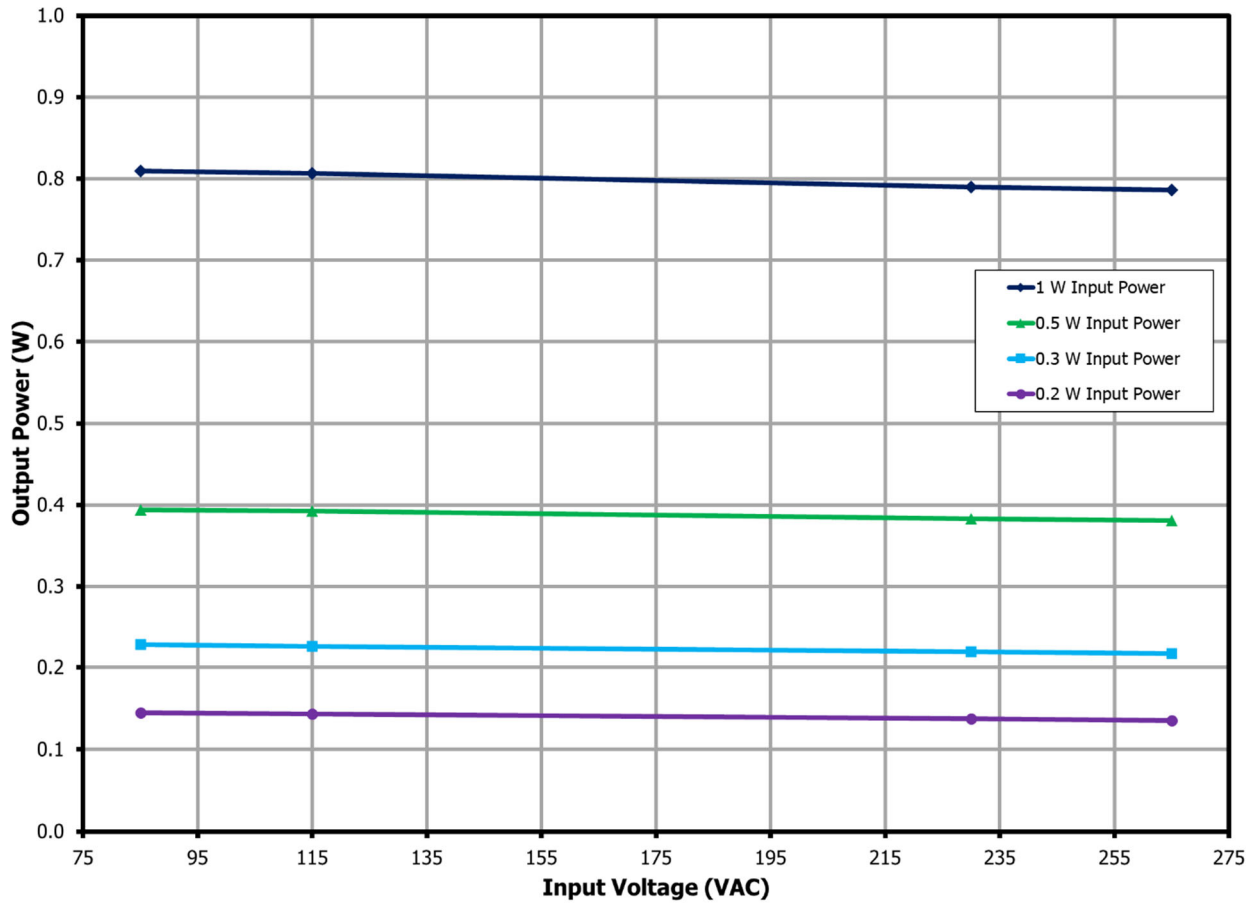

Figure 8 – Available Output Power per Input Power.

8.4.1 0.2 W Input Power

Input Measurement			Output Measurement			Efficiency (%)
V _{IN} (RMS)	I _{IN} (mA)	P _{IN} (W)	V _{OUT} (V)	I _{OUT} (mA)	P _{OUT} (W)	
85	9.58	0.2	12.67	11.40	0.14	72.23
115	7.91	0.2	12.68	11.30	0.14	71.66
230	4.65	0.2	12.71	10.83	0.14	68.79
265	4.04	0.2	12.73	10.63	0.14	67.63

8.4.2 0.3 W Input Power

Input Measurement			Output Measurement			Efficiency (%)
V _{IN} (RMS)	I _{IN} (mA)	P _{IN} (W)	V _{OUT} (V)	I _{OUT} (mA)	P _{OUT} (W)	
85	12.97	0.3	12.51	18.22	0.23	75.98
115	10.55	0.3	12.51	18.03	0.23	75.17
230	6.33	0.3	12.54	17.48	0.22	73.02
265	5.51	0.3	12.54	17.28	0.22	72.20

8.4.3 0.5 W Input Power

Input Measurement			Output Measurement			Efficiency (%)
V _{IN} (RMS)	I _{IN} (mA)	P _{IN} (W)	V _{OUT} (V)	I _{OUT} (mA)	P _{OUT} (W)	
85	19.58	0.5	12.37	31.82	0.39	78.73
115	15.81	0.5	12.36	31.74	0.39	78.46
230	9.55	0.5	12.37	30.98	0.38	76.65
265	8.58	0.5	12.37	30.78	0.38	76.17

8.4.4 1.0 W Input Power

Input Measurement			Output Measurement			Efficiency (%)
V _{IN} (RMS)	I _{IN} (mA)	P _{IN} (W)	V _{OUT} (V)	I _{OUT} (mA)	P _{OUT} (W)	
85	35.16	1	12.24	66.13	0.81	80.95
115	28.44	1	12.24	65.94	0.81	80.68
230	17.28	1	12.23	64.62	0.79	79.00
265	15.481	1	12.23	64.33	0.79	78.64

8.5 *No-Load Input Power*

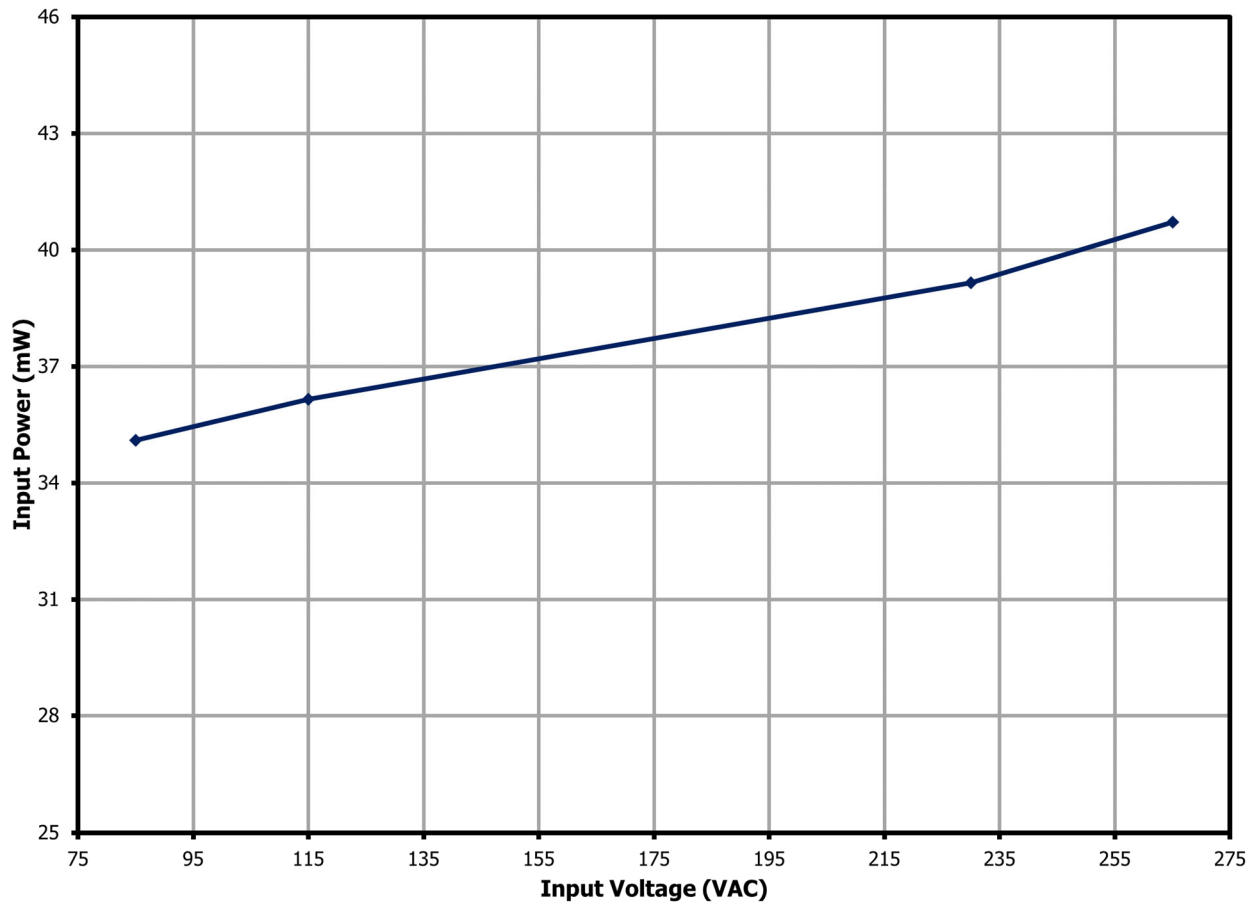

Figure 9 – No-Load Input Power vs. Input Line Voltage, Room Temperature.

8.6 Load Regulation

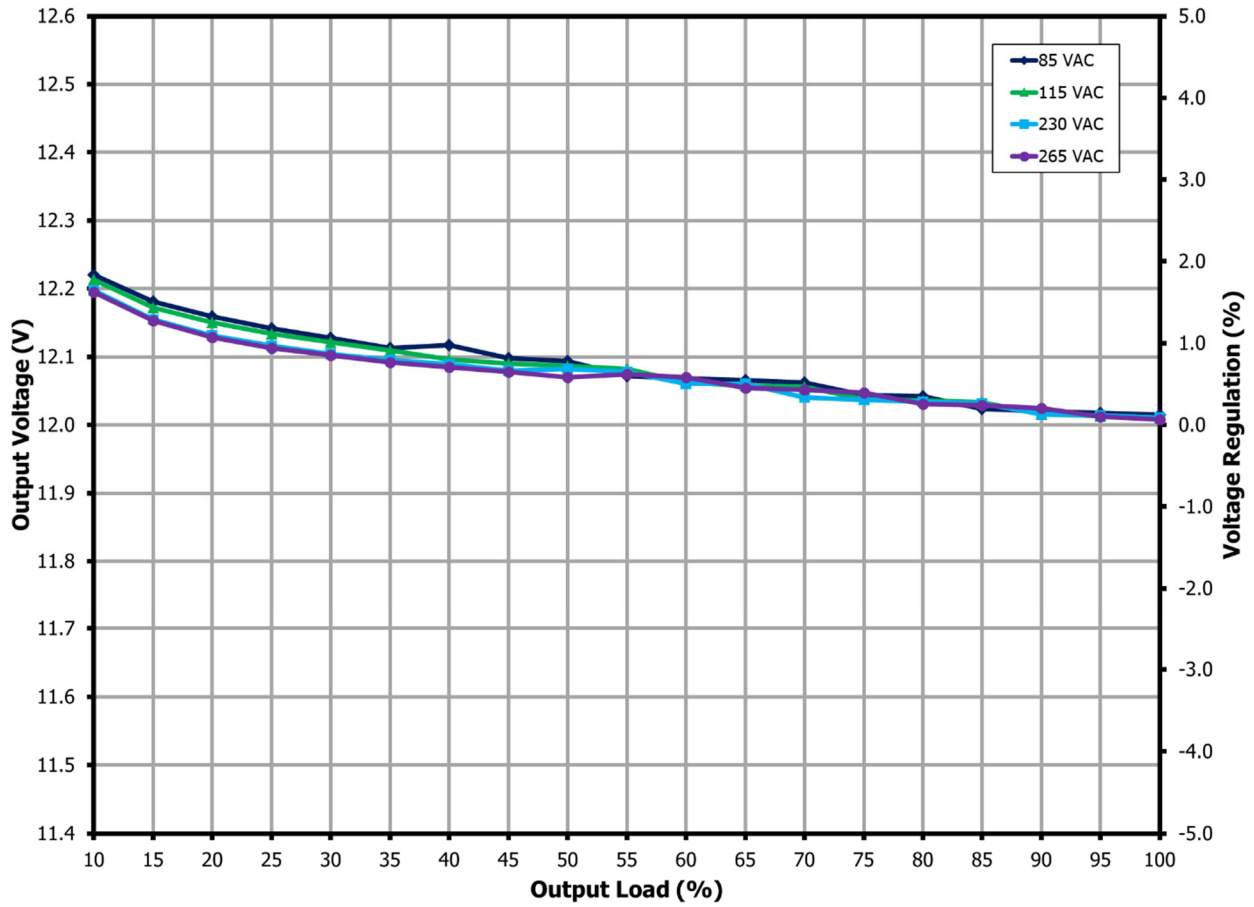

Figure 10 – Output Voltage vs. Output Load, Room Temperature.

8.7 Line Regulation at Full Load

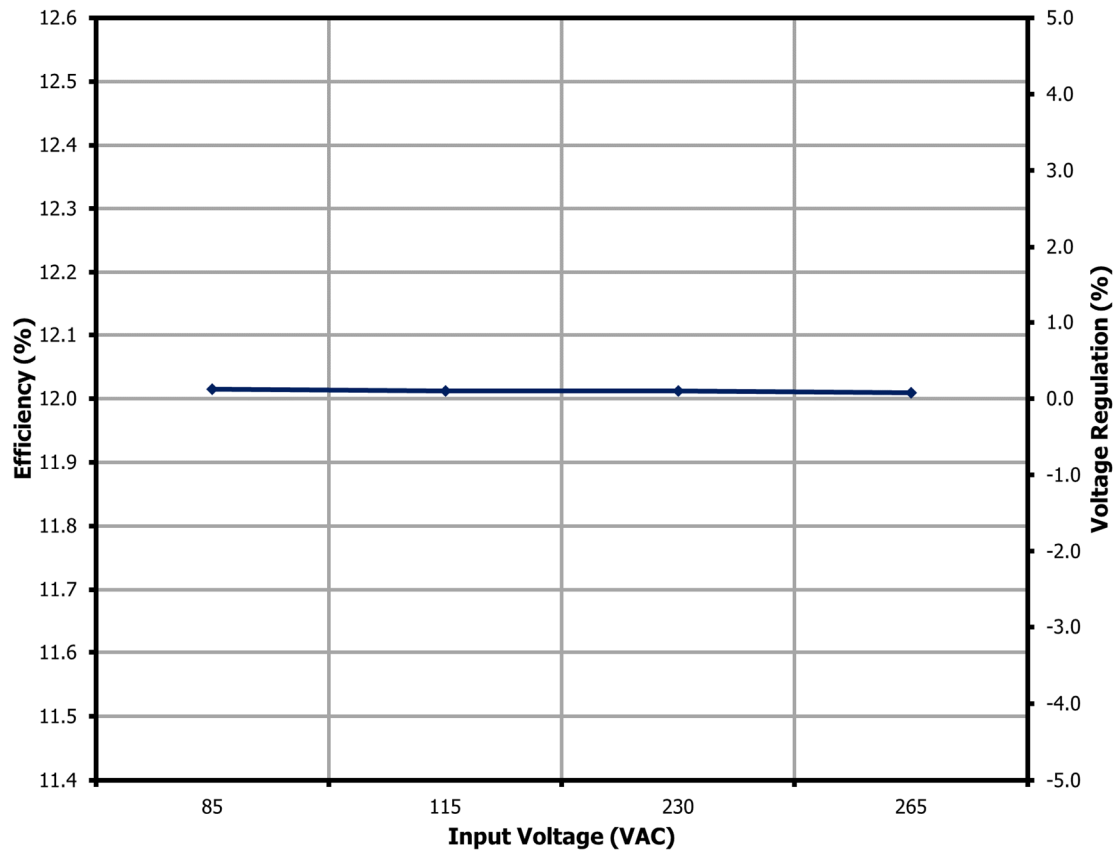

Figure 11 – Output Voltage vs. Input Voltage, Room Temperature.

9 Thermal Performance

9.1 Ambient Thermal Performance



Figure 12 – Buck Choke (EI1), 62.7 °C.
85 VAC, 800 mA Output.

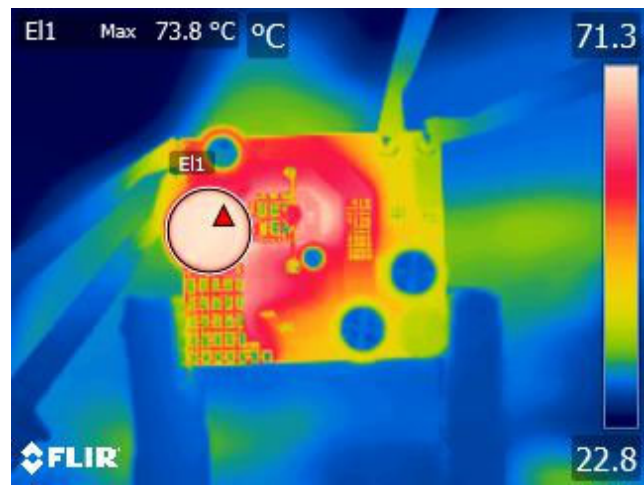

Figure 13 – Buck Choke (EI1), 73.8 °C.
265 VAC, 800 mA Output.



Figure 14 – LNK3209D (Bx1), 65.8 °C.
Buck Diode (Bx2), 69.6 °C.
85 VAC, 800 mA Output.

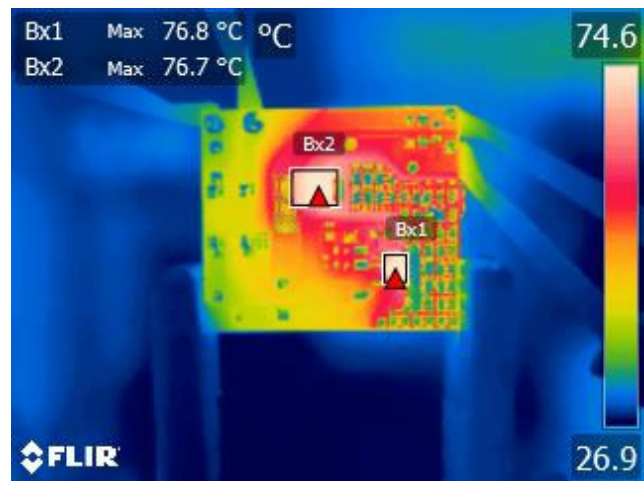

Figure 15 – LNK3209D (Bx1), 76.8 °C.
Buck Diode (Bx2), 76.7 °C.
265 VAC, 800 mA Output.

9.2 **50 °C Thermal Performance**

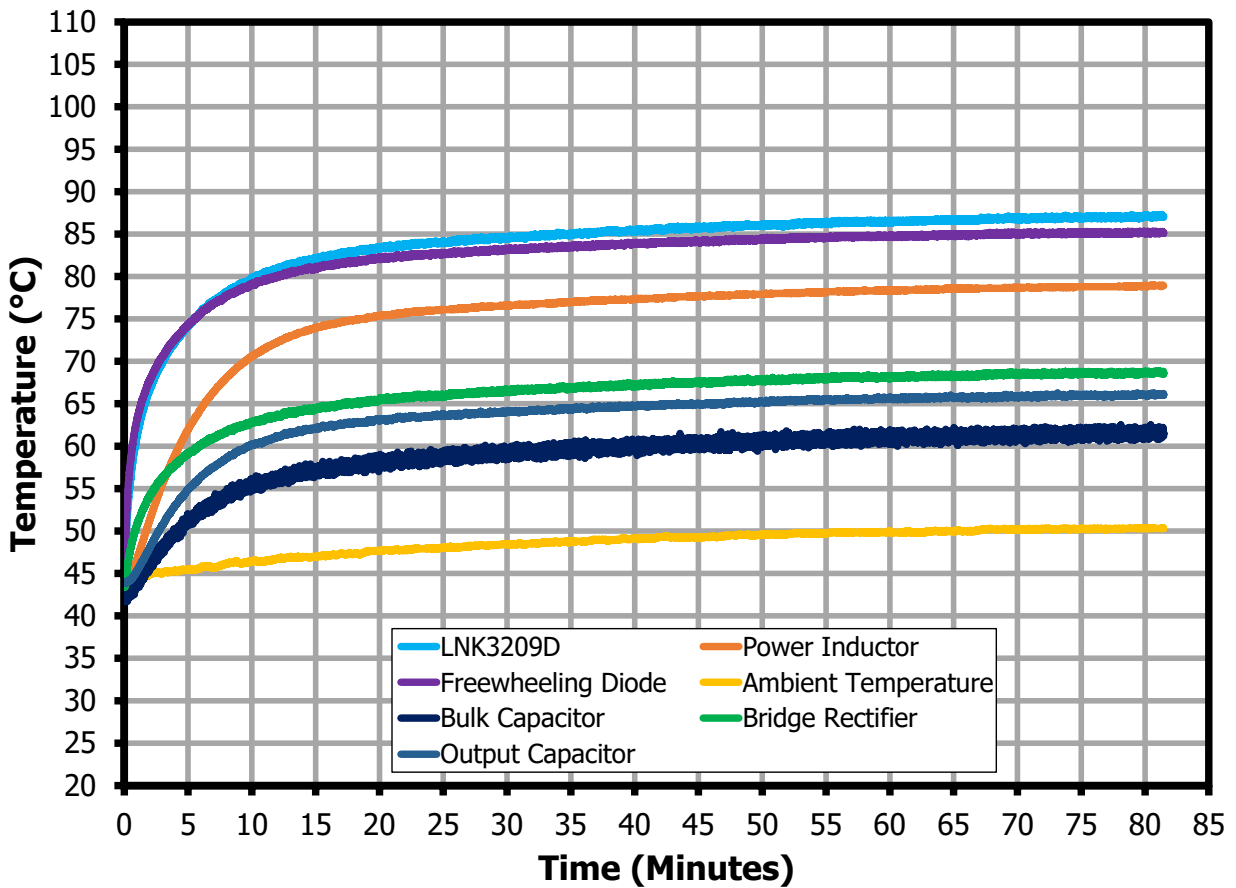

Figure 16 – 85 VAC Thermal Performance at Full Load.

Component	Temperature (°C)
LNK3209D, U1/U2	86.58
Buck Choke, L2	78.46
Buck Diode, D3	84.83
Bulk Capacitor, C2	61.12
Bridge Rectifier, D1	68.24
Output Capacitor, C5	65.7
Ambient	49.93

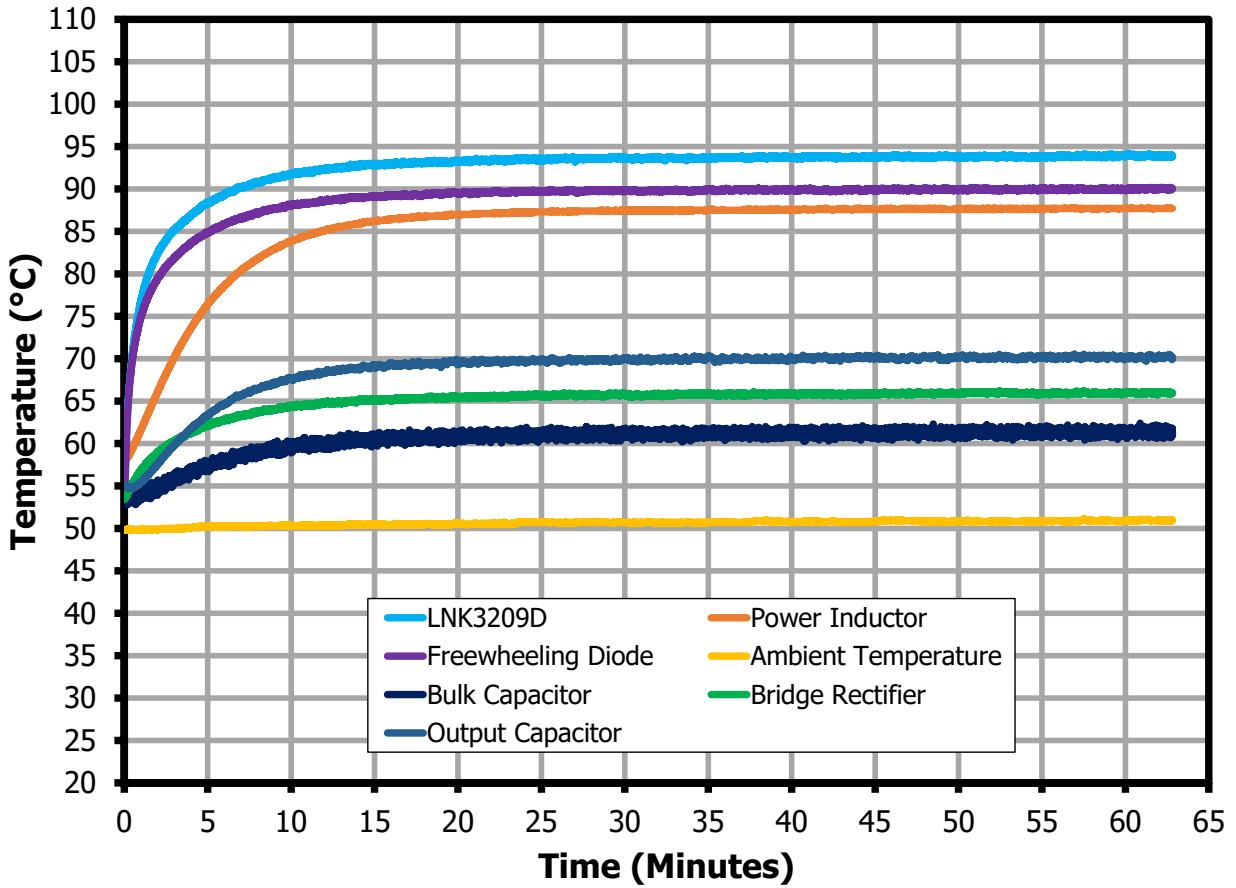

Figure 17 – 265 VAC Thermal Performance at Full Load.

Component	Temperature (°C)
LNK3209D, U1/U2	93.91
Buck Choke, L2	87.7
Buck Diode, D3	90.03
Bulk Capacitor, C2	61.33
Bridge Rectifier, D1	65.96
Output Capacitor, C5	70.19
Ambient	50.95

10 Waveforms

10.1 Switching Waveforms

10.1.1 LNK3209D V_{DS} and I_{DS} Waveforms Normal Operation

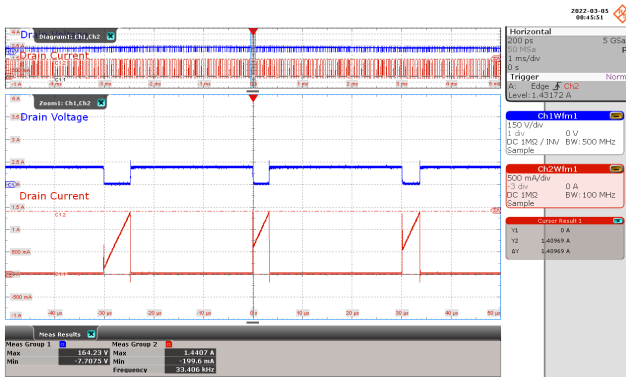

Figure 18 – Drain Voltage and Current Waveforms.
 85 VAC, 800 mA Output.
 Drain Voltage: 150 V / div., 1 ms / div.
 Drain Current: 500 mA / div., 1 ms / div.
 Zoom = 10 μ s / div.
 $I_{DS(MAX)}$ = 1.44 A, $V_{DS(MAX)}$ = 164.23 V.

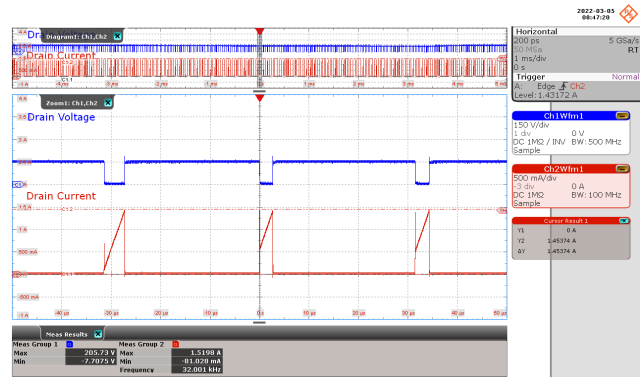

Figure 19 – Drain Voltage and Current Waveforms.
 115 VAC, 800 mA Output.
 Drain Voltage: 150 V / div., 1 ms / div.
 Drain Current: 500 mA / div., 1 ms / div.
 Zoom = 10 μ s / div.
 $I_{DS(MAX)}$ = 1.52 A, $V_{DS(MAX)}$ = 205.73 V.

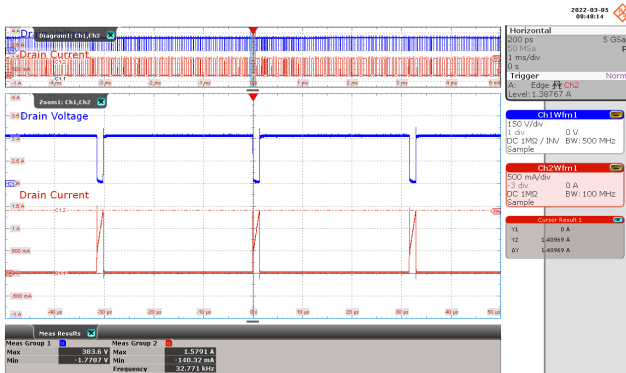

Figure 20 – Drain Voltage and Current Waveforms.
 230 VAC, 800 mA Output.
 Drain Voltage: 150 V / div., 1 ms / div.
 Drain Current: 500 mA / div., 1 ms / div.
 Zoom = 10 μ s / div.
 $I_{DS(MAX)}$ = 1.58 A, $V_{DS(MAX)}$ = 383.6 V.

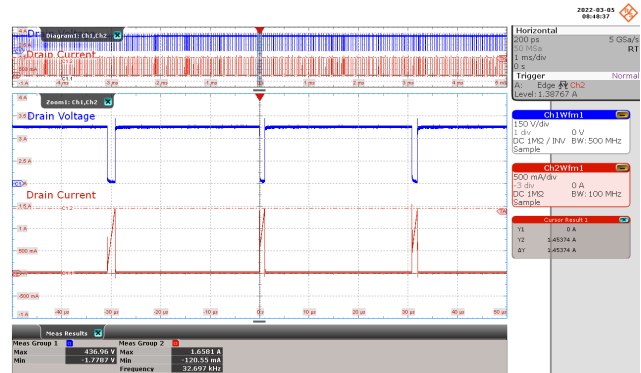

Figure 21 – Drain Voltage and Current Waveforms.
 265 VAC, 800 mA Output.
 Drain Voltage: 150 V / div., 1 ms / div.
 Drain Current: 500 mA / div., 1 ms / div.
 Zoom = 10 μ s / div.
 $I_{DS(MAX)}$ = 1.66 A, $V_{DS(MAX)}$ = 436.96 V.

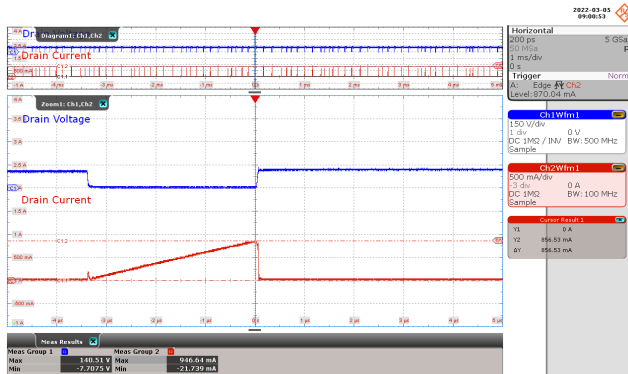

Figure 22 – Drain Voltage and Current Waveforms.
 85 VAC, 80 mA Output.
 Drain Voltage: 150 V / div., 1 ms / div.
 Drain Current: 500 mA / div., 1 ms / div.
 Zoom = 1 μ s / div.
 $I_{DS(MAX)} = 946.64$ mA, $V_{DS(MAX)} = 140.51$ V.

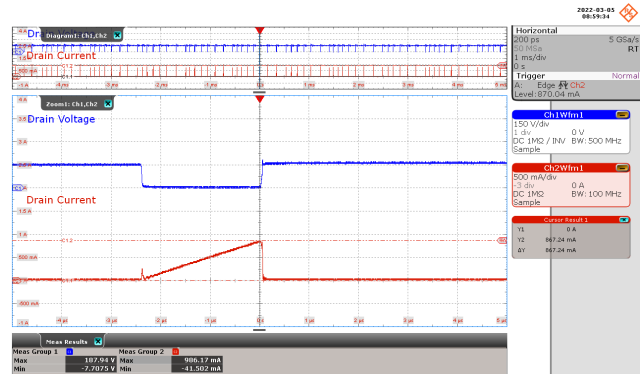

Figure 23 – Drain Voltage and Current Waveforms.
 115 VAC, 80 mA Output.
 Drain Voltage: 150 V / div., 1 ms / div.
 Drain Current: 500 mA / div., 1 ms / div.
 Zoom = 1 μ s / div.
 $I_{DS(MAX)} = 986.17$ mA, $V_{DS(MAX)} = 187.94$ V.

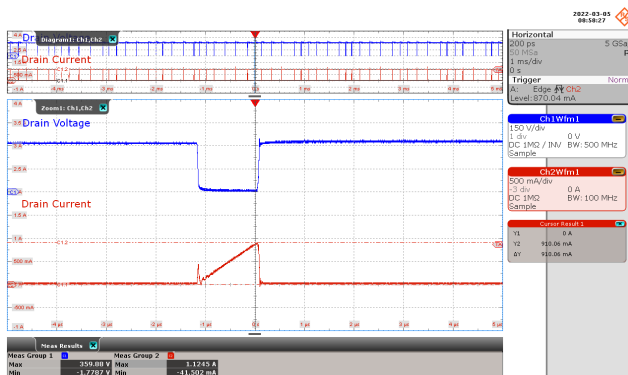

Figure 24 – Drain Voltage and Current Waveforms.
 230 VAC, 80 mA Output.
 Drain Voltage: 150 V / div., 1 ms / div.
 Drain Current: 500 mA / div., 1 ms / div.
 Zoom = 1 μ s / div.
 $I_{DS(MAX)} = 1.12$ mA, $V_{DS(MAX)} = 359.88$ V.

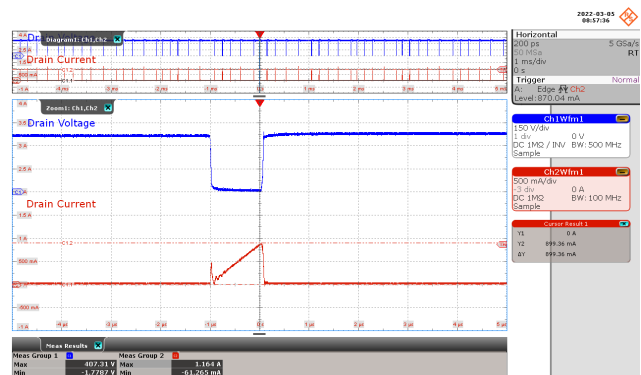

Figure 25 – Drain Voltage and Current Waveforms.
 265 VAC, 80 mA Output.
 Drain Voltage: 150 V / div., 1 ms / div.
 Drain Current: 500 mA / div., 1 ms / div.
 Zoom = 1 μ s / div.
 $I_{DS(MAX)} = 1.16$ mA, $V_{DS(MAX)} = 407.31$ V.

10.1.2 LNK3209D Drain Voltage and Current Waveforms During Start-Up

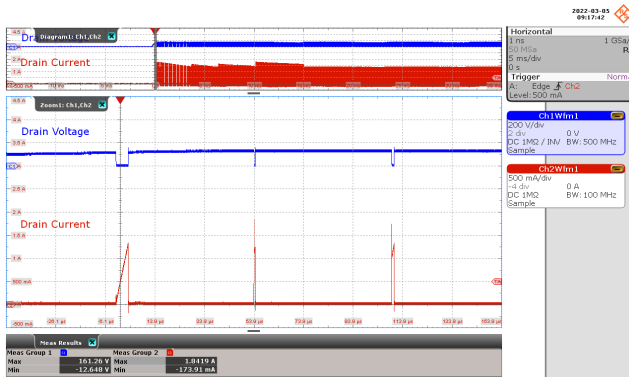

Figure 26 – Drain Voltage and Current Waveforms.
 85 VAC, 800 mA Output.
 Drain Voltage: 200 V / div., 5 ms / div.
 Drain Current: 500 mA / div., 5 ms / div.
 Zoom = 20 μs / div.
 $I_{DS(MAX)} = 1.84 \text{ A}$, $V_{DS(MAX)} = 161.26 \text{ V}$.

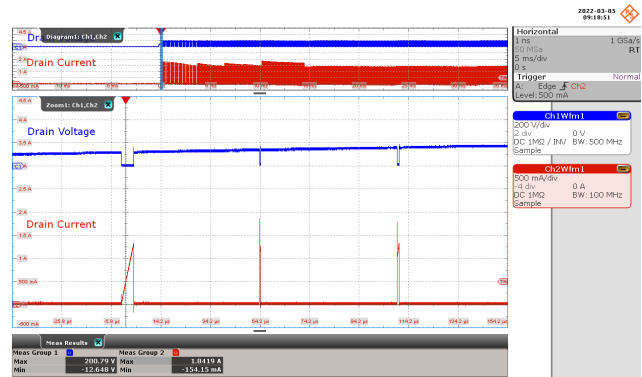

Figure 27 – Drain Voltage and Current Waveforms.
 115 VAC, 800 mA Output.
 Drain Voltage: 200 V / div., 5 ms / div.
 Drain Current: 500 mA / div., 5 ms / div.
 Zoom = 20 μs / div.
 $I_{DS(MAX)} = 1.84 \text{ A}$, $V_{DS(MAX)} = 200.79 \text{ V}$.

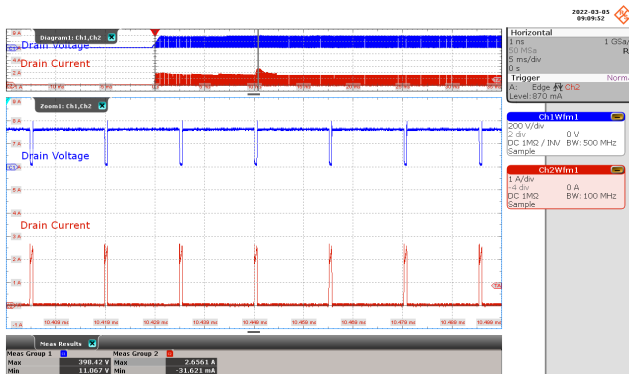

Figure 28 – Drain Voltage and Current Waveforms.
 230 VAC, 800 mA Output.
 Drain Voltage: 200 V / div., 5 ms / div.
 Drain Current: 1 A / div., 5 ms / div.
 Zoom = 10 μs / div.
 $I_{DS(MAX)} = 2.66 \text{ A}$, $V_{DS(MAX)} = 398.42 \text{ V}$.

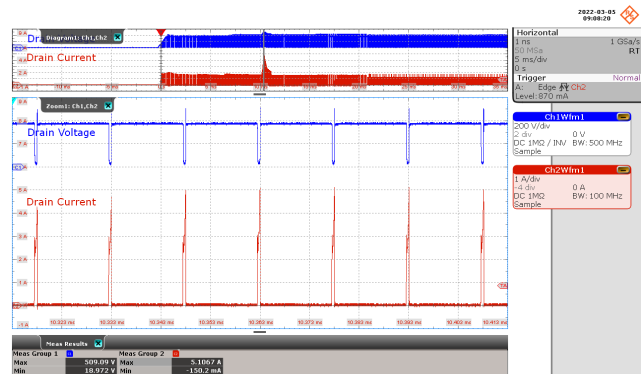

Figure 29 – Drain Voltage and Current Waveforms.
 265 VAC, 800 mA Output.
 Drain Voltage: 200 V / div., 5 ms / div.
 Drain Current: 1 A / div., 5 ms / div.
 Zoom = 10 μs / div.
 $I_{DS(MAX)} = 5.11 \text{ A}$, $V_{DS(MAX)} = 509.09 \text{ V}$.

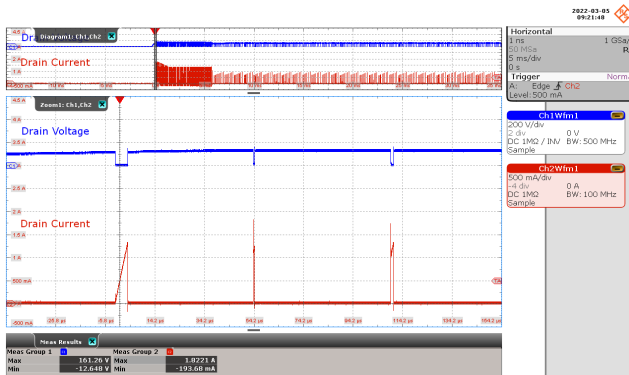

Figure 30 – Drain Voltage and Current Waveforms.
 85 VAC, 80 mA Output.
 Drain Voltage: 200 V / div., 5 ms / div.
 Drain Current: 500 mA / div., 5 ms / div.
 Zoom = 20 μ s / div.
 $I_{DS(MAX)}$ = 1.82 A, $V_{DS(MAX)}$ = 161.26 V.

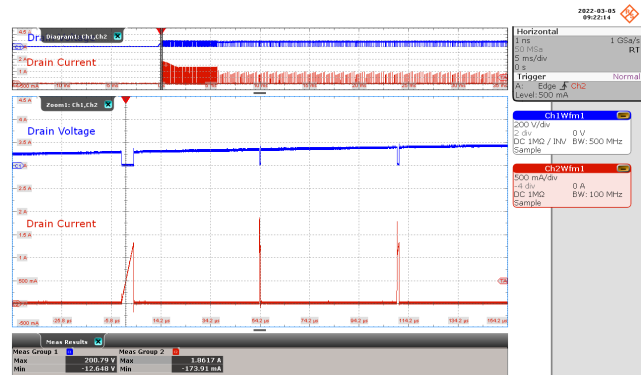

Figure 31 – Drain Voltage and Current Waveforms.
 115 VAC, 80 mA Output.
 Drain Voltage: 200 V / div., 5 ms / div.
 Drain Current: 500 mA / div., 5 ms / div.
 Zoom = 20 μ s / div.
 $I_{DS(MAX)}$ = 1.86 A, $V_{DS(MAX)}$ = 200.79 V.

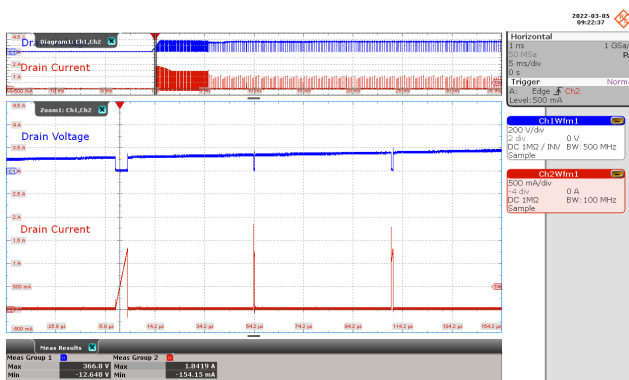

Figure 32 – Drain Voltage and Current Waveforms.
 230 VAC, 80 mA Output.
 Drain Voltage: 200 V / div., 5 ms / div.
 Drain Current: 500 mA / div., 5 ms / div.
 Zoom = 20 μ s / div.
 $I_{DS(MAX)}$ = 1.84 A, $V_{DS(MAX)}$ = 366.8 V.

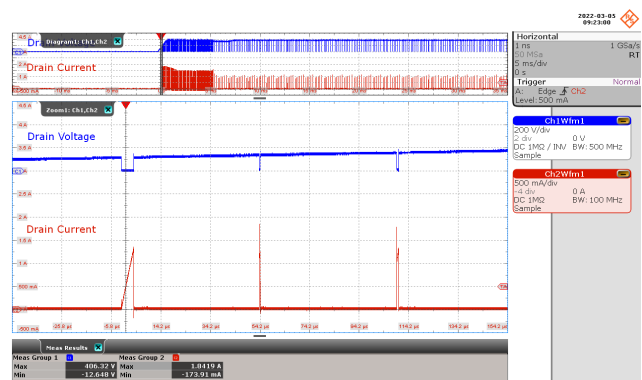

Figure 33 – Drain Voltage and Current Waveforms.
 265 VAC, 80 mA Output.
 Drain Voltage: 200 V / div., 5 ms / div.
 Drain Current: 500 mA / div., 5 ms / div.
 Zoom = 20 μ s / div.
 $I_{DS(MAX)}$ = 1.84 A, $V_{DS(MAX)}$ = 406.32 V.

10.1.3 Drain Current and Output Waveform During Output Short



Figure 34 – Drain Current and Output Waveforms.
85 VAC Input.
Drain Current: 2 A / div., 1 s / div.
Output Voltage: 6 V / div., 1 s / div.
Output Current: 2 A / div., 1 s / div.
Zoom = 10 ms / div.

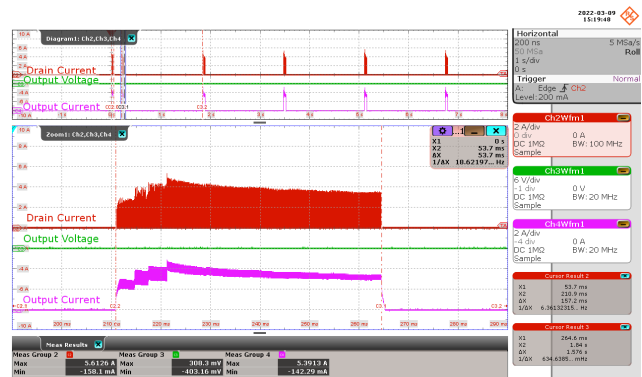

Figure 35 – Drain Current and Output Waveforms.
265 VAC Input.
Drain Current: 2 A / div., 1 s / div.
Output Voltage: 6 V / div., 1 s / div.
Output Current: 2 A / div., 1 s / div.
Zoom = 10 ms / div.

10.1.4 Freewheeling Diode Waveforms Normal Operation

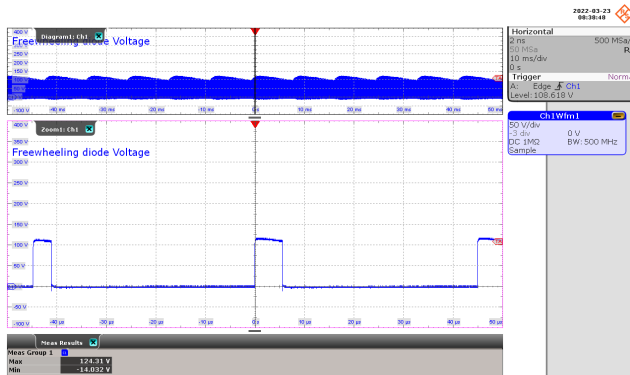

Figure 36 – Freewheeling Diode Voltage Waveforms. 85 VAC, 800 mA Output.
 Diode Voltage: 50 V / div., 10 ms / div.
 Zoom: 10 μ s / div.
 V_{MAX} : 124.31 V.

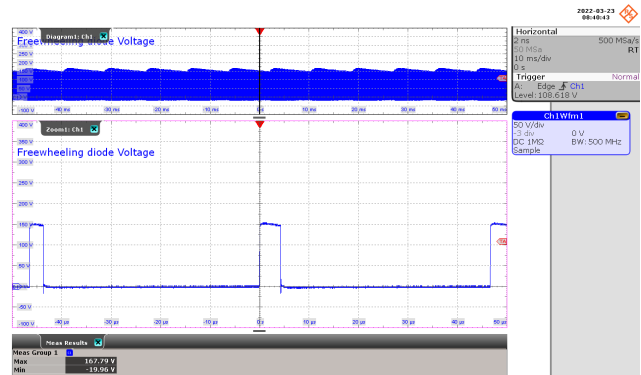

Figure 37 – Freewheeling Diode Voltage Waveforms. 115 VAC, 800 mA Output.
 Diode Voltage: 50 V / div., 10 ms / div.
 Zoom: 10 μ s / div.
 V_{MAX} : 167.79 V.

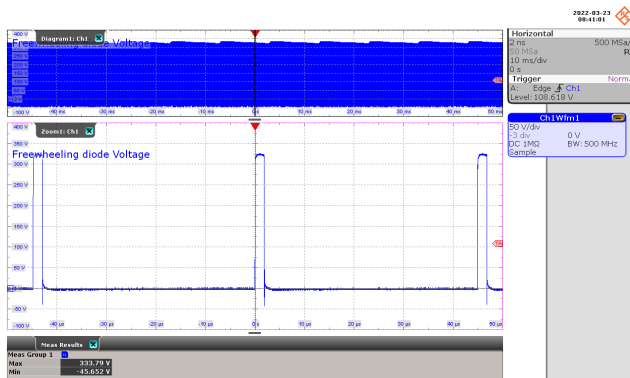

Figure 38 – Freewheeling Diode Voltage Waveforms. 230 VAC, 800 mA Output.
 Diode Voltage: 50 V / div., 10 ms / div.
 Zoom: 10 μ s / div.
 V_{MAX} : 333.79 V.

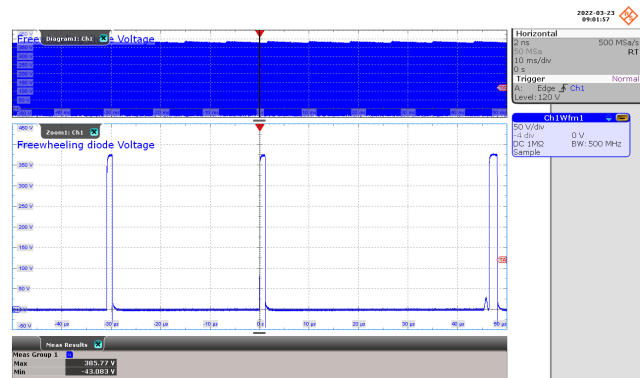

Figure 39 – Freewheeling Diode Voltage Waveforms. 265 VAC, 800 mA Output.
 Diode Voltage: 50 V / div., 10 ms / div.
 Zoom: 10 μ s / div.
 V_{MAX} : 385.77 V.

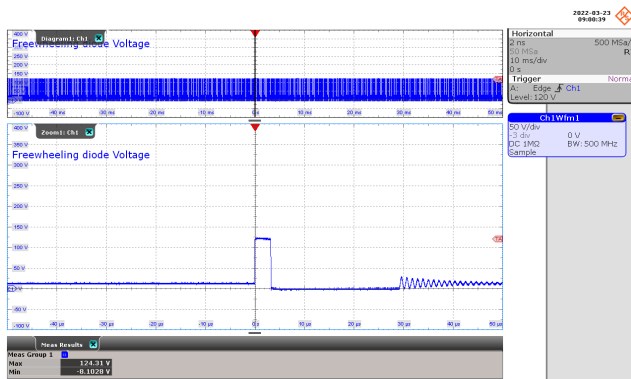

Figure 40 – Freewheeling Diode Voltage Waveforms.
 85 VAC, 80 mA Output.
 Diode Voltage: 50 V / div., 10 ms / div.
 Zoom: 10 μs / div.
 V_{MAX}: 124.31 V.

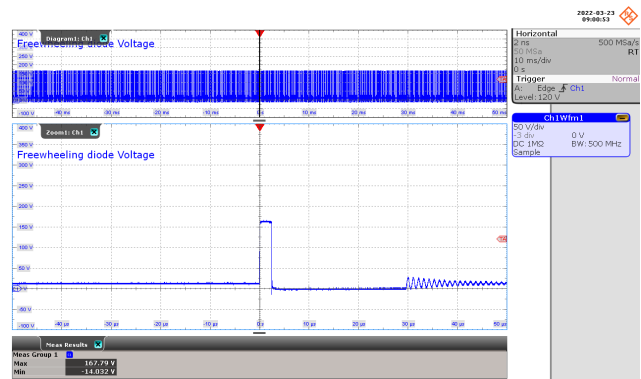

Figure 41 – Freewheeling Diode Voltage Waveforms.
 115 VAC, 80 mA Output.
 Diode Voltage: 50 V / div., 10 ms / div.
 Zoom: 10 μs / div.
 V_{MAX}: 167.79 V.

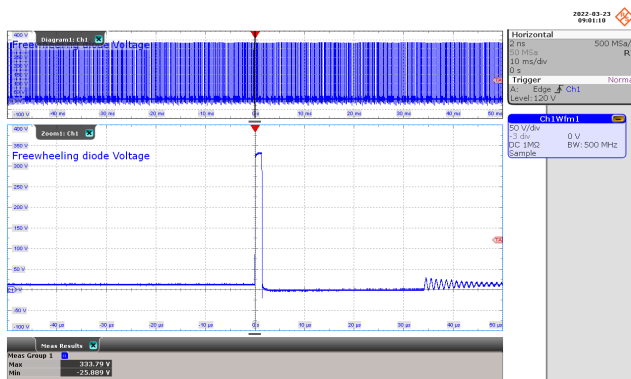

Figure 42 – Freewheeling Diode Voltage Waveforms.
 230 VAC, 80 mA Output.
 Diode Voltage: 50 V / div., 10 ms / div.
 Zoom: 10 μs / div.
 V_{MAX}: 333.79 V.

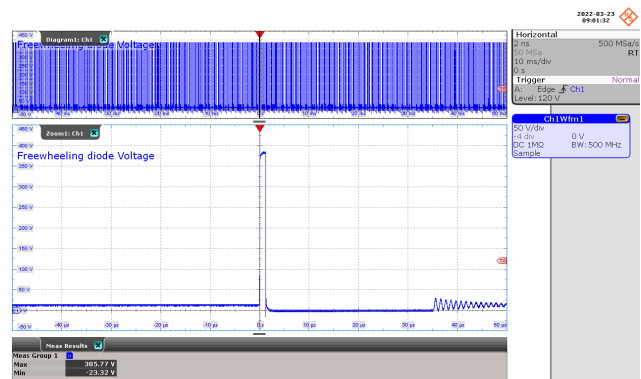

Figure 43 – Freewheeling Diode Voltage Waveforms.
 265 VAC, 80 mA Output.
 Diode Voltage: 50 V / div., 10 ms / div.
 Zoom: 10 μs / div.
 V_{MAX}: 385.77 V.

10.1.5 Freewheeling Diode Waveforms During Start-Up

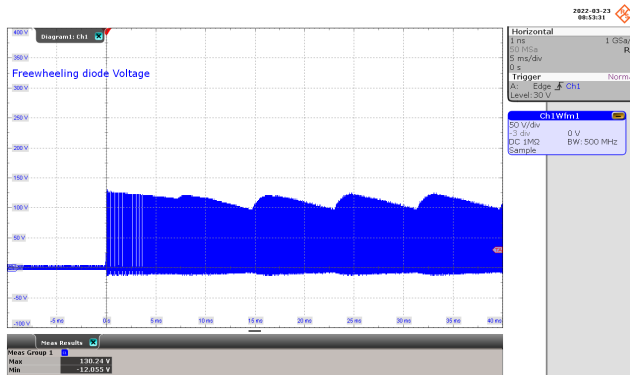

Figure 44 – Freewheeling Diode Voltage Waveforms.
 85 VAC, 800 mA Output.
 Diode Voltage: 50 V / div., 5 ms / div.
 V_{MAX} : 130.24 V.

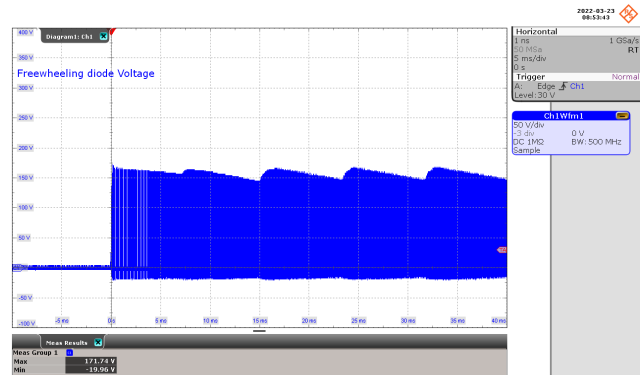

Figure 45 – Freewheeling Diode Voltage Waveforms.
 115 VAC, 800 mA Output.
 Diode Voltage: 50 V / div., 5 ms / div.
 V_{MAX} : 171.74 V.

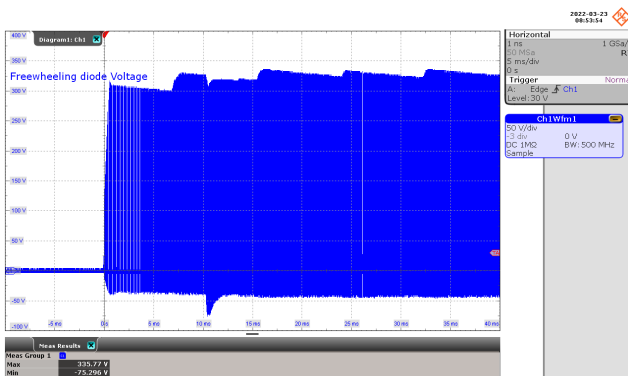

Figure 46 – Freewheeling Diode Voltage Waveforms.
 230 VAC, 800 mA Output.
 Diode Voltage: 50 V / div., 5 ms / div.
 V_{MAX} : 335.77 V.

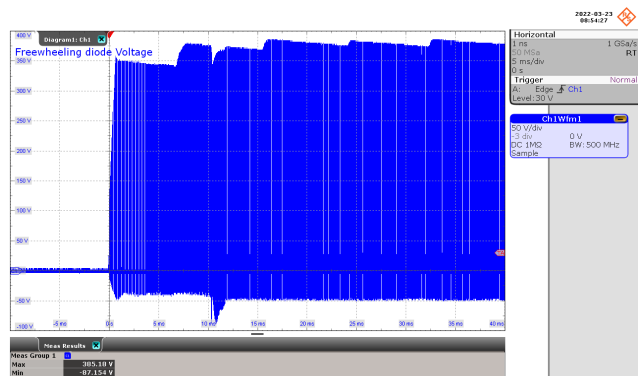

Figure 47 – Freewheeling Diode Voltage Waveforms.
 265 VAC, 800 mA Output.
 Diode Voltage: 50 V / div., 5 ms / div.
 V_{MAX} : 385.18 V.

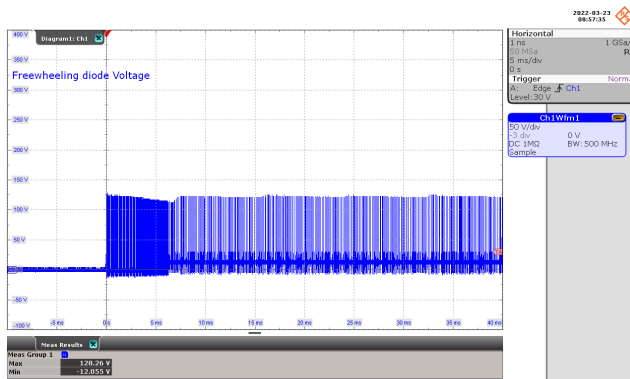

Figure 48 – Freewheeling Diode Voltage Waveforms. 85 VAC, 80 mA Output.
 Diode Voltage: 50 V / div., 5 ms / div.
 V_{MAX} : 128.26 V.

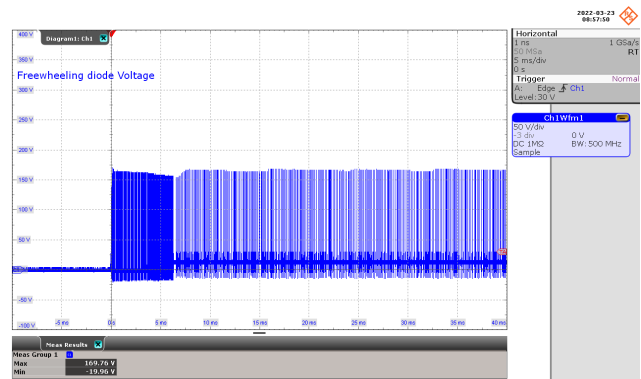

Figure 49 – Freewheeling Diode Voltage Waveforms. 115 VAC, 80 mA Output.
 Diode Voltage: 50 V / div., 5 ms / div.
 V_{MAX} : 169.76 V.

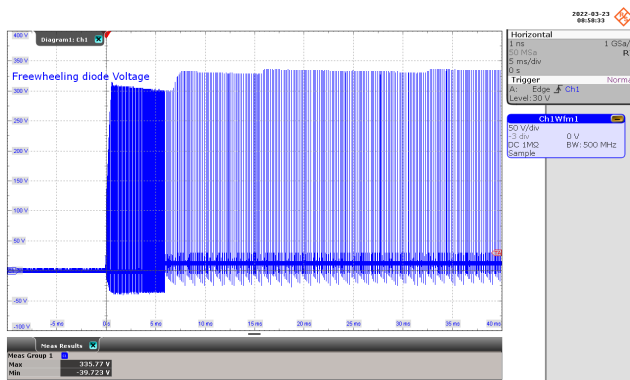

Figure 50 – Freewheeling Diode Voltage Waveforms. 230 VAC, 80 mA Output.
 Diode Voltage: 50 V / div., 5 ms / div.
 V_{MAX} : 335.77 V.

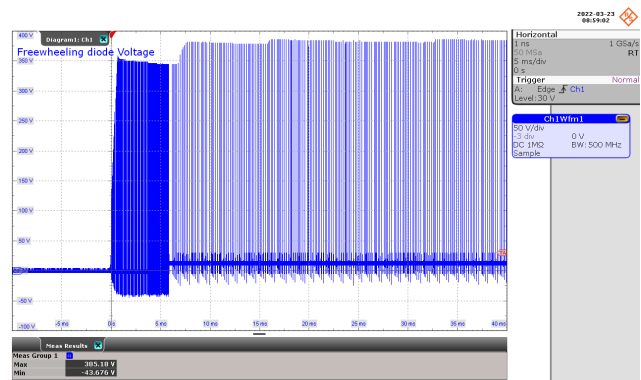

Figure 51 – Freewheeling Diode Voltage Waveforms. 265 VAC, 80 mA Output.
 Diode Voltage: 50 V / div., 5 ms / div.
 V_{MAX} : 385.18 V.

10.1.6 Output Voltage and Current Waveforms During Start-Up (CC mode)

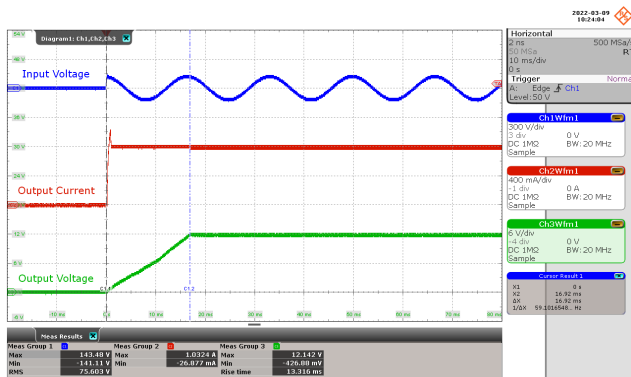

Figure 52 – Output Voltage and Current Waveforms.
 85 VAC, 800 mA Output.
 Input Voltage: 300 V / div., 10 ms / div.
 Output Current: 400 mA / div., 10 ms / div.
 Output Voltage: 6 V / div., 10 ms / div.
 Rise Time = 13.316 ms.

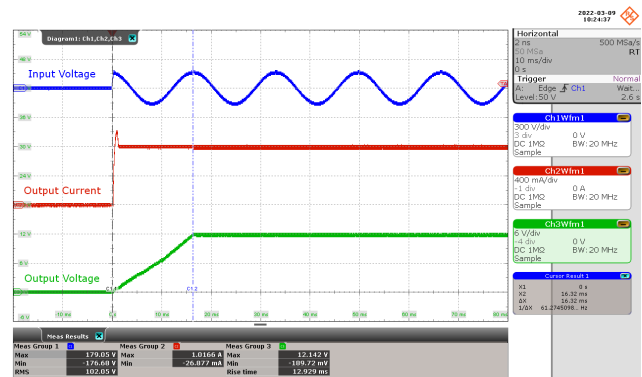

Figure 53 – Output Voltage and Current Waveforms.
 115 VAC, 800 mA Output.
 Input Voltage: 300 V / div., 10 ms / div.
 Output Current: 400 mA / div., 10 ms / div.
 Output Voltage: 6 V / div., 10 ms / div.
 Rise Time = 12.929 ms.

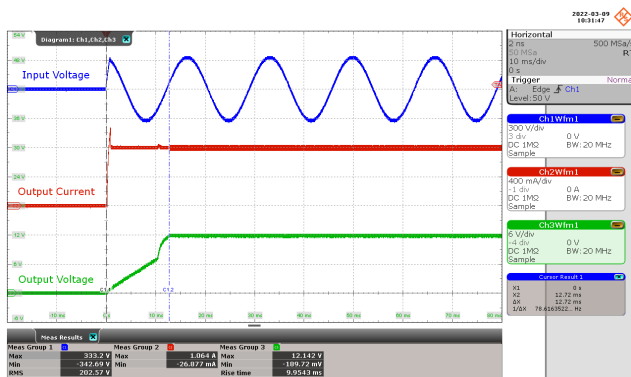

Figure 54 – Output Voltage and Current Waveforms.
 230 VAC, 800 mA Output.
 Input Voltage: 300 V / div., 10 ms / div.
 Output Current: 400 mA / div., 10 ms / div.
 Output Voltage: 6 V / div., 10 ms / div.
 Rise Time = 9.9543 ms.

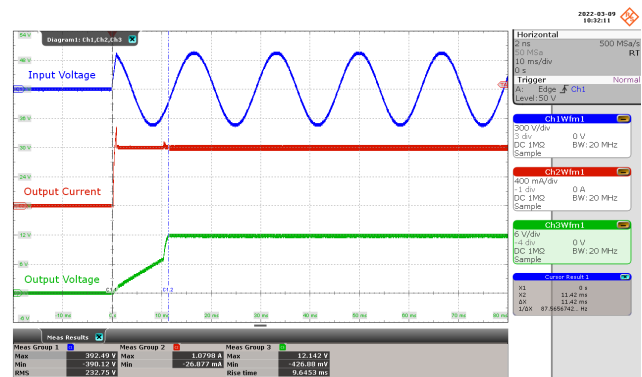

Figure 55 – Output Voltage and Current Waveforms.
 265 VAC, 800 mA Output.
 Input Voltage: 300 V / div., 10 ms / div.
 Output Current: 400 mA / div., 10 ms / div.
 Output Voltage: 6 V / div., 10 ms / div.
 Rise Time = 9.6453 ms.

10.1.7 Output Voltage and Current Waveforms During Start-Up (CR mode)

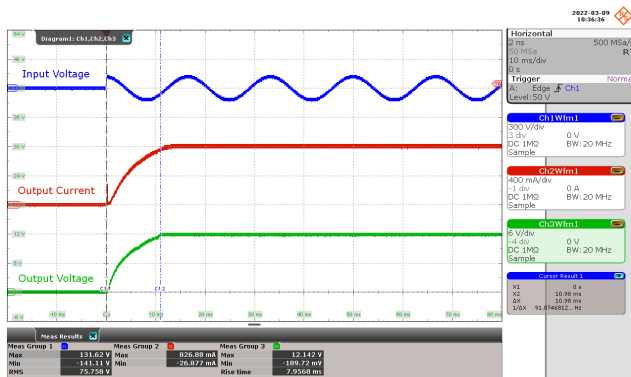

Figure 56 – Output Voltage and Current Waveforms.
 85 VAC, 15 Ω Load.
 Input Voltage: 300 V / div., 10 ms / div.
 Output Current: 400 mA / div., 10 ms / div.
 Output Voltage: 6 V / div., 10 ms / div.
 Rise Time = 7.9568 ms.

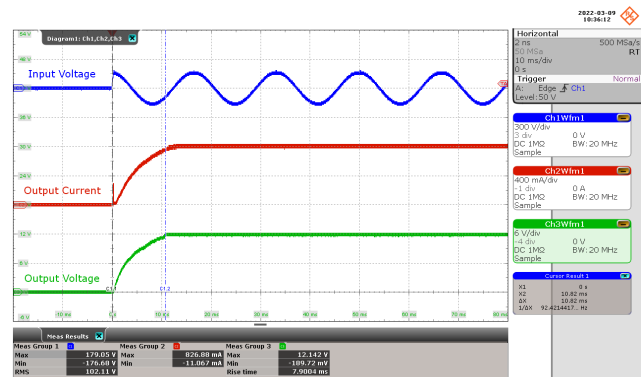

Figure 57 – Output Voltage and Current Waveforms.
 115 VAC, 15 Ω Load.
 Input Voltage: 300 V / div., 10 ms / div.
 Output Current: 400 mA / div., 10 ms / div.
 Output Voltage: 6 V / div., 10 ms / div.
 Rise Time = 7.9004 ms.

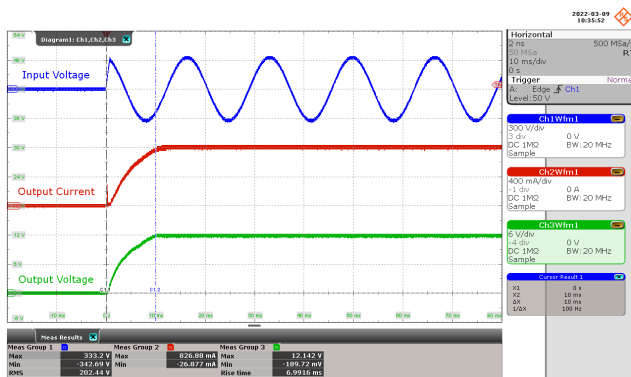

Figure 58 – Output Voltage and Current Waveforms.
 230 VAC, 15 Ω Load.
 Input Voltage: 300 V / div., 10 ms / div.
 Output Current: 400 mA / div., 10 ms / div.
 Output Voltage: 6 V / div., 10 ms / div.
 Rise Time = 6.9916 ms.

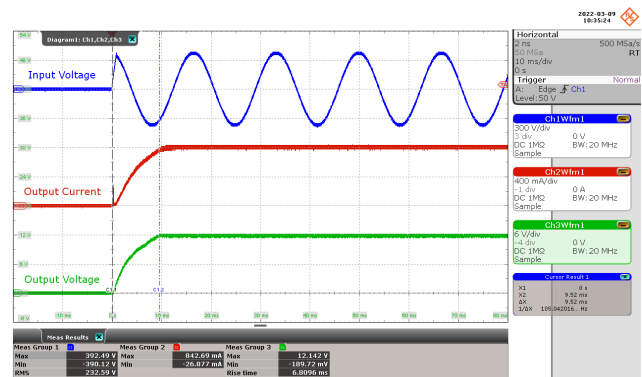

Figure 59 – Output Voltage and Current Waveforms.
 265 VAC, 15 Ω Load.
 Input Voltage: 300 V / div., 10 ms / div.
 Output Current: 400 mA / div., 10 ms / div.
 Output Voltage: 6 V / div., 10 ms / div.
 Rise Time = 6.8096 ms.

10.1.8 Output Voltage and Current Waveforms During Start-Up (Min-Load)

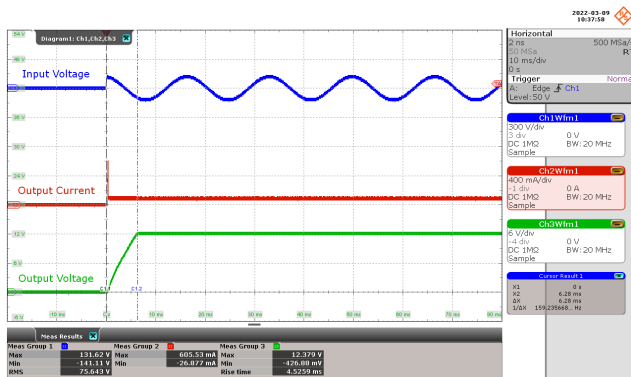

Figure 60 – Output Voltage and Current Waveforms.
 85 VAC, 80 mA Output.
 Input Voltage: 300 V / div., 10 ms / div.
 Output Current: 400 mA / div., 10 ms / div.
 Output Voltage: 6 V / div., 10 ms / div.
 Rise Time = 4.5259 ms.

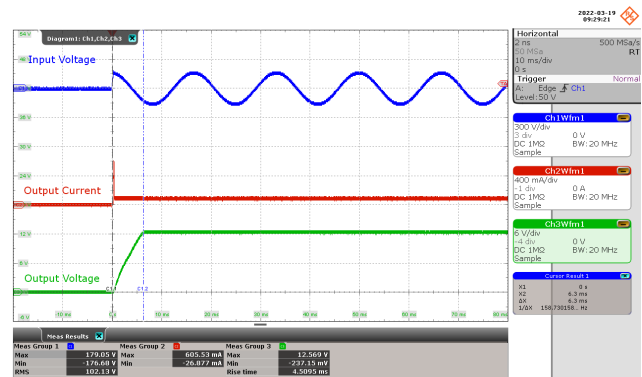

Figure 61 – Output Voltage and Current Waveforms.
 115 VAC, 80 mA Output.
 Input Voltage: 300 V / div., 10 ms / div.
 Output Current: 400 mA / div., 10 ms / div.
 Output Voltage: 6 V / div., 10 ms / div.
 Rise Time = 4.5095 ms.

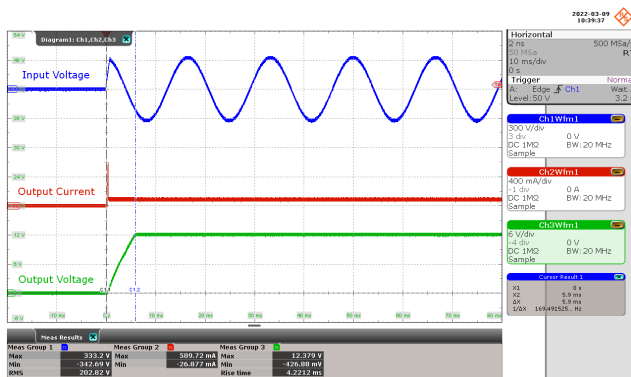

Figure 62 – Output Voltage and Current Waveforms.
 85 VAC, 80 mA Output.
 Input Voltage: 300 V / div., 10 ms / div.
 Output Current: 400 mA / div., 10 ms / div.
 Output Voltage: 6 V / div., 10 ms / div.
 Rise Time = 4.2212 ms.

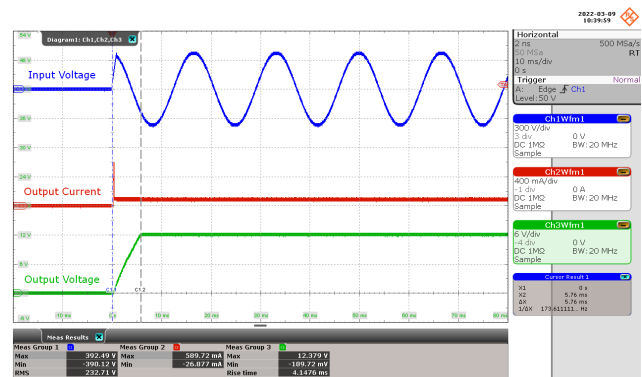

Figure 63 – Output Voltage and Current Waveforms.
 265 VAC, 80 mA Output.
 Input Voltage: 300 V / div., 10 ms / div.
 Output Current: 400 mA / div., 10 ms / div.
 Output Voltage: 6 V / div., 10 ms / div.
 Rise Time = 4.1476 ms.

10.2 **Output Ripple Measurements**

10.2.1 Ripple Measurement Technique

For DC output ripple measurements, a modified oscilloscope test probe must be utilized to reduce spurious signals due to pick-up. Details of the probe modification are provided in the Figures below.

The 4987BA probe adapter is affixed with two capacitors tied in parallel across the probe tip. The capacitors include one (1) 0.1 μF / 50 V ceramic type and one (1) 1 μF / 50 V aluminum electrolytic. The aluminum electrolytic type capacitor is polarized, so proper polarity across DC outputs must be maintained (see below).

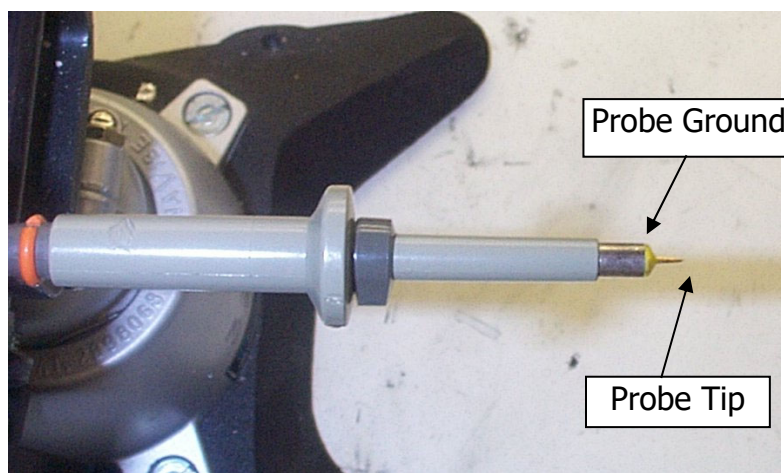

Figure 64 – Oscilloscope Probe Prepared for Ripple Measurement. (End Cap and Ground Lead Removed.)

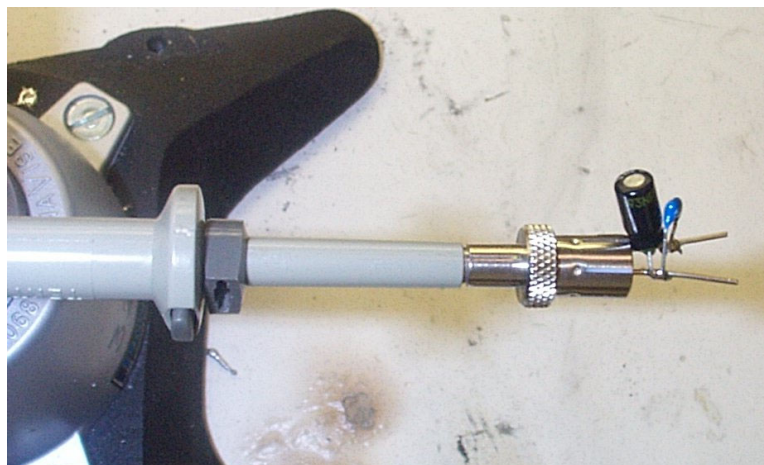

Figure 65 – Oscilloscope Probe with Probe Master (www.probemaster.com) 4987A BNC Adapter. (Modified with wires for ripple measurement, and two parallel decoupling capacitors added.)

10.2.2 Measurement Results

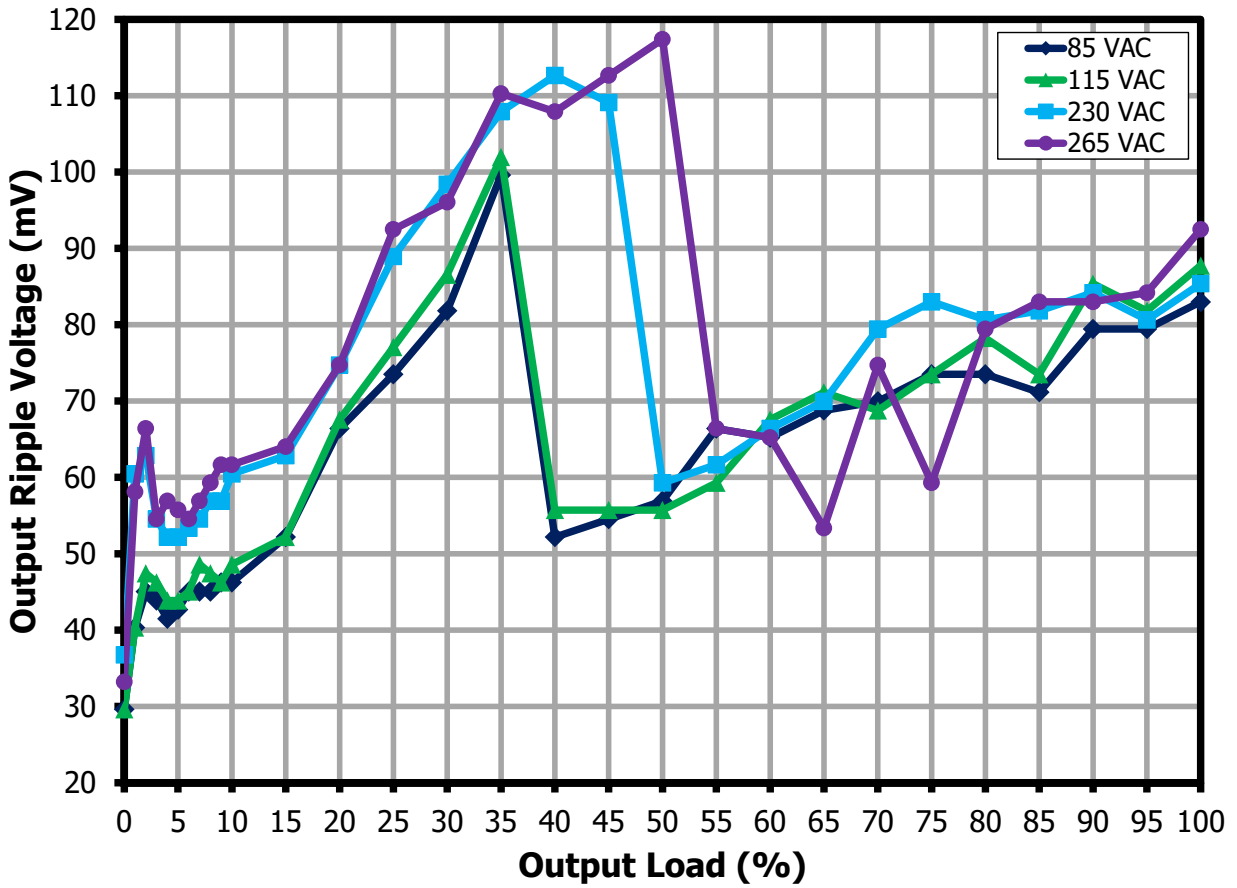

Figure 66 – Output Ripple Voltage.

10.2.3 Ripple Voltage Waveforms

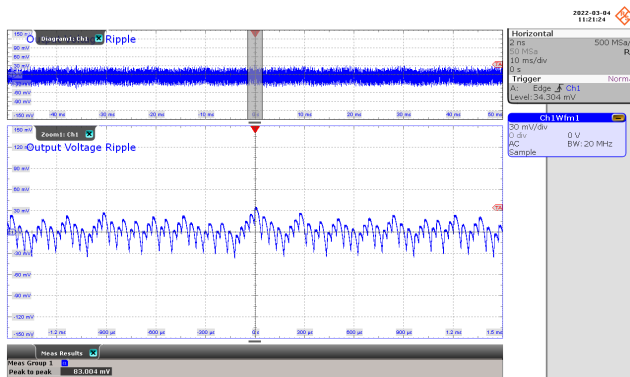

Figure 67 – Output Voltage Ripple Waveforms.
 85 VAC, 800 mA Output.
 Ripple: 30 mV / div., 10 ms / div.
 Zoom: 300 μs / div.
 V_{PK-PK}: 83.004 mV.

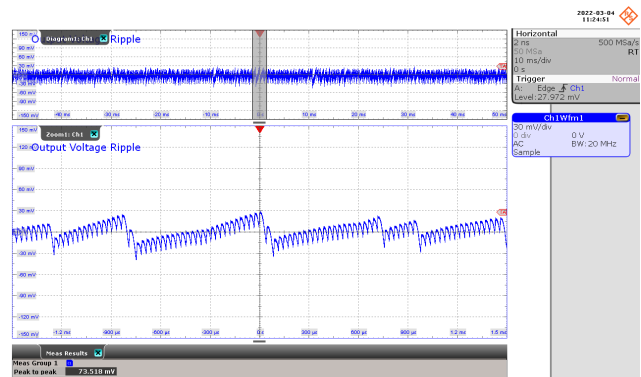

Figure 68 – Output Voltage Ripple Waveforms.
 85 VAC, 600 mA Output.
 Ripple: 30 mV / div., 10 ms / div.
 Zoom: 300 μs / div.
 V_{PK-PK}: 73.518 mV.

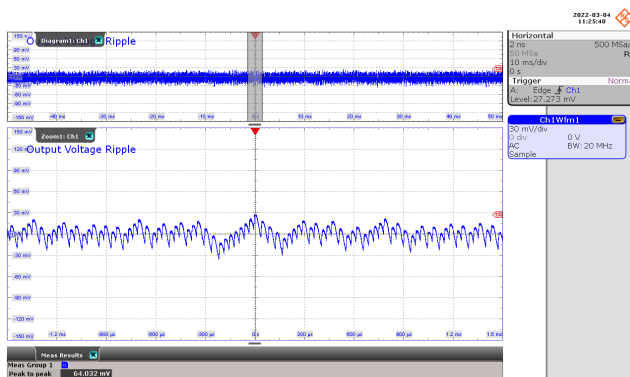

Figure 69 – Output Voltage Ripple Waveforms.
 85 VAC, 400 mA Output.
 Ripple: 30 mV / div., 10 ms / div.
 Zoom: 300 μs / div.
 V_{PK-PK}: 64.032 mV.

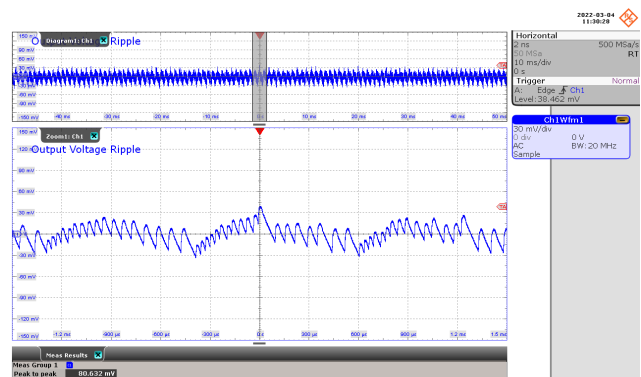

Figure 70 – Output Voltage Ripple Waveforms.
 85 VAC, 200 mA Output.
 Ripple: 30 mV / div., 10 ms / div.
 Zoom: 300 μs / div.
 V_{PK-PK}: 80.632 mV.

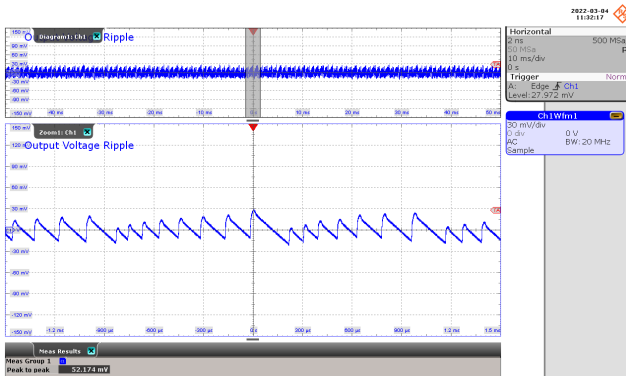

Figure 71 – Output Voltage Ripple Waveforms.
 85 VAC, 80 mA Output.
 Ripple: 30 mV / div., 10 ms / div.
 Zoom: 300 μs / div.
 V_{PK-PK} : 52.174 mV.

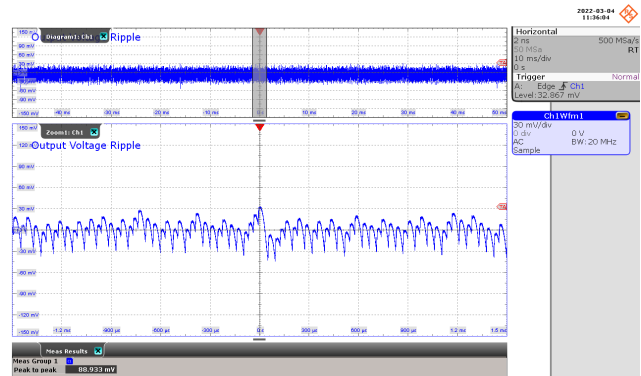

Figure 72 – Output Voltage Ripple Waveforms.
 115 VAC, 800 mA Output.
 Ripple: 30 mV / div., 10 ms / div.
 Zoom: 300 μs / div.
 V_{PK-PK} : 88.933 mV.

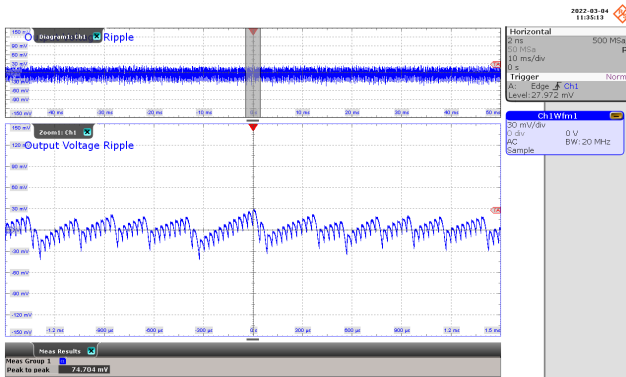

Figure 73 – Output Voltage Ripple Waveforms.
 115 VAC, 600 mA Output.
 Ripple: 30 mV / div., 10 ms / div.
 Zoom: 300 μs / div.
 V_{PK-PK} : 74.704 mV.

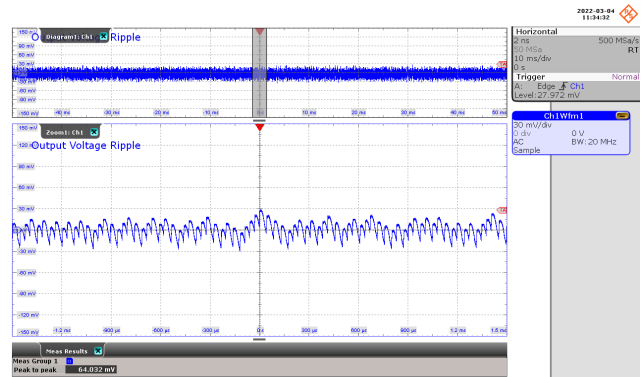

Figure 74 – Output Voltage Ripple Waveforms.
 115 VAC, 400 mA Output.
 Ripple: 30 mV / div., 10 ms / div.
 Zoom: 300 μs / div.
 V_{PK-PK} : 64.032 mV.

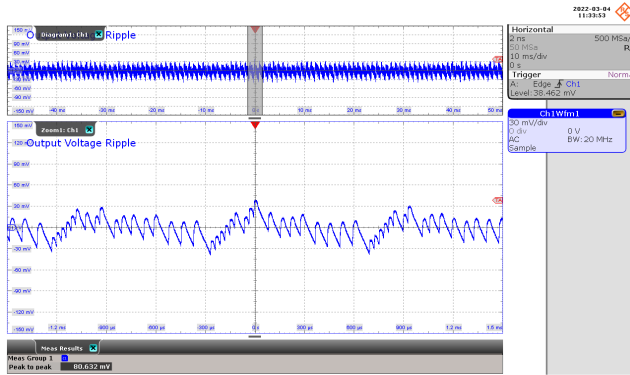

Figure 75 – Output Voltage Ripple Waveforms.
 115 VAC, 200 mA Output.
 Ripple: 30 mV / div., 10 ms / div.
 Zoom: 300 μ s / div.
 V_{PK-PK} : 80.632 mV.

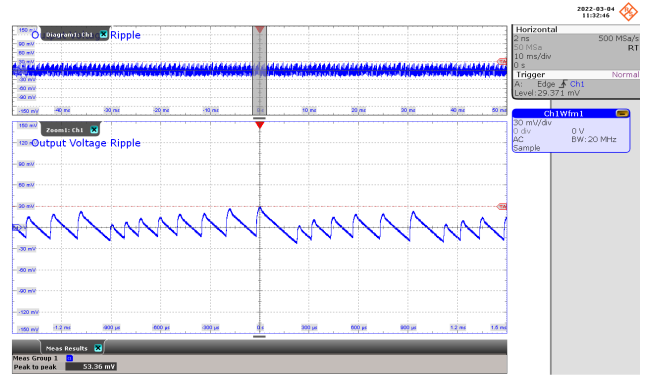

Figure 76 – Output Voltage Ripple Waveforms.
 115 VAC, 80 mA Output.
 Ripple: 30 mV / div., 10 ms / div.
 Zoom: 300 μ s / div.
 V_{PK-PK} : 53.36 mV.

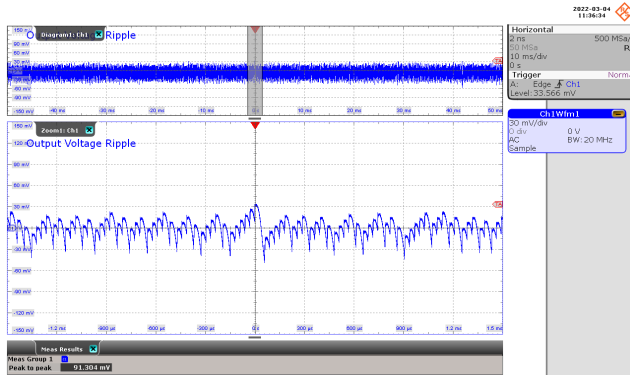

Figure 77 – Output Voltage Ripple Waveforms.
 230 VAC, 800 mA Output.
 Ripple: 30 mV / div., 10 ms / div.
 Zoom: 300 μ s / div.
 V_{PK-PK} : 91.304 mV.

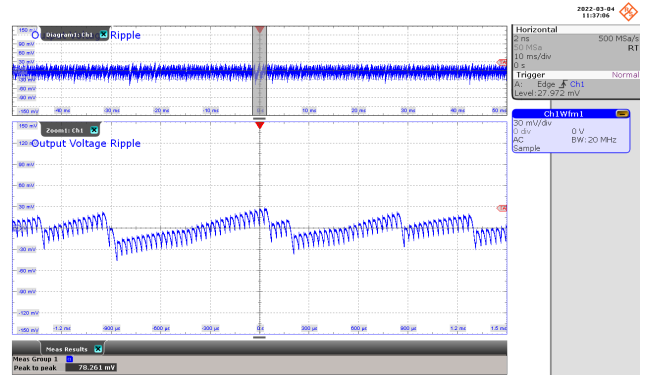

Figure 78 – Output Voltage Ripple Waveforms.
 230 VAC, 600 mA Output.
 Ripple: 30 mV / div., 10 ms / div.
 Zoom: 300 μ s / div.
 V_{PK-PK} : 78.261 mV.

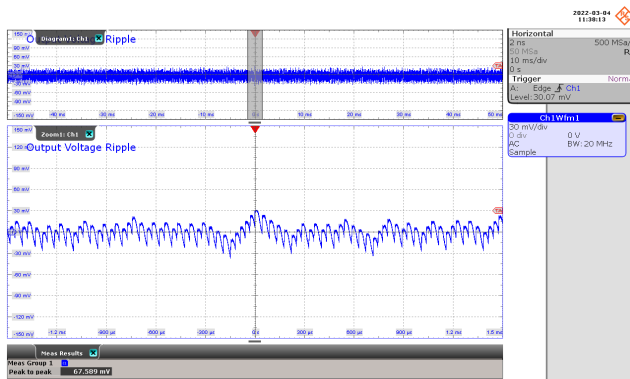

Figure 79 – Output Voltage Ripple Waveforms.
 230 VAC, 400 mA Output.
 Ripple: 30 mV / div., 10 ms / div.
 Zoom: 300 μs / div.
 V_{PK-PK}: 67.589 mV.

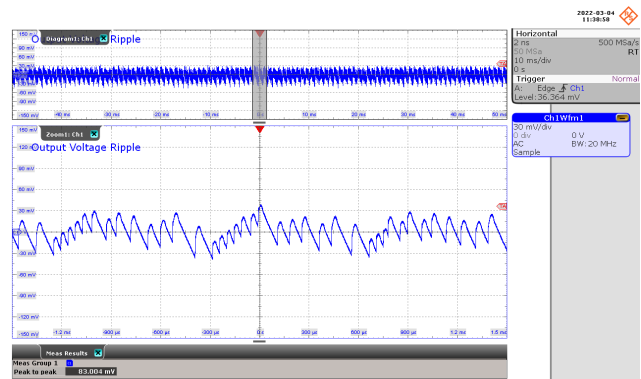

Figure 80 – Output Voltage Ripple Waveforms.
 230 VAC, 200 mA Output.
 Ripple: 30 mV / div., 10 ms / div.
 Zoom: 300 μs / div.
 V_{PK-PK}: 83.004 mV.

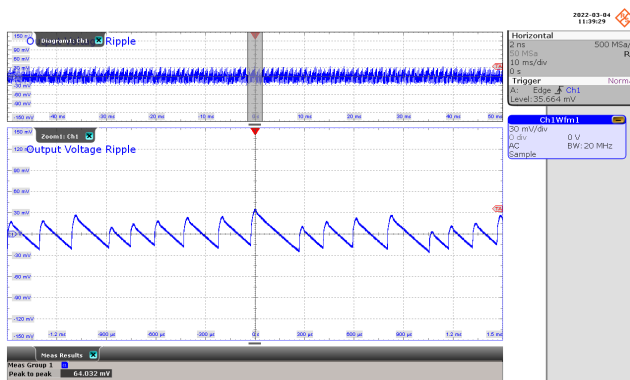

Figure 81 – Output Voltage Ripple Waveforms.
 230 VAC, 80 mA Output.
 Ripple: 30 mV / div., 10 ms / div.
 Zoom: 300 μs / div.
 V_{PK-PK}: 64.032 mV.

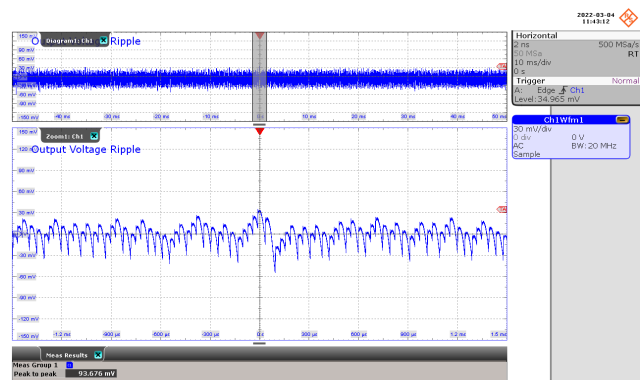

Figure 82 – Output Voltage Ripple Waveforms.
 265 VAC, 800 mA Output.
 Ripple: 30 mV / div., 10 ms / div.
 Zoom: 300 μs / div.
 V_{PK-PK}: 93.676 mV.

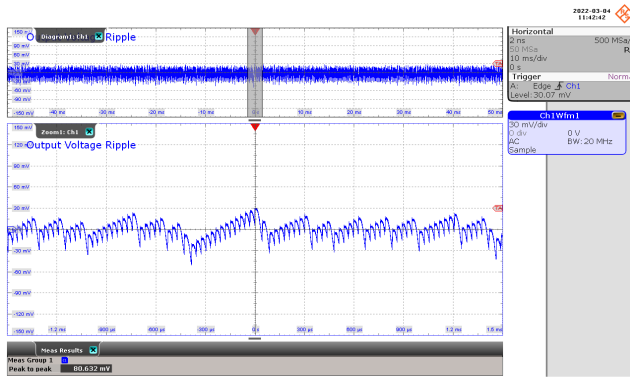

Figure 83 – Output Voltage Ripple Waveforms.
 265 VAC, 600 mA Output.
 Ripple: 30 mV / div., 10 ms / div.
 Zoom: 300 μ s / div.
 V_{PK-PK} : 80.632 mV.

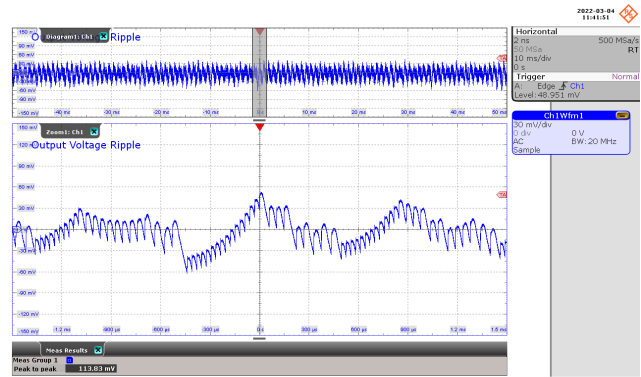

Figure 84 – Output Voltage Ripple Waveforms.
 265 VAC, 400 mA Output.
 Ripple: 30 mV / div., 10 ms / div.
 Zoom: 300 μ s / div.
 V_{PK-PK} : 113.83 mV.

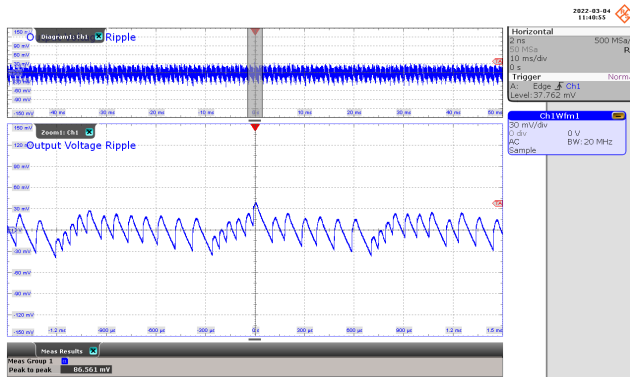

Figure 85 – Output Voltage Ripple Waveforms.
 265 VAC, 200 mA Output.
 Ripple: 30 mV / div., 10 ms / div.
 Zoom: 300 μ s / div.
 V_{PK-PK} : 86.561 mV.

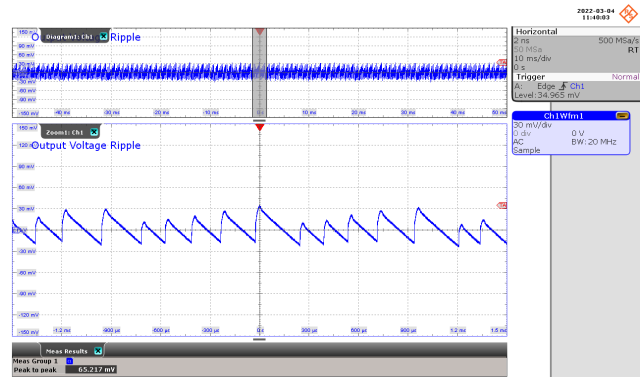

Figure 86 – Output Voltage Ripple Waveforms.
 265 VAC, 80 mA Output.
 Ripple: 30 mV / div., 10 ms / div.
 Zoom: 300 μ s / div.
 V_{PK-PK} : 65.217 mV.

10.3 Transient Response

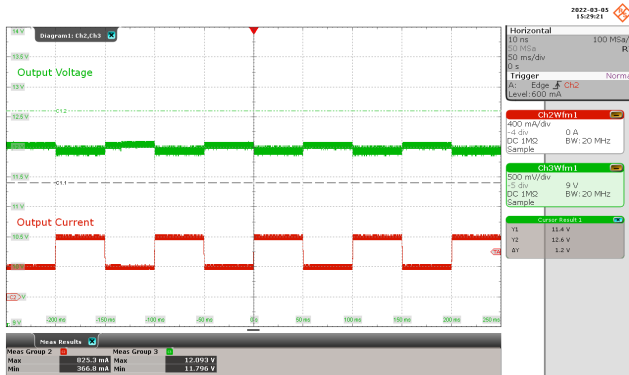

Figure 87 – Transient Output Waveforms. 85 VAC.
 Output Current: 400 mA / div., 50 ms / div.
 Output Voltage: 500 mV / div., 50 ms / div.
 Load Transient: 50 % - 100%.
 Duty Cycle, Slew Rate: 50%, 0.8 A / μs.
 Frequency: 10 Hz.
 V_{MAX} : 12.093 V, V_{MIN} : 11.796 V.

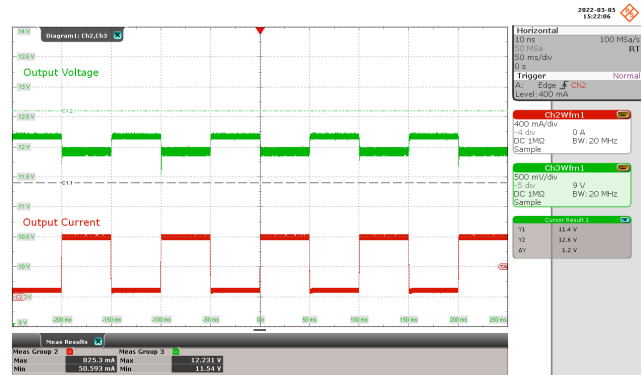

Figure 88 – Transient Output Waveforms. 85 VAC.
 Output Current: 400 mA / div., 50 ms / div.
 Output Voltage: 500 mV / div., 50 ms / div.
 Load Transient: 10 % - 100%.
 Duty Cycle, Slew Rate: 50%, 0.8 A / μs.
 Frequency: 10 Hz.
 V_{MAX} : 12.231 V, V_{MIN} : 11.54 V.

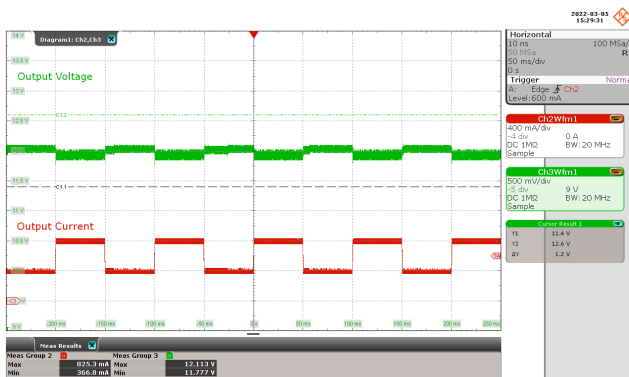

Figure 89 – Transient Output Waveforms. 115 VAC.
 Output Current: 400 mA / div., 50 ms / div.
 Output Voltage: 500 mV / div., 50 ms / div.
 Load Transient: 50 % - 100%.
 Duty Cycle, Slew Rate: 50%, 0.8 A / μs.
 Frequency: 10 Hz.
 V_{MAX} : 12.113 V, V_{MIN} : 11.777 V.

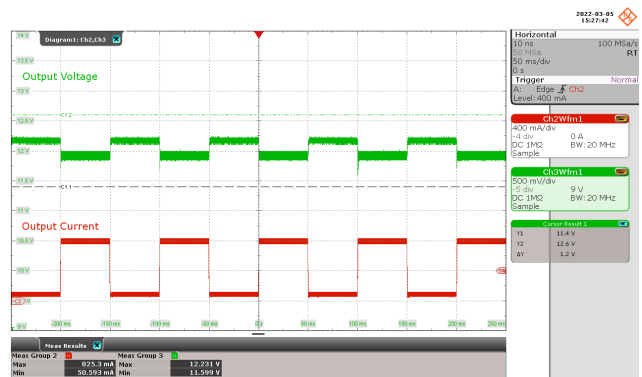

Figure 90 – Transient Output Waveforms. 115 VAC.
 Output Current: 400 mA / div., 50 ms / div.
 Output Voltage: 500 mV / div., 50 ms / div.
 Load Transient: 10 % - 100%.
 Duty Cycle, Slew Rate: 50%, 0.8 A / μs.
 Frequency: 10 Hz.
 V_{MAX} : 12.231 V, V_{MIN} : 11.599 V.

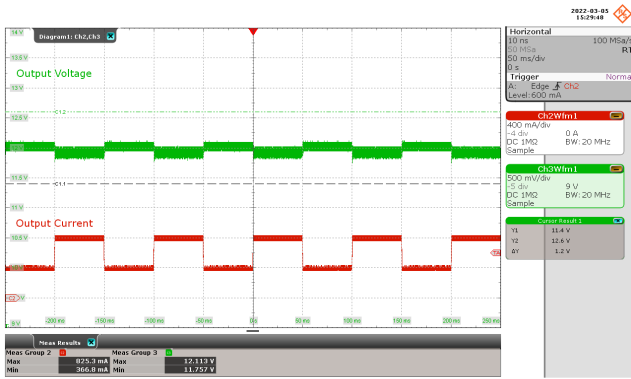

Figure 91 – Transient Output Waveforms.
 230 VAC.
 Output Current: 400 mA / div., 50 ms / div.
 Output Voltage: 500 mV / div., 50 ms / div..
 Load Transient: 50 % - 100%.
 Duty Cycle, Slew Rate: 50%, 0.8 A / μ s.
 Frequency: 10 Hz.
 V_{MAX} : 12.113 V, V_{MIN} : 11.757 V.

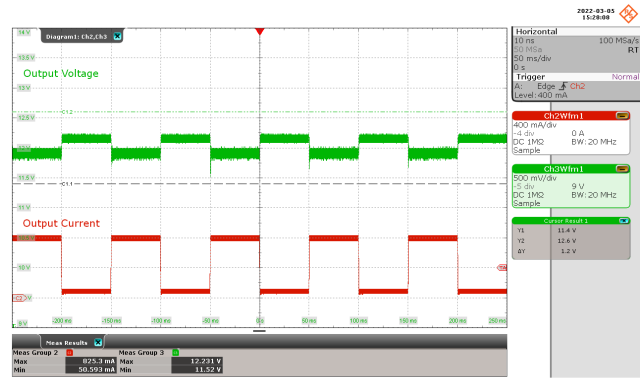

Figure 92 – Transient Output Waveforms.
 230 VAC.
 Output Current: 400 mA / div., 50 ms / div.
 Output Voltage: 500 mV / div., 50 ms / div..
 Load Transient: 10 % - 100%.
 Duty Cycle, Slew Rate: 50%, 0.8 A / μ s.
 Frequency: 10 Hz.
 V_{MAX} : 12.231 V, V_{MIN} : 11.52 V.

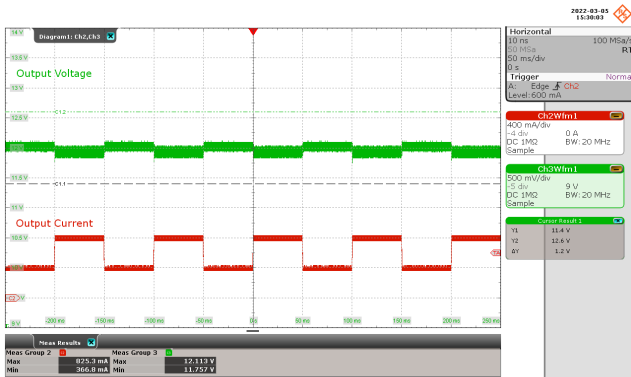

Figure 93 – Transient Output Waveforms.
 265 VAC.
 Output Current: 400 mA / div., 50 ms / div.
 Output Voltage: 500 mV / div., 50 ms / div..
 Load Transient: 50 % - 100%.
 Duty Cycle, Slew Rate: 50%, 0.8 A / μ s.
 Frequency: 10 Hz.
 V_{MAX} : 12.113 V, V_{MIN} : 11.757 V.

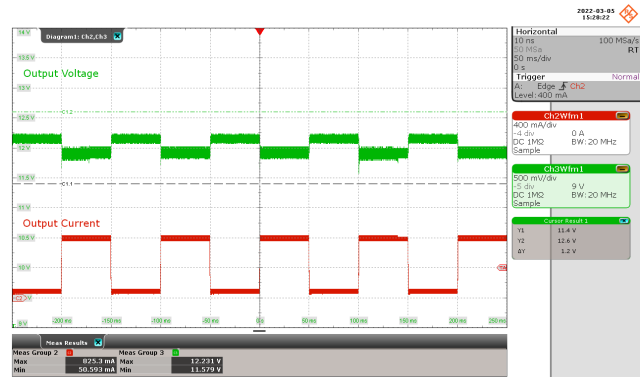

Figure 94 – Transient Output Waveforms.
 265 VAC.
 Output Current: 400 mA / div., 50 ms / div.
 Output Voltage: 500 mV / div., 50 ms / div..
 Load Transient: 10 % - 100%.
 Duty Cycle, Slew Rate: 50%, 0.8 A / μ s.
 Frequency: 10 Hz.
 V_{MAX} : 12.231 V, V_{MIN} : 11.579 V.

11 Conducted EMI

11.1 800 mA Resistive Load, Floating Output (QPK / AV)

After running for 15 minutes.

11.1.1 115 VAC

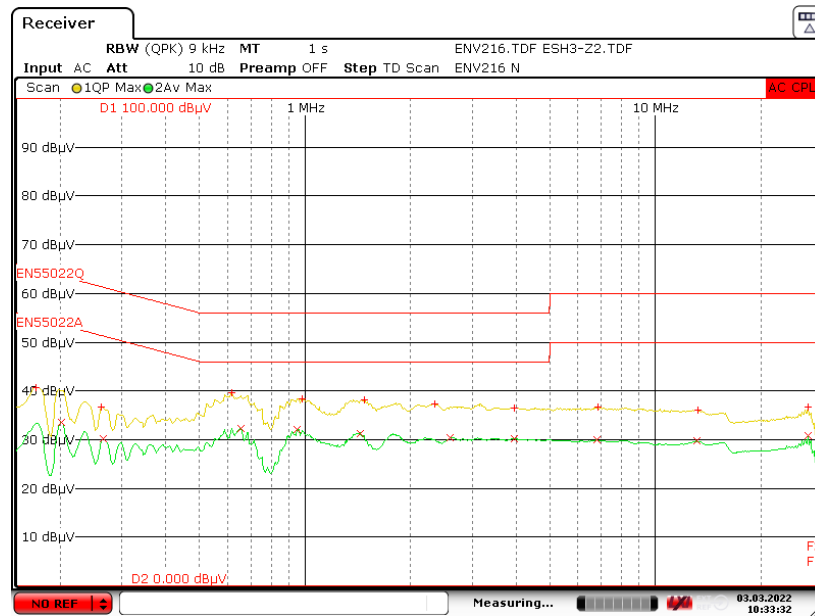

Date: 3.MAR.2022 10:33:33

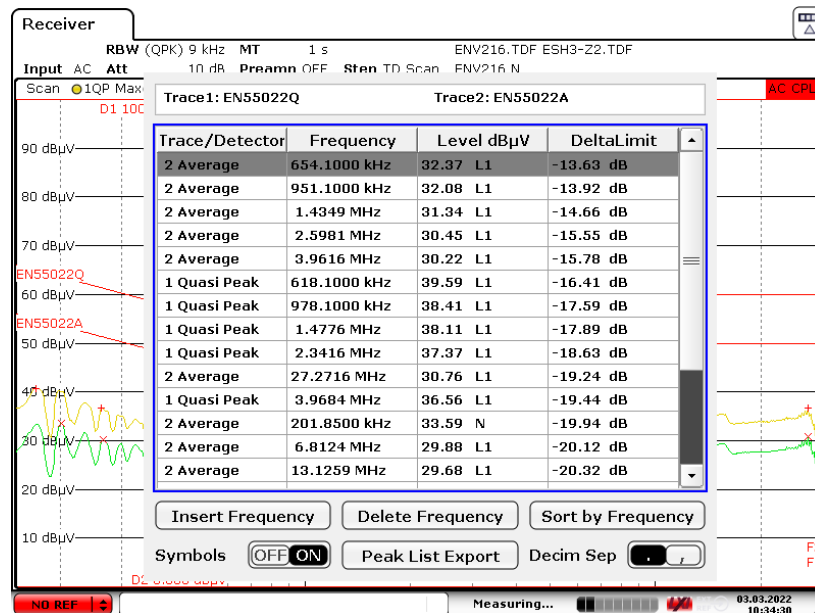

Date: 3.MAR.2022 10:34:30

Figure 95 – 115 VAC Floating Ground EMI.

11.1.2 230 VAC

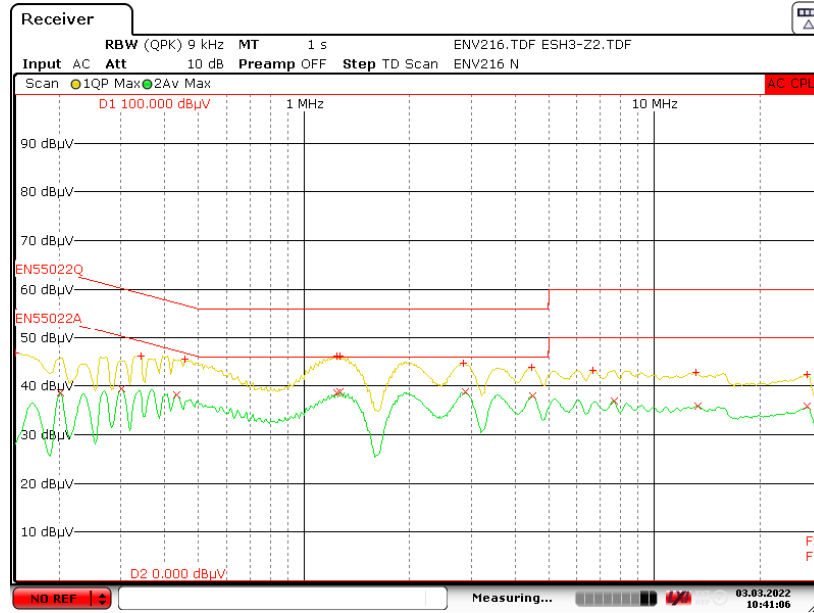

Date: 3.MAR.2022 10:41:07

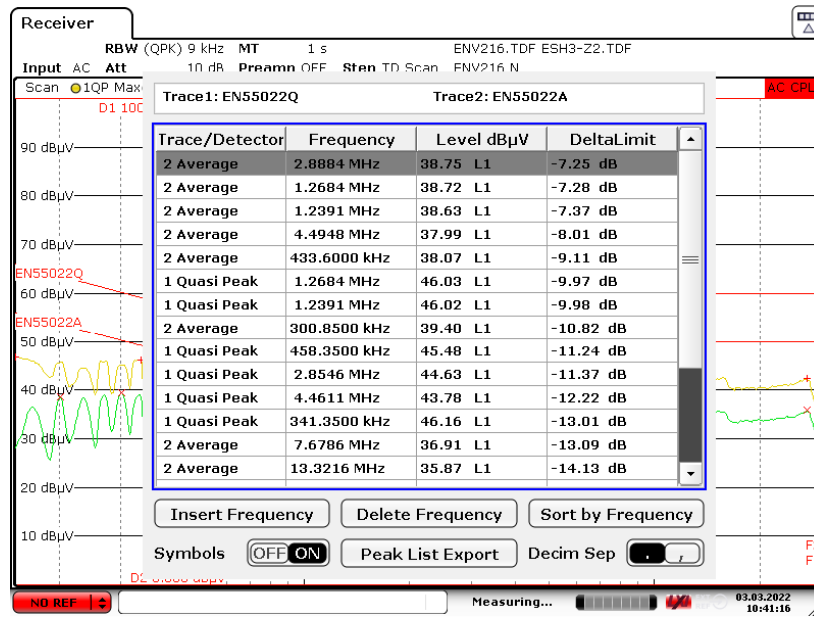

Date: 3.MAR.2022 10:41:17

Figure 96 – 230 VAC Floating Ground.



12 Lightning Surge

12.1 Differential Mode Test

Passed ± 1 kV surge test.

Surge Voltage (kV)	Phase Angle (°)	IEC Coupling	Generator Impedance (Ω)	Number Strikes	Result	Remarks
+1	0	L1/L2	2	10	PASS	No Auto-restart
-1	0	L1/L2	2	10	PASS	No Auto-restart
+1	90	L1/L2	2	10	PASS	No Auto-restart
-1	90	L1/L2	2	10	PASS	No Auto-restart
+1	180	L1/L2	2	10	PASS	No Auto-restart
-1	180	L1/L2	2	10	PASS	No Auto-restart
+1	270	L1/L2	2	10	PASS	No Auto-restart
-1	270	L1/L2	2	10	PASS	No Auto-restart

12.1.1 1000 V 90° Differential Mode Surge



Figure 97 – Drain Voltage, 230 VAC, Full Load.

13 Revision History

Date	Author	Revision	Description & Changes	Reviewed
09-Jun-22	JD / MMT	1.0	Initial Release	Apps & Mktg



For the latest updates, visit our website: www.power.com

Reference Designs are technical proposals concerning how to use Power Integrations' gate drivers in particular applications and/or with certain power modules. These proposals are "as is" and are not subject to any qualification process. The suitability, implementation and qualification are the sole responsibility of the end user. The statements, technical information and recommendations contained herein are believed to be accurate as of the date hereof. All parameters, numbers, values and other technical data included in the technical information were calculated and determined to our best knowledge in accordance with the relevant technical norms (if any). They may be based on assumptions or operational conditions that do not necessarily apply in general. We exclude any representation or warranty, express or implied, in relation to the accuracy or completeness of the statements, technical information and recommendations contained herein. No responsibility is accepted for the accuracy or sufficiency of any of the statements, technical information, recommendations or opinions communicated and any liability for any direct, indirect or consequential loss or damage suffered by any person arising therefrom is expressly disclaimed.

Power Integrations reserves the right to make changes to its products at any time to improve reliability or manufacturability. Power Integrations does not assume any liability arising from the use of any device or circuit described herein. POWER INTEGRATIONS MAKES NO WARRANTY HEREIN AND SPECIFICALLY DISCLAIMS ALL WARRANTIES INCLUDING, WITHOUT LIMITATION, THE IMPLIED WARRANTIES OF MERCHANTABILITY, FITNESS FOR A PARTICULAR PURPOSE, AND NON-INFRINGEMENT OF THIRD PARTY RIGHTS.

Patent Information

The products and applications illustrated herein (including transformer construction and circuits' external to the products) may be covered by one or more U.S. and foreign patents, or potentially by pending U.S. and foreign patent applications assigned to Power Integrations. A complete list of Power Integrations' patents may be found at www.power.com. Power Integrations grants its customers a license under certain patent rights as set forth at www.power.com/ip.htm.

Power Integrations, the Power Integrations logo, CAPZero, ChiPhy, CHY, DPA-Switch, EcoSmart, E-Shield, eSIP, eSOP, HiperPLC, HiperPFS, HiperTFS, InnoSwitch, Innovation in Power Conversion, InSOP, LinkSwitch, LinkZero, LYTSwitch, SENZero, TinySwitch, TOPSwitch, PI, PI Expert, SCALE, SCALE-1, SCALE-2, SCALE-3 and SCALE-iDriver, are trademarks of Power Integrations, Inc. Other trademarks are property of their respective companies. ©2019, Power Integrations, Inc.

Power Integrations Worldwide Sales Support Locations**WORLD HEADQUARTERS**

5245 Hellyer Avenue
San Jose, CA 95138, USA.
Main: +1-408-414-9200
Customer Service:
Worldwide: +1-65-635-64480
Americas: +1-408-414-9621
e-mail: usasales@power.com

CHINA (SHANGHAI)

Rm 2410, Charity Plaza, No. 88,
North Caoxi Road,
Shanghai, PRC 200030
Phone: +86-21-6354-6323
e-mail: chinasales@power.com

CHINA (SHENZHEN)

17/F, Hivac Building, No. 2, Keji
Nan 8th Road, Nanshan District,
Shenzhen, China, 518057
Phone: +86-755-8672-8689
e-mail: chinasales@power.com

GERMANY (AC-DC/LED Sales)

Einsteinring 24
85609 Dornach/Aschheim
Germany
Tel: +49-89-5527-39100
e-mail: eurosales@power.com

GERMANY (Gate Driver Sales)

HellwegForum 1
59469 Ense
Germany
Tel: +49-2938-64-39990
e-mail: igbt-driver.sales@power.com

INDIA

#1, 14th Main Road
Vasanthanagar
Bangalore-560052
India
Phone: +91-80-4113-8020
e-mail: indiasales@power.com

ITALY

Via Milanese 20, 3rd. Fl.
20099 Sesto San Giovanni (MI) Italy
Phone: +39-024-550-8701
e-mail: eurosales@power.com

JAPAN

Yusen Shin-Yokohama 1-chome Bldg.
1-7-9, Shin-Yokohama, Kohoku-ku
Yokohama-shi,
Kanagawa 222-0033 Japan
Phone: +81-45-471-1021
e-mail: japansales@power.com

KOREA

RM 602, 6FL
Korea City Air Terminal B/D,
159-6
Samsung-Dong, Kangnam-Gu,
Seoul, 135-728 Korea
Phone: +82-2-2016-6610
e-mail: koreasales@power.com

SINGAPORE

51 Newton Road,
#19-01/05 Goldhill Plaza
Singapore, 308900
Phone: +65-6358-2160
e-mail: singaporesales@power.com

TAIWAN

5F, No. 318, Nei Hu Rd.,
Sec. 1
Nei Hu District
Taipei 11493, Taiwan R.O.C.
Phone: +886-2-2659-4570
e-mail: taiwansales@power.com

UK

Building 5, Suite 21
The Westbrook Centre
Milton Road
Cambridge
CB4 1YG
Phone: +44 (0) 7823-557484
e-mail: eurosales@power.com

**Power Integrations, Inc.**Tel: +1 408 414 9200 Fax: +1 408 414 9201
www.power.com