

AMY-110-S-C

~18° spot beam. Assembly with holder C compatible with LEDiL HEKLA. Black version.

SPECIFICATION:

Dimensions	Ø 109.7 mm
Height	23.3 mm
ROHS compliant	yes ⓘ



MATERIALS:

Component	Type	Material	Colour	Finish
AMY-110-S	Single lens	PMMA	clear	
AMY-110-HLD-C	Holder C	PC	black	

ORDERING INFORMATION:

Component	Qty in box	MOQ	MPQ	Box weight (kg)
CP18557_AMY-110-S-C » Box size: 480 x 280 x 300 mm	77	77	7	8.6

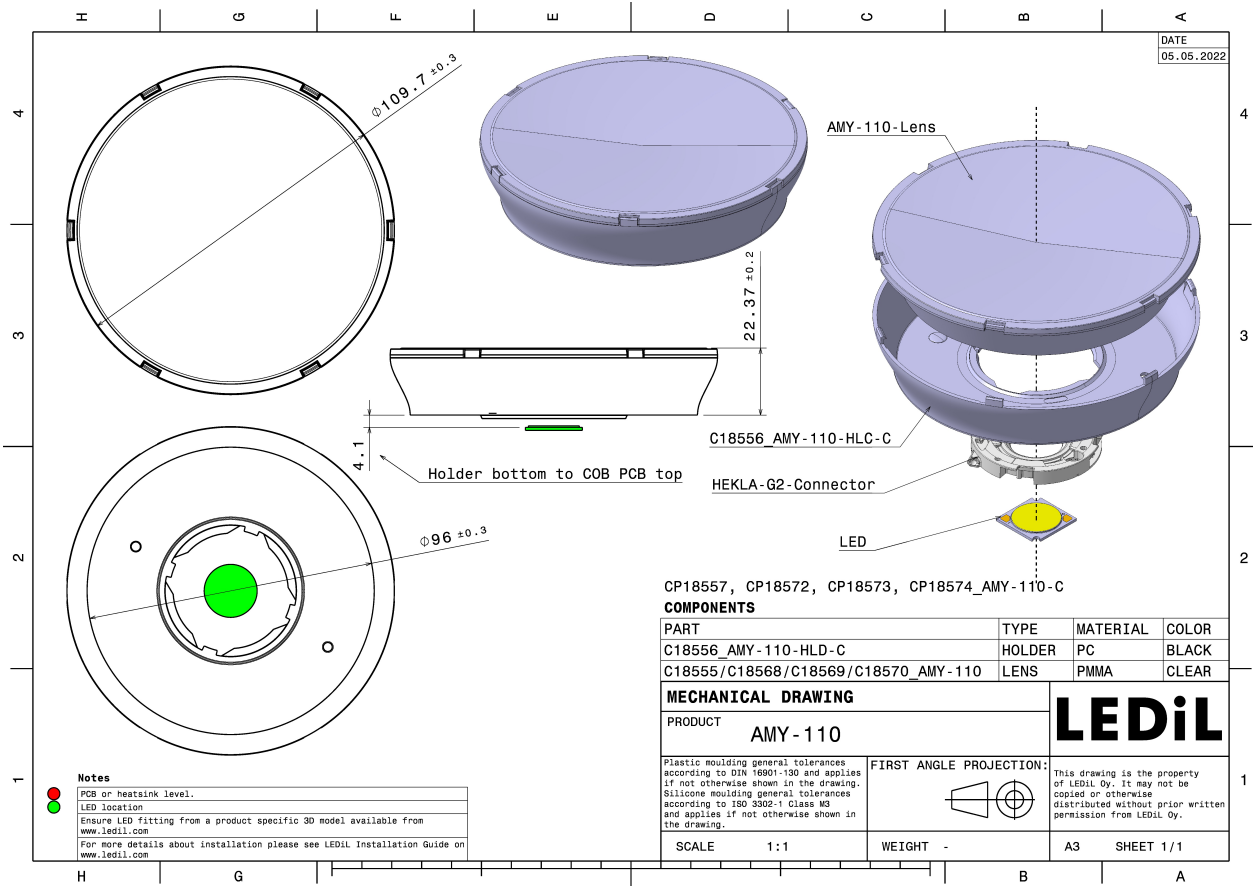

See also our general installation guide: www.ledil.com/installation_guide





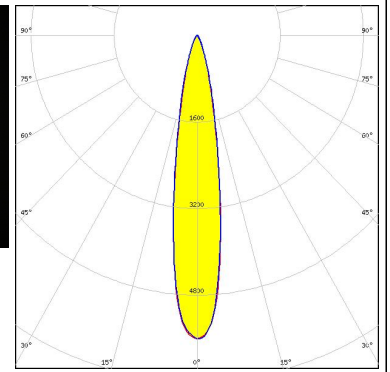
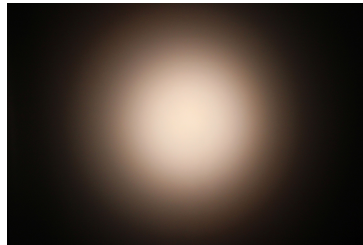

OPTICAL RESULTS (MEASURED):



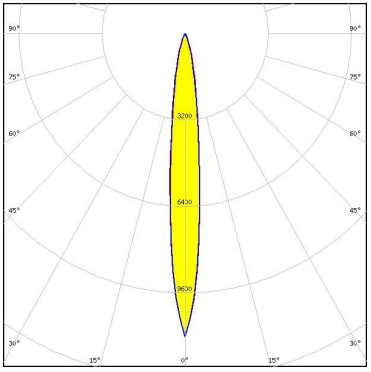

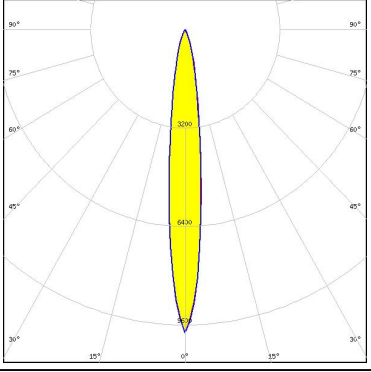

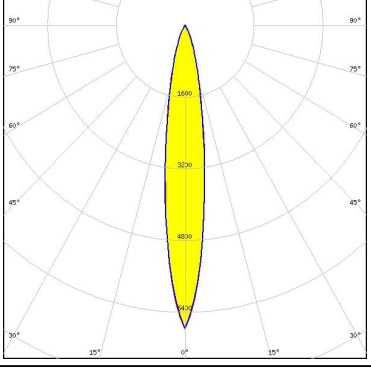

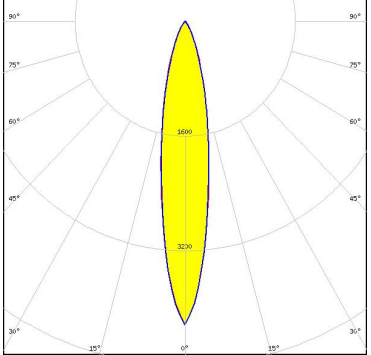
LED CTM-14 (Tunable White) Gen2
FWHM / FWTM 18.0° / 39.0°
Efficiency 91 %
Peak intensity 5.6 cd/lm
LEDs/each optic 1
Light colour Tunable White
Required components:
C16142_HEKLA-SOCKET-K
Bender Wirth: 442 Typ L8



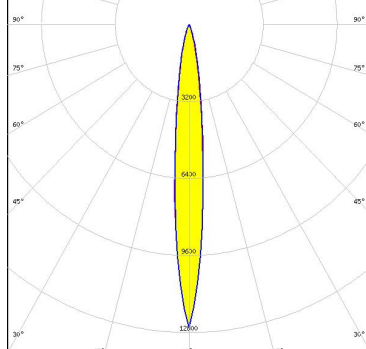

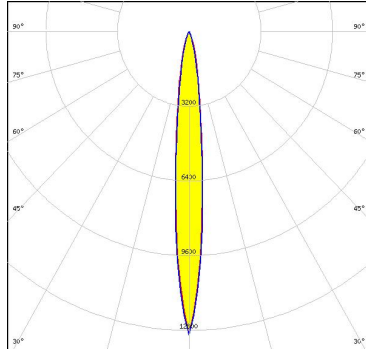

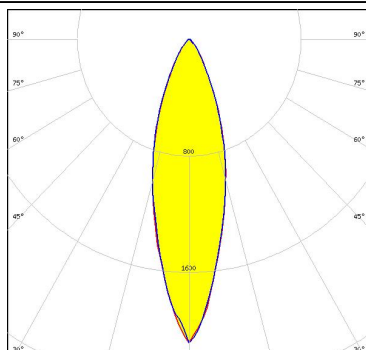

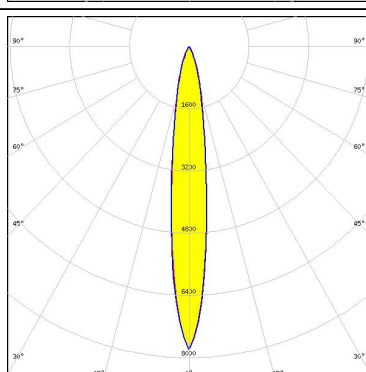
OPTICAL RESULTS (SIMULATED):

<p></p> <p>LED V10 Gen 8 FWHM / FWTM 12.0° / 30.0° Efficiency 94 % Peak intensity 11.2 cd/lm LEDs/each optic 1 Light colour White Required components: F15255_HEKLA-SOCKET-C</p>	
<p></p> <p>LED V11 HD Gen 8 FWHM / FWTM 12.0° / 32.0° Efficiency 94 % Peak intensity 9.9 cd/lm LEDs/each optic 1 Light colour White Required components: F15859_HEKLA-SOCKET-I</p>	
<p></p> <p>LED V13 Gen 8 FWHM / FWTM 16.0° / 38.0° Efficiency 93 % Peak intensity 6.8 cd/lm LEDs/each optic 1 Light colour White Required components: F15859_HEKLA-SOCKET-I</p>	
<p></p> <p>LED V18 Gen 8 FWHM / FWTM 18.0° / 47.0° Efficiency 87 % Peak intensity 4.2 cd/lm LEDs/each optic 1 Light colour White Required components: C16142_HEKLA-SOCKET-K Bender Wirth: 462 Typ L8</p>	

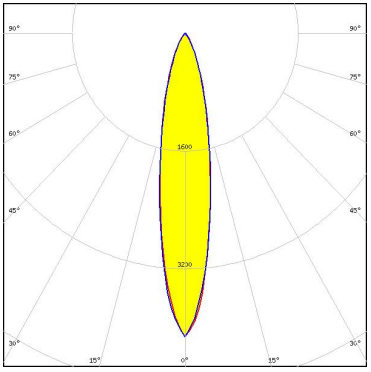

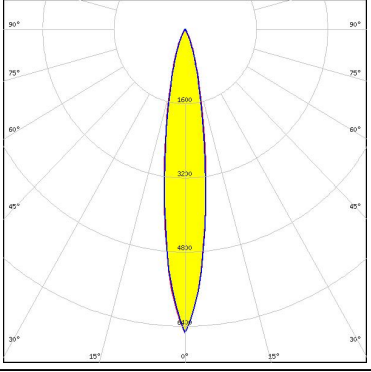

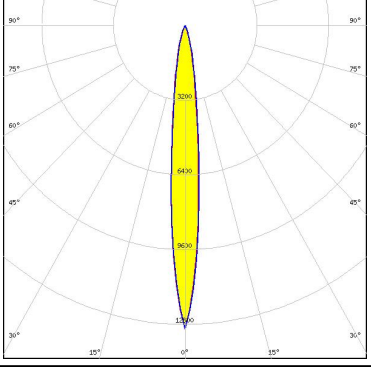
OPTICAL RESULTS (SIMULATED):

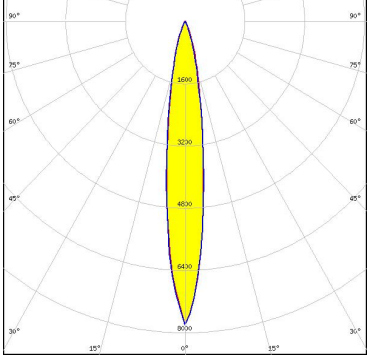
<p></p> <p>LED V8 Gen 8</p> <p>FWHM / FWTM 12.0° / 28.0°</p> <p>Efficiency 94 %</p> <p>Peak intensity 12.6 cd/lm</p> <p>LEDs/each optic 1</p> <p>Light colour White</p> <p>Required components: F15253_HEKLA-SOCKET-A</p>	
<p></p> <p>LED V9 HD Gen 8</p> <p>FWHM / FWTM 10.0° / 28.0°</p> <p>Efficiency 94 %</p> <p>Peak intensity 13 cd/lm</p> <p>LEDs/each optic 1</p> <p>Light colour White</p> <p>Required components: F15859_HEKLA-SOCKET-I</p>	
<p></p> <p>LED Vero SE 29</p> <p>FWHM / FWTM 29.0° / 64.0°</p> <p>Efficiency 82 %</p> <p>Peak intensity 2.1 cd/lm</p> <p>LEDs/each optic 1</p> <p>Light colour White</p> <p>Required components:</p>	
<p></p> <p>LED VERO13</p> <p>FWHM / FWTM 14.0° / 37.0 + 36.0°</p> <p>Efficiency 94 %</p> <p>Peak intensity 7.8 cd/lm</p> <p>LEDs/each optic 1</p> <p>Light colour White</p> <p>Required components: C16142_HEKLA-SOCKET-K</p>	

OPTICAL RESULTS (SIMULATED):

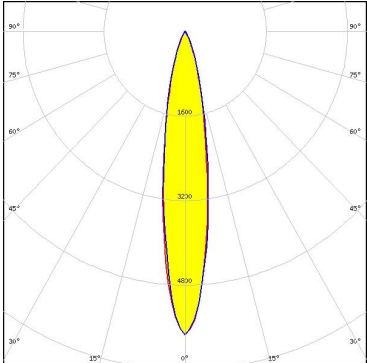
<p></p> <p>LED: VERO18 FWHM / FWTM: 20.0° / 50.0 + 49.0° Efficiency: 93 % Peak intensity: 4.1 cd/lm LEDs/each optic: 1 Light colour: White Required components: C16142_HEKLA-SOCKET-K</p>	
<p></p> <p>LED: Vesta DTW 15mm (33W) FWHM / FWTM: 16.0° / 40.0 + 39.0° Efficiency: 93 % Peak intensity: 6.5 cd/lm LEDs/each optic: 1 Light colour: White Required components: Bender Wirth: 632b Hekla XL</p>	
<p></p> <p>LED: Vesta DTW 9mm (4W/6W/12W) FWHM / FWTM: 10.0 + 11.0° / 28.0° Efficiency: 94 % Peak intensity: 13 cd/lm LEDs/each optic: 1 Light colour: White Required components: Bender Wirth: 652b Hekla</p>	
<p></p> <p>LED: Vesta TW 13mm (18W) DP FWHM / FWTM: 14.0° / 36.0 + 34.0° Efficiency: 92 % Peak intensity: 7.8 cd/lm LEDs/each optic: 1 Light colour: Tunable White Required components: C16142_HEKLA-SOCKET-K Bender Wirth: 492 Typ L8</p>	

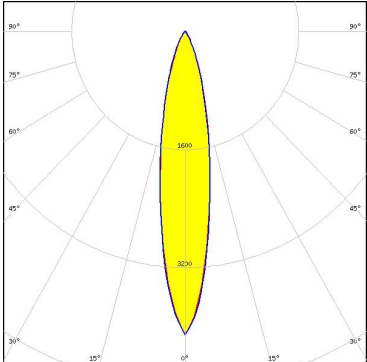
OPTICAL RESULTS (SIMULATED):

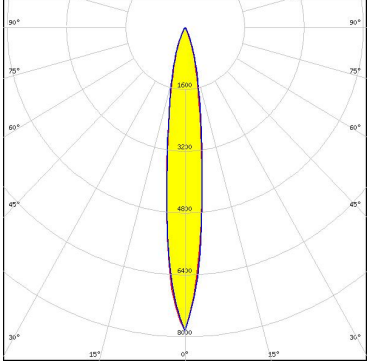
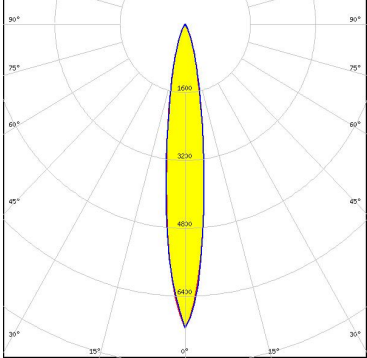
<p></p> <p>LED Vesta TW 15mm DP</p> <p>FWHM / FWTM 18.0° / 41.0°</p> <p>Efficiency 92 %</p> <p>Peak intensity 5.7 cd/lm</p> <p>LEDs/each optic 1</p> <p>Light colour Tunable White</p> <p>Required components: C16142_HEKLA-SOCKET-K Bender Wirth: 482 Typ L8</p>	
<p></p> <p>LED Vesta TW 18mm (31W) DP</p> <p>FWHM / FWTM 20.0° / 48.0°</p> <p>Efficiency 86 %</p> <p>Peak intensity 4.1 cd/lm</p> <p>LEDs/each optic 1</p> <p>Light colour Tunable White</p> <p>Required components: C16142_HEKLA-SOCKET-K Bender Wirth: 462 Typ L8</p>	
<p></p> <p>LED Vesta TW 9mm (9W) DP</p> <p>FWHM / FWTM 14.0° / 37.0 + 38.0°</p> <p>Efficiency 94 %</p> <p>Peak intensity 7.9 cd/lm</p> <p>LEDs/each optic 1</p> <p>Light colour Tunable White</p> <p>Required components: C16142_HEKLA-SOCKET-K Bender Wirth: 489 Typ L8</p>	
<p>CITIZEN</p> <p>LED CLL03x/CLU03x</p> <p>FWHM / FWTM 14.0° / 36.0°</p> <p>Efficiency 92 %</p> <p>Peak intensity 7.1 cd/lm</p> <p>LEDs/each optic 1</p> <p>Light colour White</p> <p>Required components: F17438_HEKLA-G2-I</p>	

OPTICAL RESULTS (SIMULATED):

LUMILEDS

LED LUXEON CoB 1204/1205
 FWHM / FWTM 14.0° / 35.0 + 36.0°
 Efficiency 94 %
 Peak intensity 8.1 cd/lm
 LEDs/each optic 1
 Light colour White
 Required components:
 Bender Wirth: 632a Hekla XL

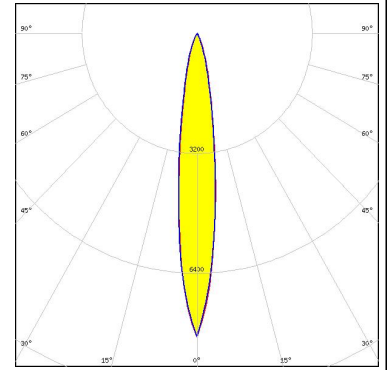

LUMILEDS

LED LUXEON CoB 1205HD
 FWHM / FWTM 12.0° / 32.0°
 Efficiency 94 %
 Peak intensity 9.9 cd/lm
 LEDs/each optic 1
 Light colour White
 Required components:
 F15858_HEKLA-SOCKET-H

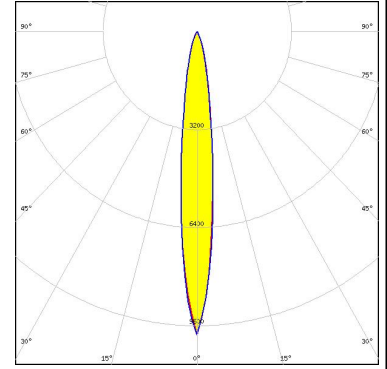

LUMILEDS

LED LUXEON CoB 1208
 FWHM / FWTM 16.0° / 40.0 + 39.0°
 Efficiency 93 %
 Peak intensity 6.5 cd/lm
 LEDs/each optic 1
 Light colour White
 Required components:
 Bender Wirth: 632a Hekla XL

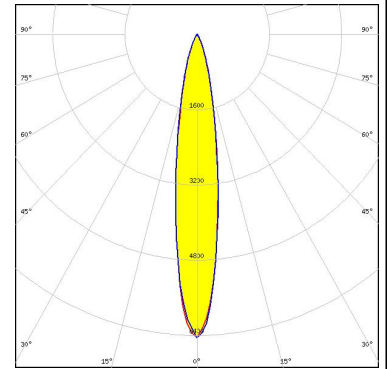

LUMILEDS

LED LUXEON CoB 1211
 FWHM / FWTM 20.0° / 49.0 + 48.0°
 Efficiency 92 %
 Peak intensity 4.1 cd/lm
 LEDs/each optic 1
 Light colour White
 Required components:
 Bender Wirth: 631b Hekla XL

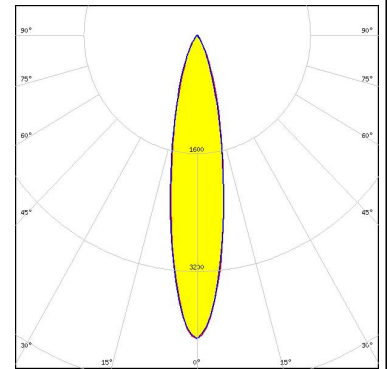

OPTICAL RESULTS (SIMULATED):

LUMILEDS

LED LUXEON CoB 1213/1216/1812
FWHM / FWTM 23.0 + 22.0° / 56.0 + 57.0°
Efficiency 84 %
Peak intensity 2.9 cd/lm
LEDs/each optic 1
Light colour White
Required components:
Bender Wirth: 631b Hekla XL

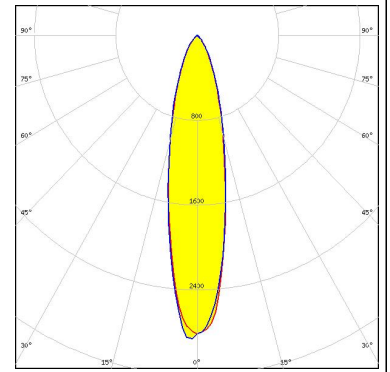

SAMSUNG

LED LC016D / LC019D / LC026D / LC033D
FWHM / FWTM 16.0° / 40.0°
Efficiency 92 %
Peak intensity 6.4 cd/lm
LEDs/each optic 1
Light colour White
Required components:
F17438_HEKLA-G2-I

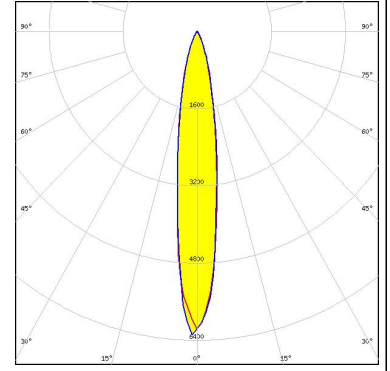

GENERAL INFORMATION:

NOTE: The typical beam angle will be changed by different color, chip size and chip position tolerance. The typical total beam angle is the full angle measured where the luminous intensity is half of the peak value.

Due to use of high power COB's with this product, special attention to proper thermal design is highly recommended. LEDiL has no liability for direct, indirect or consecutive damages arising from the LEDiL products being used outside of the recommended temperature range.

MATERIALS:

As part of our continuous research and improvement processes, and to ensure the best possible quality and availability of our products, LEDiL reserves the right to change material grades without notice.

PRODUCT DATA USER AGREEMENT AND DISCLAIMER:

The measured data in the provided downloadable LEDiL Product Datasheets and Mechanical 2D-Drawings is rounded and provided as reference for planning. LEDiL Oy's optical specifications have been verified by conducting performance testing of the products in accordance with the company's quality system. The reported data are averaged results of multiple measurements with typical variation. LEDiL Oy reserves the right to without prior notification make changes and improvements to its products.

LEDiL Oy assumes neither warranty, nor guarantee nor any other liability of any kind for the contents and correctness of the provided data. The provided data has been generated with highest diligence but the provided data may in reality not represent the complete possible variation range of all intrinsic parameters. Therefore, in certain cases a deviation from the provided data could occur.

LEDiL Oy reserves the right to undertake technical changes of its products without further notification which could lead to changes in the provided data. LEDiL Oy assumes no liability of any kind for the possible deviation from any provided data or any other damage resulting from the usage of the provided data.

The user agrees to this disclaimer and user agreement with the download or usage of the provided files.

LEDiL Oy

Joensuunkatu 13
FI-24240 SALO
Finland

LEDiL Inc.

228 West Page Street
Suite D
Sycamore IL 60178
USA

Ledil Optics Technology (Shenzhen) Co., Ltd.

405 , Block B
Casic Motor Building
Shenzhen 518057
P.R.CHINA

Local sales and technical support

[www.ledil.com/
where_to_buy](http://www.ledil.com/where_to_buy)

Shipping locations

Salo, Finland
Hong Kong, China

Distribution Partners

[www.ledil.com/
where_to_buy](http://www.ledil.com/where_to_buy)