

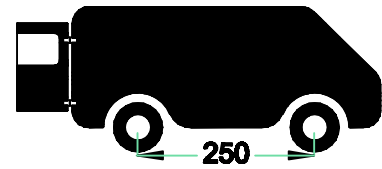

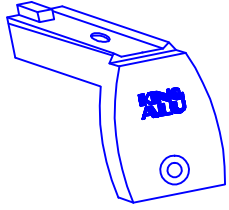

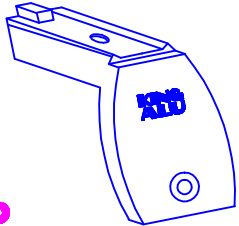

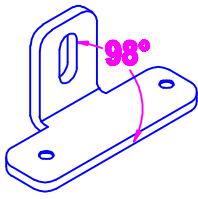
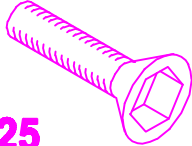
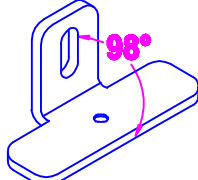

# Ford Courier 2014

210x123 cm. L1

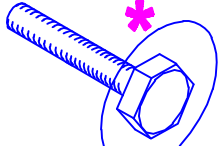

 <b>2x</b>	 <b>2x</b>	 <b>2x</b>
 <b>4x</b>	 <b>2x</b>	 <a href="http://www.kingping.nl">www.kingping.nl</a> <a href="mailto:info@kingping.nl">info@kingping.nl</a>
 <b>8x</b>	 <b>8x</b>	
 <b>6x</b>	 <b>6x</b>	
 <b>2x</b>	 <b>6x</b>	
	 <b>2x</b>	

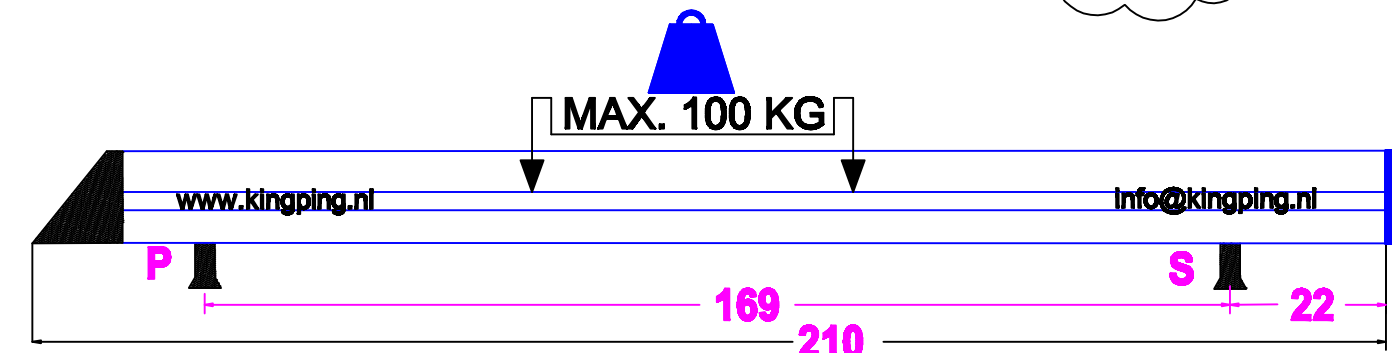
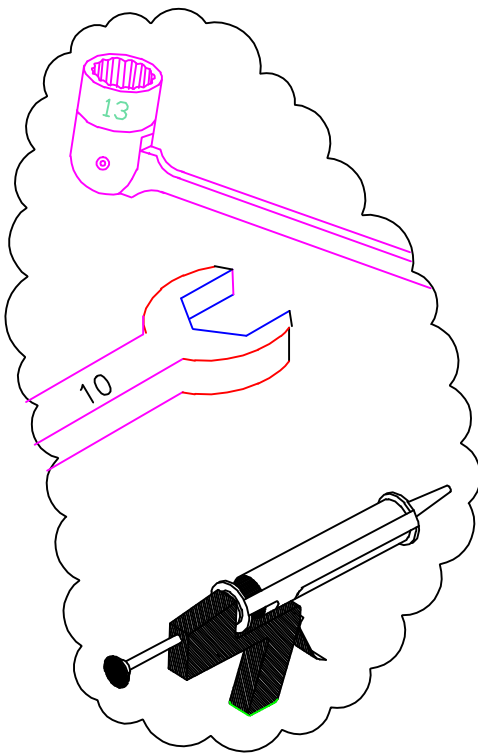

2011 ALU FCKD210123X 08/2015



## MONTAGEFILM KING-ALU IMPERIAAL

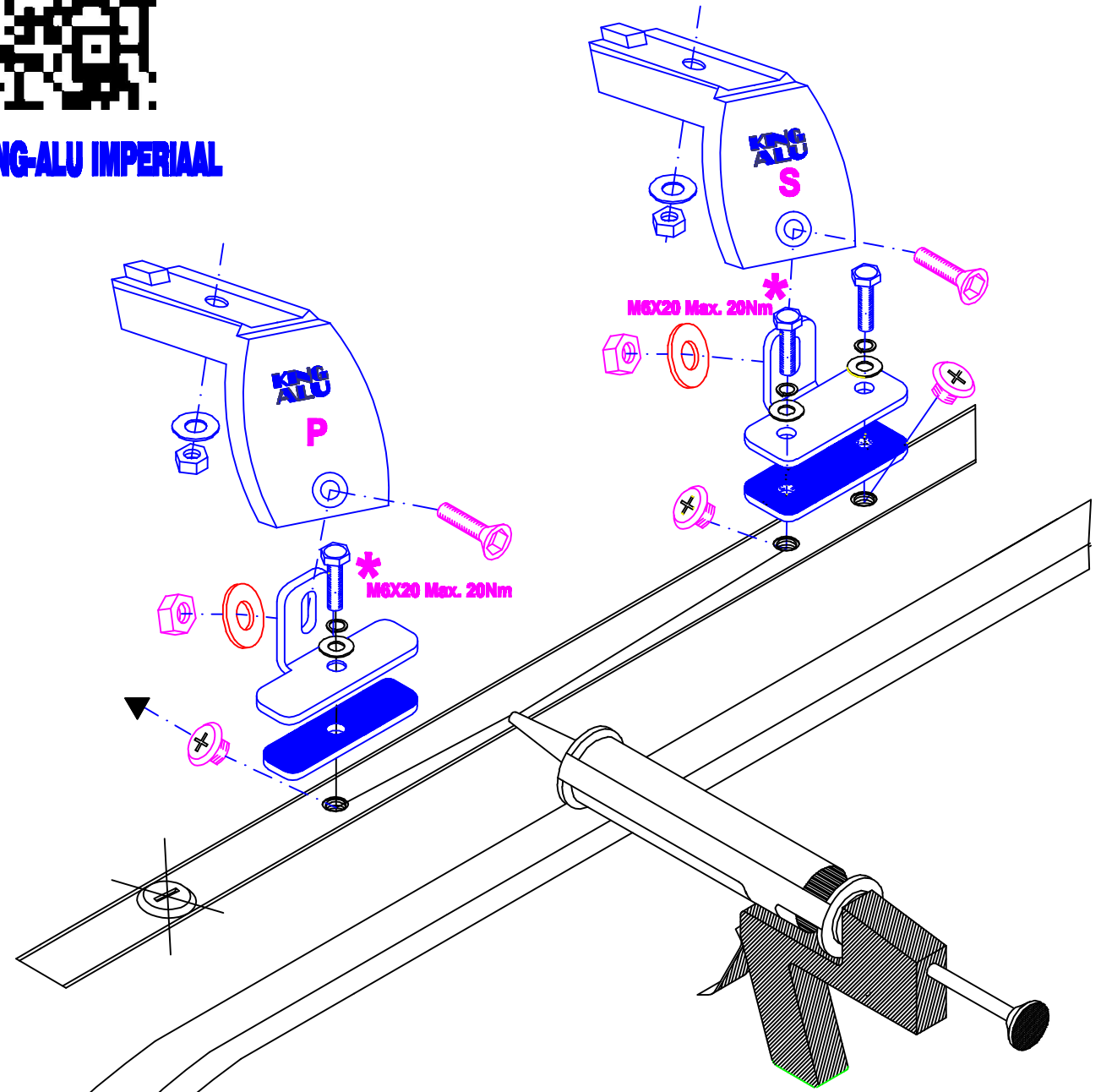

- Bij onduidelijkheden raadpleeg uw leverancier!
- Pour plus de renseignements consultez votre fournisseur!
- Bei eventuellen Unklarheiten, bitten wir Sie mit Ihren Lieferanten Kontakt aufzunehmen!
- Might this not be clear, please contact your supplier!