

FELLER GMBH

A-2525 GUENSELSDORF, AUSTRIA - TEL.: .. 43(2256) 62 32 50 - FAX: .. 43 (2256) 62 32 57
e-mail: sales@feller-at.com <http://www.feller-at.com>

Description: VIIG-H05VVF3G075-C5/2,00M GR7032

Rating of cord set: 2,5A/250Vac

cordset approval: KTL

1. PLUG: Type VIIG

Molded plug according to : IEC60884, CEE (7) VII, KSC8305
Rated current and voltage : 16A, 250 V AC
Plugbase : thermoplastic Polyester(PBTP) 30% GF
Construction : double insulated
Pins : brass, nickel-plated, crimped
Pins outer diameter : 4,8 mm
Outer mold : PVC compound, hardness Shore A75-77
Approvals : VDE, ÖVE, CEBEC, KEMA, S-INTERTEK, D, N, FI, LCIE, IMQ, EAC, KTL, SNI
SCIP database : 60f3e2d1-0a06-4272-8901-d04d26aec79

2. CORD: Type H05VVF3G075 mm²

BLACK

Flexible cord according to : EN50525-1, EN50525-2-11, EN50395, EN50396, AS3191
Marked : *JF*<ÖVE><HAR>H05VVF3G0,75mm2*N1095*CE * CCC 60227
IEC 53 (RVV) 300/500V 3x0,75mm2 * KTL SW01001-2001
* SNI MARK * SNI 04-6629.5 Cu/PVC/PVC-f
Number of cores : 3
Conductor construction : 23 x 0,20 mm O.D. 1,09 mm
Conductor insulation : Extruded PVC, O.D. 2,30 mm
Jacket : Extruded PVC, O.D. 6,60 mm +/- 0,20mm
Temperature rating : -20°C up to +70°C
Resistance of conductors : max. 26 Ω/km
Dielectric strength : 2kVac, 1min.
Insulation resistance : >0,010 MΩ/km
Color of conductors : yellow/green, brown, blue
Approvals : HARMONIZED, ÖVE, KTL, SNI

3. CONNECTOR: Type C5

Molded connector according to : EN/IEC 60320/C5
Rated current and voltage : 2,5 A, 250 V AC
Construction : double insulation, contacts crimped
Contacts of the connection : phosphor bronze CuSn6
Inner insulation : PPO GFR
Outer mold : PVC compound, hardness Shore A 75-77
Approvals : CE, ENEC, KTL

Environmental conformity

: EU-Directive 2012/19/EU (WEEE)
EU-Directive 2011/65/EU
EU-Directive 1907/2006 EG (REACH -compliant)

TESTING

Electrical testing : 100%
Visual inspection : 100%
High pot test wire to wire : 3kVac for 2 sec.
Continuity test : 25Aac to grounding / 20Aac to line and neutral
Polarity test : yes
Skin high pot test : 6kVac line to skin

design subject to change without prior notice, except written agreements with customer

DATE of ISSUE:	May, 2023
REV:	ORIG: DG

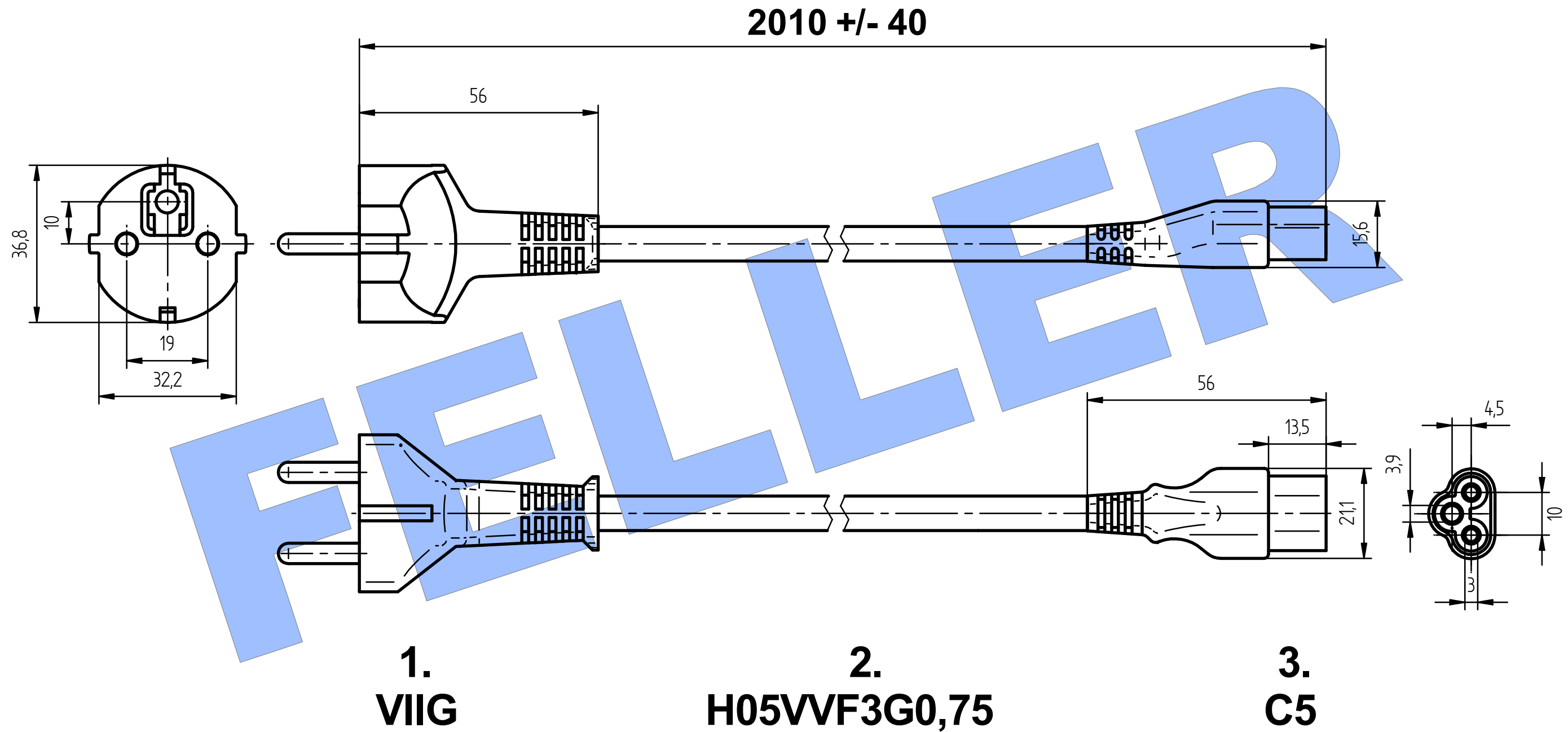

Feller Type: VIIG-H05VVF3G075-C5/2,00M GR7032

All dimensions in mm

23.05.2023 **DG**

RoHS compliant

FELLER 

A-2525 Günselsdorf, Austria
 Telefon 0043-2256-62325-0
 Fax: 0043-2256-62325-7
 email: sales@feller-at.com
<http://www.feller-at.com>