



Part no.: 50122576
FT5.3/2N
Energetic diffuse sensor



Figure can vary

Contents

- . Technical data
- . Dimensioned drawings
- . Electrical connection
- . Diagrams
- . Operation and display
- . Part number code
- . Notes
- . Accessories

Part no.: 50122576 – FT5.3/2N – Energetic diffuse sensor

Technical data

| Basic data | |
|-------------------------------------|---|
| Series | 5 |
| Operating principle | Diffuse reflection principle |
| Optical data | |
| Operating range | Guaranteed operating range |
| Operating range, white 90% | 0.001 ... 0.215 m |
| Operating range, gray 50% | 0.001 ... 0.19 m |
| Operating range, gray 18% | 0.003 ... 0.15 m |
| Operating range, black 6% | 0.003 ... 0.125 m |
| Operating range limit | Typical operating range |
| Operating range limit, white 90% | 0 ... 0.28 m |
| Operating range limit, gray 50% | 0.001 ... 0.245 m |
| Operating range limit, gray 18% | 0.003 ... 0.19 m |
| Operating range limit, black 6% | 0.001 ... 0.16 m |
| Light source | LED , Red |
| LED light wavelength | 620 nm |
| Transmitted-signal shape | Pulsed |
| LED group | Exempt group (in acc. with EN 62471) |
| Electrical data | |
| Protective circuit | Polarity reversal protection Short circuit protected |
| Performance data | |
| Supply voltage U_B | 10 ... 30 V , DC , Incl. residual ripple |
| Residual ripple | 0 ... 15 % , From U_B |
| Open-circuit current | 0 ... 20 mA |
| Outputs | |
| Number of digital switching outputs | 2 Piece(s) |
| Switching outputs | |
| Voltage type | DC |
| Switching current, max. | 100 mA |
| Switching voltage | high: $\geq(U_B-2.5V)$ low: $\leq 2.5V$ |
| Switching output 1 | |
| Switching element | Transistor , NPN |
| Switching principle | Light switching |
| Switching output 2 | |
| Switching element | Transistor , NPN |
| Switching principle | Dark switching |
| Timing | |
| Switching frequency | 500 Hz |
| Response time | 1 ms |
| Readiness delay | 300 ms |
| Connection | |

Part no.: 50122576 – FT5.3/2N – Energetic diffuse sensor

Connection 1

| | |
|----------------------|------------------------------|
| Function | Signal OUT Voltage supply |
| Type of connection | Cable |
| Cable length | 2,000 mm |
| Sheathing material | PUR |
| Cable color | Black |
| Number of conductors | 4 -wire |
| Wire cross section | 0.2 mm ² |

Mechanical data

| | |
|-----------------------|---------------------------|
| Dimension (W x H x L) | 14 mm x 32.5 mm x 20.2 mm |
| Housing material | Plastic , ABS |
| Lens cover material | Plastic |
| Net weight | 70 g |
| Housing color | Black Red |

Operation and display

| | |
|----------------------|--------------|
| Type of display | LED |
| Number of LEDs | 2 Piece(s) |
| Operational controls | Teach button |

Environmental data

| | |
|--------------------------------|---------------|
| Ambient temperature, operation | -40 ... 60 °C |
| Ambient temperature, storage | -40 ... 70 °C |

Certifications

| | |
|----------------------|---------------|
| Degree of protection | IP 67 |
| Protection class | III |
| Certifications | c UL US |
| Standards applied | IEC 60947-5-2 |

Classification

| | |
|-----------------------|----------|
| Customs tariff number | 85365019 |
| eCl@ss 8.0 | 27270903 |
| eCl@ss 9.0 | 27270903 |
| ETIM 5.0 | EC001821 |
| ETIM 6.0 | EC001821 |

Dimensioned drawings

All dimensions in millimeters

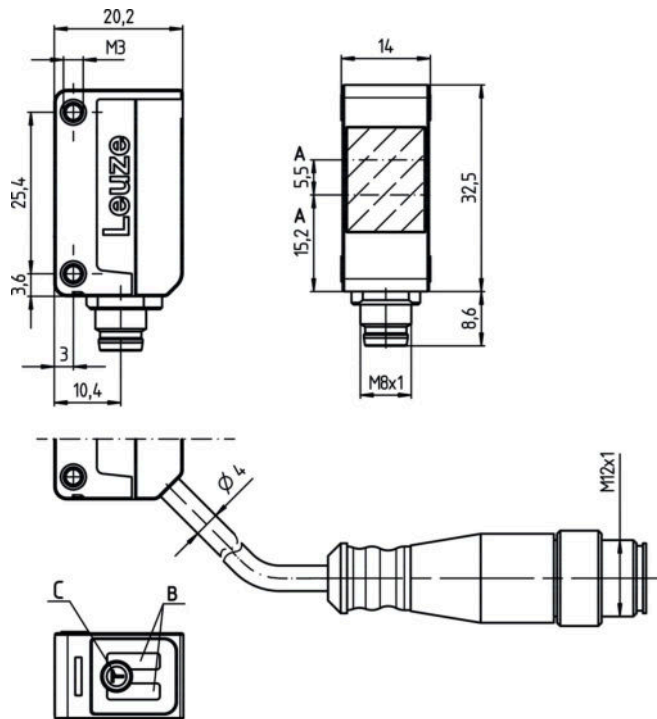

A Optical axis
 B Indicator diode
 C Teach button

Electrical connection

| Connection 1 | |
|----------------------|------------------------------|
| Function | Signal OUT Voltage supply |
| Type of connection | Cable |
| Cable length | 2,000 mm |
| Sheathing material | PUR |
| Cable color | Black |
| Number of conductors | 4 -wire |
| Wire cross section | 0.2 mm ² |

| Conductor color | Conductor assignment |
|-----------------|----------------------|
| Brown | V+ |
| White | OUT 2 |
| Blue | GND |
| Black | OUT 1 |

Diagrams

Typ. black/white behavior

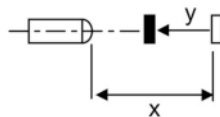
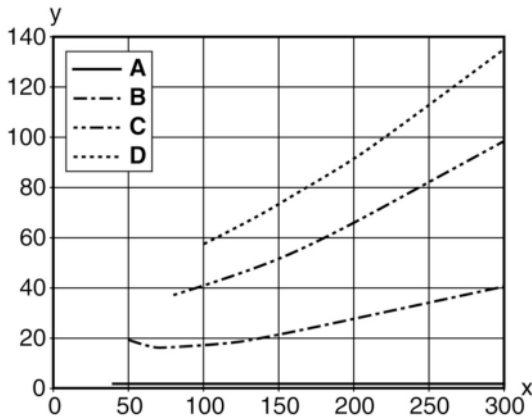

- x Range [mm]
- y Reduction of range [mm]
- A White 90%
- B Gray 50%
- C Gray 18%
- D Black 6%

Fading: black/white error < 50 %

The black/white error is calculated from the operating range against white and the reduction of the operating range against black:

black/white error = reduction of the operating range against black / operating range against white x 100%

Operation and display

LEDs

| LED | Display | Meaning |
|-----|--------------------------|-----------------------|
| 1 | Yellow, continuous light | Object detected |
| 2 | Green, continuous light | Operational readiness |

Part number code

Part designation: **AAA5d.EE/ ff-GG-hh-l**

| | |
|------|---|
| AAA5 | Operating principle / construction: HT5: diffuse reflection sensor with background suppression LS5: throughbeam photoelectric sensor transmitter LE5: throughbeam photoelectric sensor receiver ET5: energetic diffuse reflection sensor FT5: diffuse reflection sensor with fading PRK5: retro-reflective photoelectric sensor with polarization filter |
| d | Light type: n/a: red light l: infrared light |

Part no.: 50122576 – FT5.3/2N – Energetic diffuse sensor

| | |
|----|--|
| EE | Equipment: 1: adjustable range M: for semi-transparent objects H: for the detection of transparent films X: reinforced fading 3: teach-in via button R: combination product for reflector DTKS 30x50 |
| ff | Switching output / function / OUT1OUT2 (OUT1 = pin 4, OUT2 = pin 2): 2: NPN transistor output, light switching N: NPN transistor output, dark switching 4: PNP transistor output, light switching P: PNP transistor output, dark switching X: pin not used 9: deactivation input (deactivation with high signal) D: deactivation input (deactivation with low signal) |
| GG | Design: P1: narrow light beam |
| hh | Electrical connection: n/a: cable, standard length 2000 mm, 4-wire M8: M8 connector, 4-pin (plug) M8.3: M8 connector, 3-pin (plug) 200-M8: cable, length 200 mm with M8 connector, 4-pin, axial (plug) 200-M8.3: cable, length 200 mm with M8 connector, 3-pin, axial (plug) 200-M12: cable, length 200 mm with M12 connector, 4-pin, axial (plug) M8.1: Snap-in, M8 connector, 4-pin (plug) |
| I | Configuration: P1: different configuration |

Note

A list with all available device types can be found on the Leuze electronic website at www.leuze.com.

Notes
Observe intended use!

- This product is not a safety sensor and is not intended as personnel protection.
- The product may only be put into operation by competent persons.
- Only use the product in accordance with its intended use.

For UL applications:



- Only for use in "class 2" circuits
- These proximity switches shall be used with UL Listed Cable assemblies rated 30V, 0.5A min, in the field installation, or equivalent (categories: CYJV/CYJV7 or PVVA/PVVA7)

- Sum of the output currents for both outputs, 50 mA for ambient temperatures > 40 °C
- With the set scanning range, a tolerance of the operating range is possible depending on the reflection properties of the material surface.



Part no.: 50122576 – FT5.3/2N – Energetic diffuse sensor

Accessories

Mounting technology - Mounting brackets

| | Part no. | Designation | Article | Description |
|---|----------|---------------|---------------------|---|
|  | 50118542 | BT 200M.5 | Mounting bracket | Design of mounting device: Angle, L-shape Fastening, at system: Through-hole mounting Mounting bracket, at device: Screw type, Suited for M3 screws Type of mounting device: Adjustable Material: Stainless steel |
|  | 50124651 | BT 205M-10SET | Mounting device set | Contains: 10x Design of mounting device: Angle, L-shape Fastening, at system: Through-hole mounting Mounting bracket, at device: Screw type Type of mounting device: Rigid Material: Metal |

Mounting technology - Rod mounts

| | Part no. | Designation | Article | Description |
|---|----------|--------------|-----------------|---|
|  | 50117829 | BTP 200M-D12 | Mounting system | Design of mounting device: Protection hood Fastening, at system: For 12 mm rod Mounting bracket, at device: Screw type Type of mounting device: Clampable, Adjustable, Turning, 360° Material: Metal |
|  | 50117255 | BTU 200M-D12 | Mounting system | Contains: 2x M3 x 16 screw, 2 M3 x 20 screws, 2x position washers Design of mounting device: Mounting system Fastening, at system: For 12 mm rod, Sheet-metal mounting Mounting bracket, at device: Screw type, Suited for M3 screws Type of mounting device: Clampable, Adjustable, Turning, 360° Material: Metal |

Note

A list with all available accessories can be found on the Leuze electronic website in the Download tab of the article detailed page.