

M12 male 0° / M8 female 90° LED

PVC 3x0.25 bk UL/CSA 0,6m

Male straight to female 90°

M12 - M8, 3-pole

2 × LED (PNP), (NPN) on request

Plastic housings with good resistance against chemicals and oils. The resistance to aggressive media should be individually tested for your application. Further details on request. Further cable lengths on request.

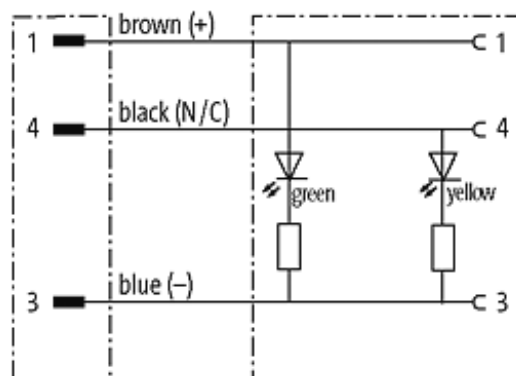
[Link to Product](#)**Illustration**

Male

Female

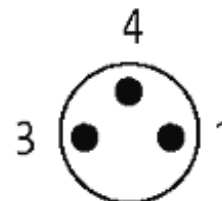
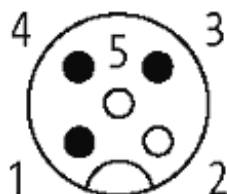

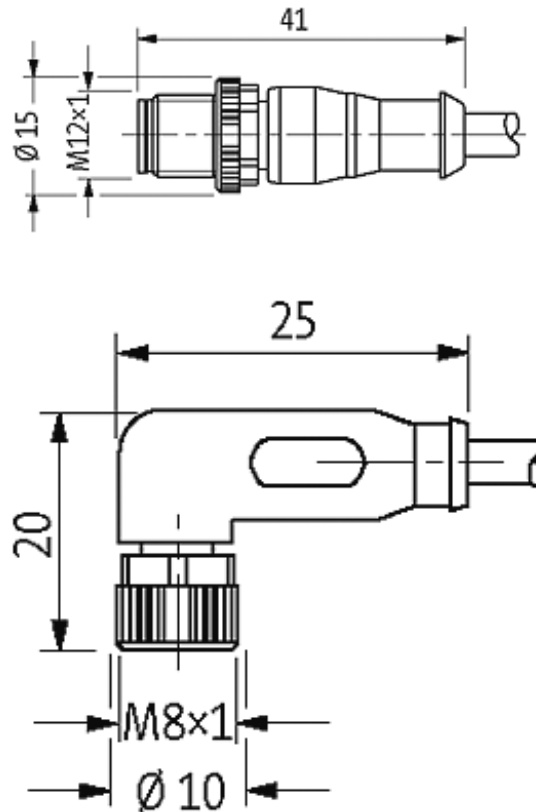

Product may differ from Image

Approvals



* only for products with UL/CSA approved cable

Form

40641

Technical Data

Operating voltage	24 V DC $\pm 25\%$
Operating current per contact	max. 4 A
Locking of ports	Screw thread M8/M12 \times 1 mm (recommended torque 0.4/0.6 Nm), self-securing
Protection	IP67 inserted and tightened (EN 60529)

Cables

Cable number	610
No./diameter of wires	3 \times 0.25 mm ²
Wire isolation	PVC (br, bl, bk)
Jacket Color	black
Shore hardness outer jacket	85 \pm 5A

Material (jacket)	PVC (UL/CSA)
Outer diameter	approx. 4.5 mm
Bend radius (fixed)	5 × outer Ø
Bend radius (moving)	10 × outer Ø
Temperature range (fixed)	-30...+80 °C
Temperature range (mobile)	-5...+80 °C

General data

Temperature range	-25...+85 °C, depending on cable quality
-------------------	--

Commercial data

country of origin	DE
customs tariff number	85444290
minimum order quantity	1