

**100V N-CHANNEL ENHANCEMENT MODE MOSFET IN SOT89 PACKAGE**

**Product Summary**

$V_{(BR)DSS}$	$R_{DS(on)}$ Max	$I_D$ max $T_A = 25^\circ C$ (Note 6)
100V	700m $\Omega$ @ $V_{GS} = 10V$	1.4A
	900m $\Omega$ @ $V_{GS} = 6V$	1.2A

**Description and Applications**

This MOSFET has been designed to minimize the on-state resistance ( $R_{DS(on)}$ ) and yet maintain superior switching performance, making it ideal for high efficiency power management applications.

- DC-DC Converters
- Power Management functions
- Motor control
- Disconnect switches

**Features and Benefits**

- Low On-Resistance
- Low Threshold
- Fast Switching Speed
- Low Gate Drive
- **Totally Lead-Free & Fully RoHS compliant (Notes 1 & 2)**
- **Halogen and Antimony Free. "Green" Device (Note 3)**
- **Qualified to AEC-Q101 Standards for High Reliability**

**Mechanical Data**

- Case: SOT89
- Case Material: Molded Plastic, "Green" Molding Compound. UL Flammability Classification Rating 94V-0
- Moisture Sensitivity: Level 1 per J-STD-020
- Terminals: Matte Tin Finish
- Weight: 0.052 grams (approximate)



Top View

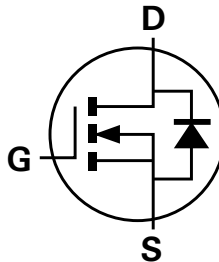

Device symbol

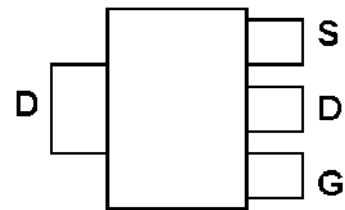

Top View  
Pin-Out

**Ordering Information** (Note 4)

Product	Marking	Reel size (inches)	Tape width (mm)	Quantity per reel
ZXMN10A07ZTA	7N10	7	12	1,000

- Notes:
1. No purposely added lead. Fully EU Directive 2002/95/EC (RoHS) & 2011/65/EU (RoHS 2) compliant.
  2. See <http://www.diodes.com> for more information about Diodes Incorporated's definitions of Halogen and Antimony free, "Green" and Lead-Free.
  3. Halogen and Antimony free "Green" products are defined as those which contain <900ppm bromine, <900ppm chlorine (<1500ppm total Br + Cl) and <1000ppm antimony compounds.
  4. For packaging details, go to our website at <http://www.diodes.com>

**Marking Information**

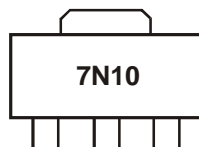

7N10 = Product type Marking Code

**Maximum Ratings** @T<sub>A</sub> = 25°C unless otherwise specified

Characteristic		Symbol	Value	Unit
Drain-Source Voltage		V <sub>DSS</sub>	100	V
Gate-Source Voltage		V <sub>GSS</sub>	±20	V
Continuous Drain Current	Steady State	@ V <sub>GS</sub> = 10V; T <sub>A</sub> = 25°C (Note 6)	1.4	A
		@ V <sub>GS</sub> = 10V; T <sub>A</sub> = 70°C (Note 6)	1.1	
		@ V <sub>GS</sub> = 10V; T <sub>A</sub> = 25°C (Note 5)	1.0	
Pulsed Drain Current (Note 7)		I <sub>DM</sub>	4.2	A
Continuous Source Current (Body Diode) (Note 6)		I <sub>S</sub>	2.1	A
Pulsed Source Current (Body Diode) (Note 7)		I <sub>SM</sub>	4.2	A

**Thermal Characteristics** @T<sub>A</sub> = 25°C unless otherwise specified

Characteristic		Symbol	Value	Unit
Power Dissipation (Note 5)		P <sub>D</sub>	1.5	W
Linear Derating Factor			12	mW/°C
Power Dissipation (Note 6)		P <sub>D</sub>	2.6	W
Linear Derating Factor			21	mW/°C
Thermal Resistance, Junction to Ambient (Note 5)		R <sub>θJA</sub>	83.3	°C/W
Thermal Resistance, Junction to Ambient (Note 6)		R <sub>θJA</sub>	47.4	°C/W
Thermal Resistance, Junction to Leads (Note 8)		R <sub>θJL</sub>	6.36	°C/W
Operating and Storage Temperature Range		T <sub>J</sub> , T <sub>STG</sub>	-55 to +150	°C

- Notes:
- For a device surface mounted on 25mm x 25mm FR4 PCB with high coverage of single sided 1oz copper, in still air conditions.
  - For a device surface mounted on FR4 PCB measured at t ≤ 10 sec.
  - Repetitive rating - 25mm x 25mm FR4 PCB, D = 0.02, pulse width 300µs – pulse width limited by maximum junction temperature.
  - Thermal resistance from junction to solder-point (at the end of the drain lead).

**Thermal Characteristics**

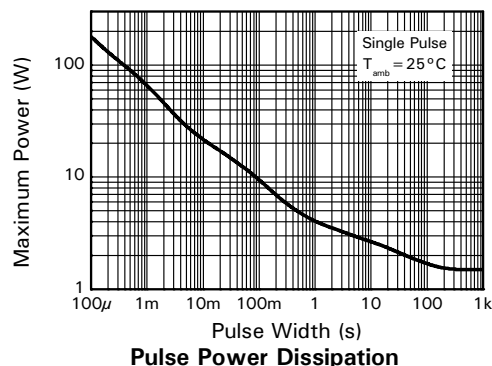
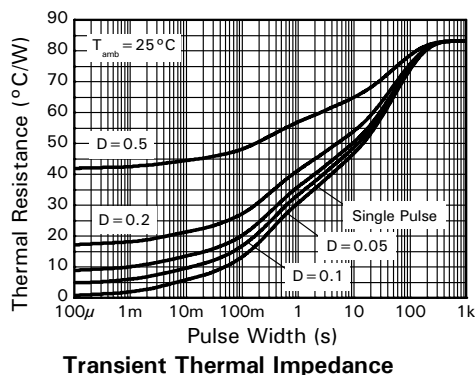
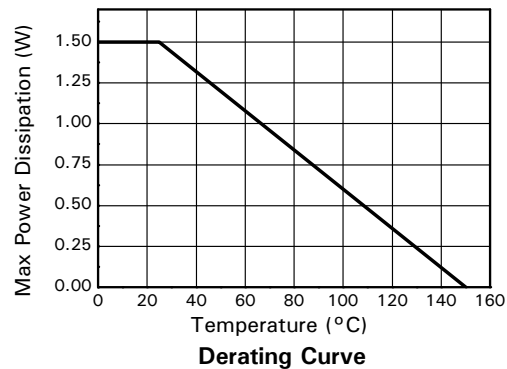
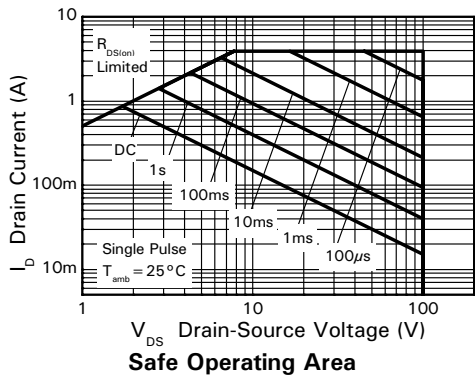

**Electrical Characteristics** @T<sub>A</sub> = 25°C unless otherwise specified

Characteristic	Symbol	Min	Typ	Max	Unit	Test Condition
<b>OFF CHARACTERISTICS</b>						
Drain-Source Breakdown Voltage	BV <sub>DSS</sub>	100	-	-	V	V <sub>GS</sub> = 0V, I <sub>D</sub> = 250μA
Zero Gate Voltage Drain Current T <sub>J</sub> = 25°C	I <sub>DSS</sub>	-	-	1.0	μA	V <sub>DS</sub> = 100V, V <sub>GS</sub> = 0V
Gate-Source Leakage	I <sub>GSS</sub>	-	-	100	nA	V <sub>GS</sub> = ±20V, V <sub>DS</sub> = 0V
<b>ON CHARACTERISTICS</b>						
Gate Threshold Voltage	V <sub>GS(th)</sub>	2	-	4	V	V <sub>DS</sub> = V <sub>GS</sub> , I <sub>D</sub> = 250μA
Static Drain-Source On-Resistance (Note 9)	R <sub>DS(on)</sub>	-	-	700	mΩ	V <sub>GS</sub> = 10V, I <sub>D</sub> = 1.5A
			-	900		V <sub>GS</sub> = 6V, I <sub>D</sub> = 1A
Forward Transconductance (Note 9 & 11)	g <sub>FS</sub>	-	1.6	-	S	V <sub>DS</sub> = 15V, I <sub>D</sub> = 1A
Diodes Forward Voltage (Note 9)	V <sub>SD</sub>	-	0.85	0.95	V	T <sub>J</sub> = 25°C, I <sub>S</sub> = 1.5A, V <sub>GS</sub> = 0V
<b>DYNAMIC CHARACTERISTICS</b>						
Input Capacitance (Note 10 & 11)	C <sub>iss</sub>	-	138	-	pF	V <sub>DS</sub> = 50V, V <sub>GS</sub> = 0V, f = 1.0MHz
Output Capacitance (Note 10 & 11)	C <sub>oss</sub>	-	12	-	pF	
Reverse Transfer Capacitance (Note 10 & 11)	C <sub>rss</sub>	-	6	-	pF	
Gate Resistance (Note 10 & 11)	R <sub>g</sub>	1.8	-	2.6	Ω	f = 1MHz, V <sub>GS</sub> = 0V, V <sub>DS</sub> = 0V
Total Gate Charge (Note 10 & 11)	Q <sub>g</sub>	-	2.9	-	nC	V <sub>GS</sub> = 10V, V <sub>DS</sub> = 50V, I <sub>D</sub> = 1A
Gate-Source Charge (Note 10 & 11)	Q <sub>gs</sub>	-	0.7	-	nC	
Gate-Drain Charge (Note 10 & 11)	Q <sub>gd</sub>	-	1	-	nC	
Reverse Recovery Time (Note 11)	t <sub>rr</sub>	-	27	-	ns	T <sub>J</sub> = 25°C, I <sub>F</sub> = 1A, di/dt = 100A/μs
Reverse Recovery Charge (Note 11)	Q <sub>rr</sub>	-	12	-	nC	
Turn-On Delay Time (Note 10 & 11)	t <sub>D(on)</sub>	-	1.8	-	ns	V <sub>GS</sub> = 10V, V <sub>DD</sub> = 50V, R <sub>G</sub> = 6Ω, I <sub>D</sub> = 1A
Turn-On Rise Time (Note 10 & 11)	t <sub>r</sub>	-	1.5	-	ns	
Turn-Off Delay Time (Note 10 & 11)	t <sub>D(off)</sub>	-	4.1	-	ns	
Turn-Off Fall Time (Note 10 & 11)	t <sub>f</sub>	-	2.1	-	ns	

- Notes:
- 9. Measured under pulsed conditions. Pulse width ≤ 300μs; duty cycle ≤ 2%.
  - 10. Switching characteristics are independent of operating junction temperature.
  - 11. For design aid only, not subject to production testing.

]

**Typical Characteristics**

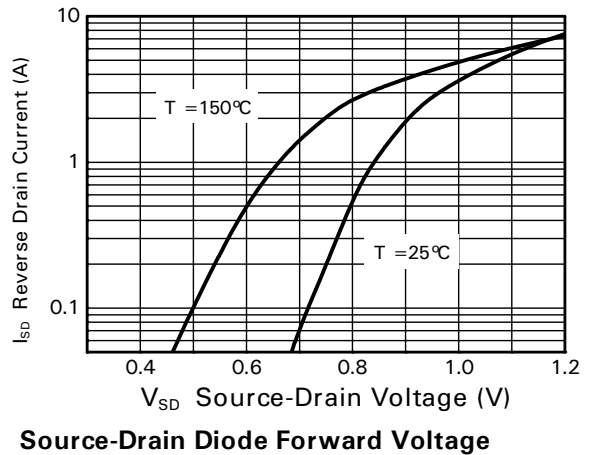
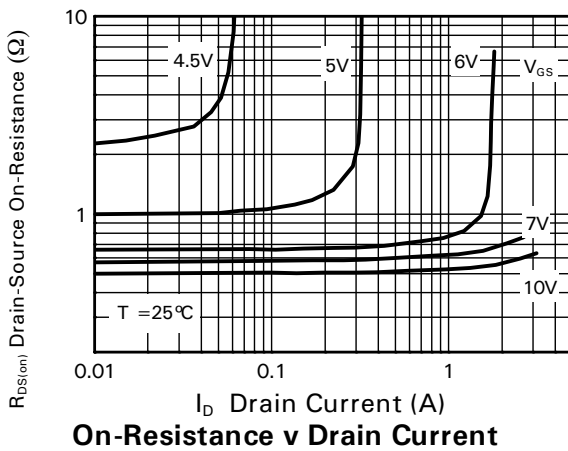
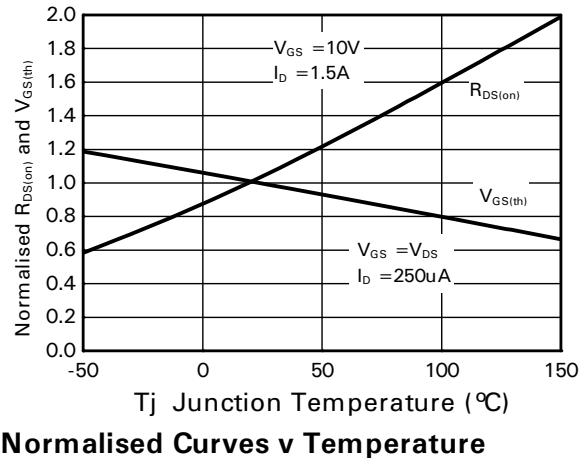
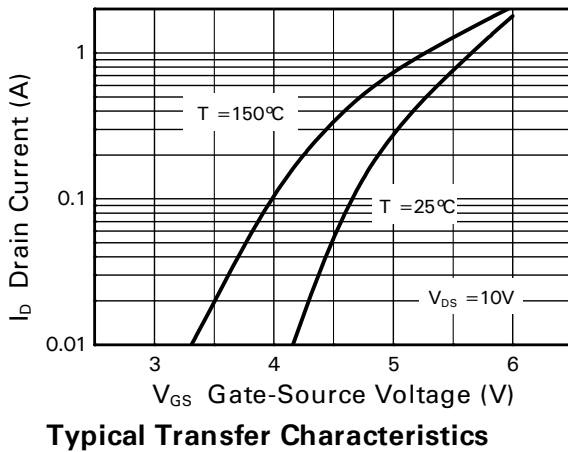
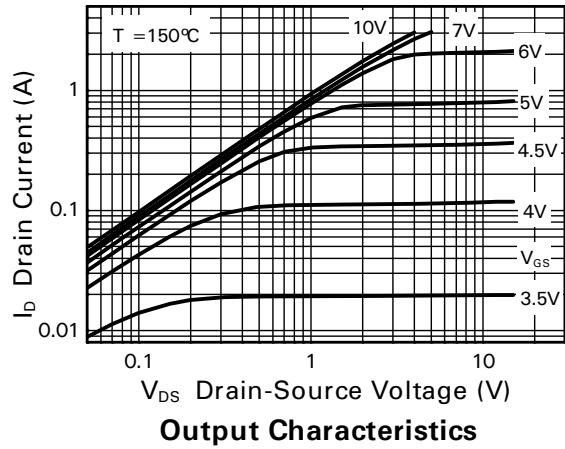
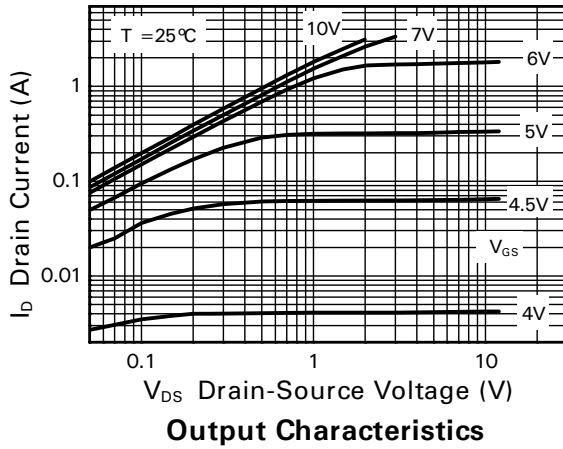

**Typical Characteristics - Continued**

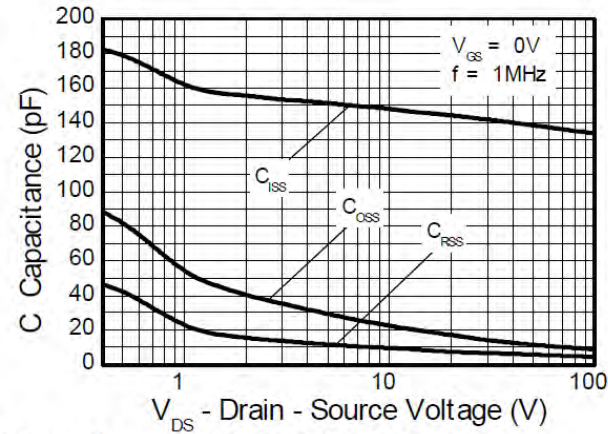

**Capacitance v Drain-Source Voltage**

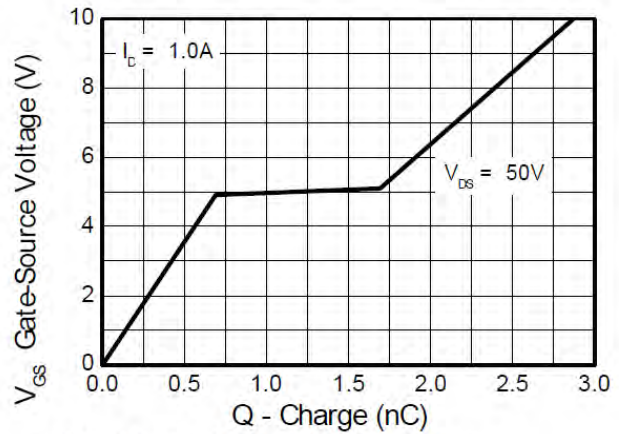

**Gate-Source Voltage v Gate Charge**

**Test Circuits**

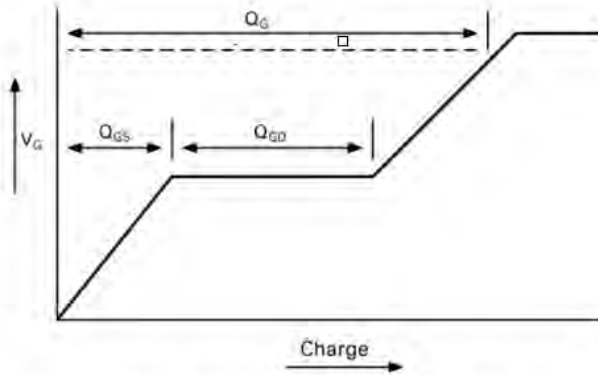

**Basic gate charge waveform**

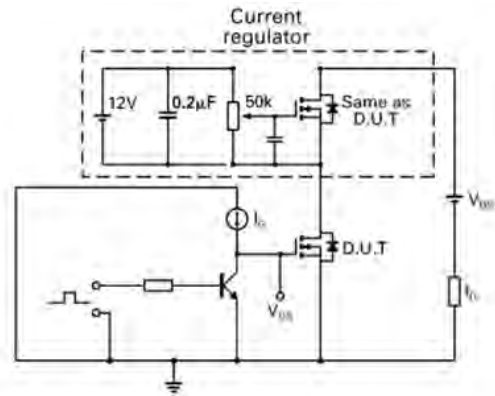

**Gate charge test circuit**

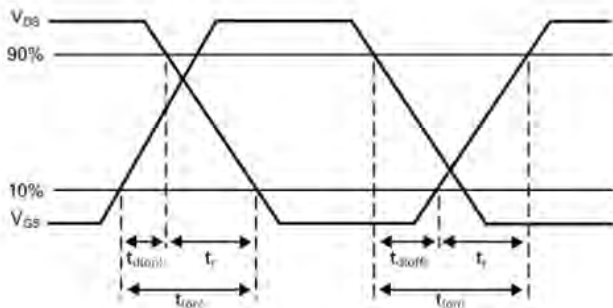

**Switching time waveforms**

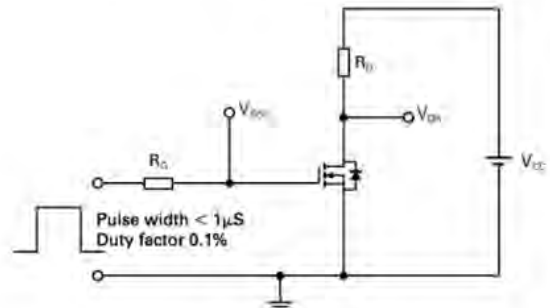

**Switching time test circuit**

**Package Outline Dimensions**

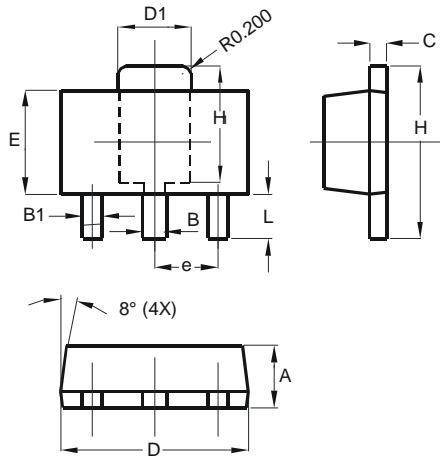

SOT89		
Dim	Min	Max
A	1.40	1.60
B	0.44	0.62
B1	0.35	0.54
C	0.35	0.44
D	4.40	4.60
D1	1.62	1.83
E	2.29	2.60
e	1.50 Typ	
H	3.94	4.25
H1	2.63	2.93
L	0.89	1.20
All Dimensions in mm		

**Suggested Pad Layout**

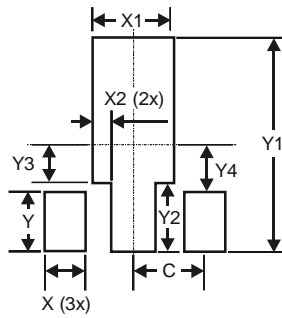

Dimensions	Value (in mm)
X	0.900
X1	1.733
X2	0.416
Y	1.300
Y1	4.600
Y2	1.475
Y3	0.950
Y4	1.125
C	1.500

#### IMPORTANT NOTICE

DIODES INCORPORATED MAKES NO WARRANTY OF ANY KIND, EXPRESS OR IMPLIED, WITH REGARDS TO THIS DOCUMENT, INCLUDING, BUT NOT LIMITED TO, THE IMPLIED WARRANTIES OF MERCHANTABILITY AND FITNESS FOR A PARTICULAR PURPOSE (AND THEIR EQUIVALENTS UNDER THE LAWS OF ANY JURISDICTION).

Diodes Incorporated and its subsidiaries reserve the right to make modifications, enhancements, improvements, corrections or other changes without further notice to this document and any product described herein. Diodes Incorporated does not assume any liability arising out of the application or use of this document or any product described herein; neither does Diodes Incorporated convey any license under its patent or trademark rights, nor the rights of others. Any Customer or user of this document or products described herein in such applications shall assume all risks of such use and will agree to hold Diodes Incorporated and all the companies whose products are represented on Diodes Incorporated website, harmless against all damages.

Diodes Incorporated does not warrant or accept any liability whatsoever in respect of any products purchased through unauthorized sales channel. Should Customers purchase or use Diodes Incorporated products for any unintended or unauthorized application, Customers shall indemnify and hold Diodes Incorporated and its representatives harmless against all claims, damages, expenses, and attorney fees arising out of, directly or indirectly, any claim of personal injury or death associated with such unintended or unauthorized application.

Products described herein may be covered by one or more United States, international or foreign patents pending. Product names and markings noted herein may also be covered by one or more United States, international or foreign trademarks.

#### LIFE SUPPORT

Diodes Incorporated products are specifically not authorized for use as critical components in life support devices or systems without the express written approval of the Chief Executive Officer of Diodes Incorporated. As used herein:

A. Life support devices or systems are devices or systems which:

1. are intended to implant into the body, or
2. support or sustain life and whose failure to perform when properly used in accordance with instructions for use provided in the labeling can be reasonably expected to result in significant injury to the user.

B. A critical component is any component in a life support device or system whose failure to perform can be reasonably expected to cause the failure of the life support device or to affect its safety or effectiveness.

Customers represent that they have all necessary expertise in the safety and regulatory ramifications of their life support devices or systems, and acknowledge and agree that they are solely responsible for all legal, regulatory and safety-related requirements concerning their products and any use of Diodes Incorporated products in such safety-critical, life support devices or systems, notwithstanding any devices- or systems-related information or support that may be provided by Diodes Incorporated. Further, Customers must fully indemnify Diodes Incorporated and its representatives against any damages arising out of the use of Diodes Incorporated products in such safety-critical, life support devices or systems.

Copyright © 2012, Diodes Incorporated

[www.diodes.com](http://www.diodes.com)