

EXTRUSION

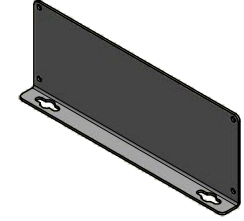

OPTIONAL FLANGED
END PANELS 1455UF

EXTRUSION DESIGNED FOR 186MM WIDE PC BOARD

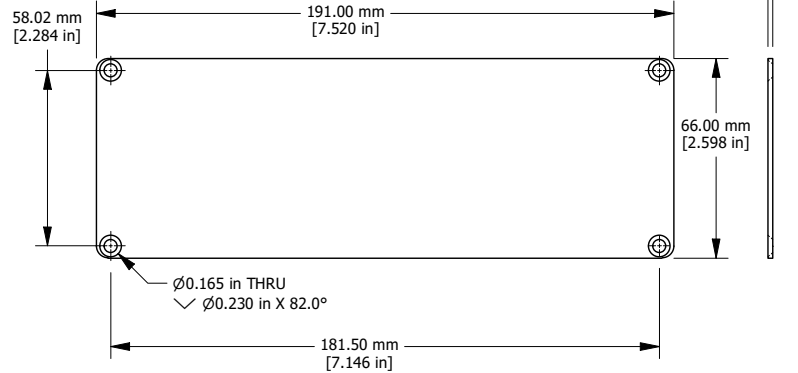
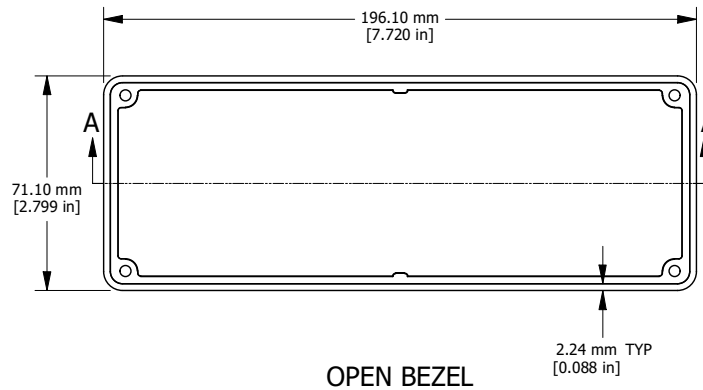
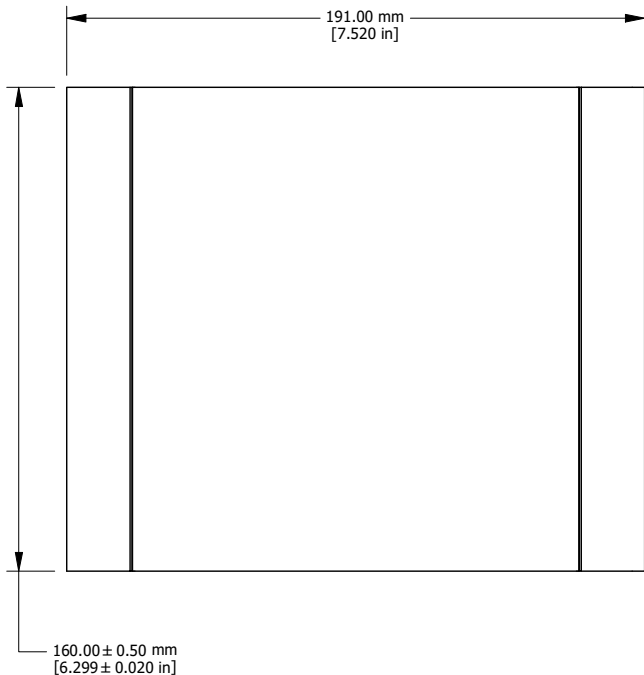

OPEN BEZEL

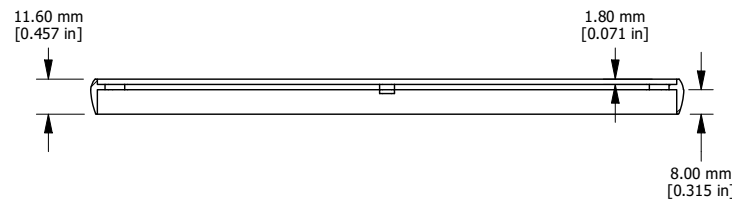

SECTION A-A

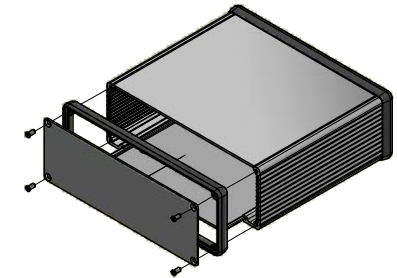

EXPLODED ISOMETRIC VIEW

Enclosures can be Factory Modified (Milling, Drilling, Printing etc.)
Solid models of this enclosure available in STEP or IGES.
Contact Factory mjm@hammondmfg.com

NOTE	
Purchased assembly includes box, plastic bezels, end panels, #6 Taptight screws and self adhesive rubber feet.	
Box made from Extruded Aluminum 6063.	
Bezels made with polycarbonate.	

1455U1601	
PART NUMBERS	
Clear Anodized	1455U1601
Black Anodized	1455U1601BK
ACCESSORIES	
See website for accessories.	



HAMMOND
MANUFACTURING™

1455U1601

www.hammondmfg.com