

E37930

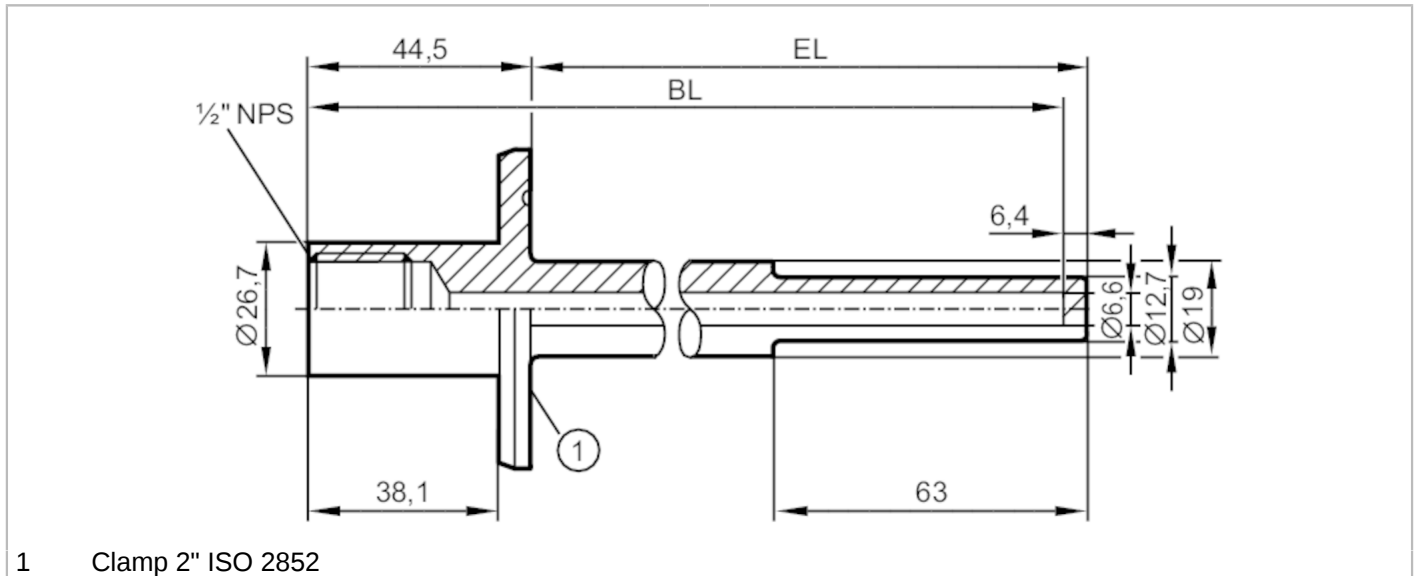

Thermowell for temperature sensors

THERMOWELL, D6/2" CLAMP/L=230



EC 1935/2004 EHEDG Certified FDA

Application	
Design	for temperature sensors EL = 300 mm
Pressure rating [bar]	25
Mechanical data	
Weight [g]	545
Materials	stainless steel (1.4404 / 316L)
Sensor connection	1/2 NPS Ø 6 mm suitable for G1/2 and 1/2" NPT
Process connection	Clamp DN50 (2") DIN 32676 (ISO 2852)
Surface characteristics Ra/Rz of the wetted parts	≤ 0.6 / -
Installation length EL [mm]	191
Bore length BL [mm]	228.6
Remarks	
Pack quantity	1 pcs.