

Contactor AC3: 55kW / 400 V 3-pole Size S6 Coil AC 50/60Hz and DC 96...127 V x (0,8...1,1) auxiliary contacts: 2 NO + 2 NC Main: Box terminal coil and auxilliary: screw and aux. circuit: screw terminal



Figure similar

Product brand name	SIRIUS
Product designation	Power contactor
Product type designation	3RT1
General technical data	
Size of contactor	S6
Product extension	
• function module for communication	No
• Auxiliary switch	Yes
Insulation voltage	
• rated value	1 000 V
Degree of pollution	3
Surge voltage resistance rated value	8 kV
maximum permissible voltage for safe isolation	
• between coil and main contacts acc. to EN 60947-1	690 V
Protection class IP	
• on the front	IP00

<ul style="list-style-type: none"> • of the terminal 	IP00
Shock resistance at rectangular impulse <ul style="list-style-type: none"> • at AC • at DC 	8,5g / 5 ms, 4,2g / 10 ms 8,5g / 5 ms, 4,2g / 10 ms
Shock resistance with sine pulse <ul style="list-style-type: none"> • at AC • at DC 	13,4g / 5 ms, 6,5g / 10 ms 13,4g / 5 ms, 6,5g / 10 ms
Mechanical service life (switching cycles) <ul style="list-style-type: none"> • of contactor typical • of the contactor with added electronics-compatible auxiliary switch block typical • of the contactor with added auxiliary switch block typical 	10 000 000 5 000 000 10 000 000

Ambient conditions

Installation altitude at height above sea level <ul style="list-style-type: none"> • maximum 	2 000 m
Ambient temperature <ul style="list-style-type: none"> • during operation • during storage 	-25 ... +60 °C -55 ... +80 °C

Main circuit

Number of poles for main current circuit	3
Number of NO contacts for main contacts	3
Operating voltage <ul style="list-style-type: none"> • at AC-3 rated value maximum 	1 000 V
Operating current <ul style="list-style-type: none"> • at AC-1 at 400 V <ul style="list-style-type: none"> — at ambient temperature 40 °C rated value • at AC-1 <ul style="list-style-type: none"> — up to 690 V at ambient temperature 40 °C rated value — up to 690 V at ambient temperature 60 °C rated value — up to 1000 V at ambient temperature 40 °C rated value — up to 1000 V at ambient temperature 60 °C rated value • at AC-2 at 400 V rated value • at AC-3 <ul style="list-style-type: none"> — at 400 V rated value — at 500 V rated value — at 690 V rated value — at 1000 V rated value 	160 A 160 A 140 A 80 A 80 A 115 A 115 A 115 A 53 A

Connectable conductor cross-section in main circuit at AC-1	
<ul style="list-style-type: none"> • at 60 °C minimum permissible • at 40 °C minimum permissible 	<p>50 mm²</p> <p>70 mm²</p>
Operating current for approx. 200000 operating cycles at AC-4	
<ul style="list-style-type: none"> • at 400 V rated value • at 690 V rated value 	<p>54 A</p> <p>48 A</p>
Operating current	
<ul style="list-style-type: none"> • at 1 current path at DC-1 <ul style="list-style-type: none"> — at 24 V rated value — at 110 V rated value — at 220 V rated value — at 440 V rated value — at 600 V rated value • with 2 current paths in series at DC-1 <ul style="list-style-type: none"> — at 24 V rated value — at 110 V rated value — at 220 V rated value — at 440 V rated value — at 600 V rated value • with 3 current paths in series at DC-1 <ul style="list-style-type: none"> — at 24 V rated value — at 110 V rated value — at 220 V rated value — at 440 V rated value — at 600 V rated value 	<p>160 A</p> <p>18 A</p> <p>3.4 A</p> <p>0.8 A</p> <p>0.5 A</p> <p>160 A</p> <p>160 A</p> <p>20 A</p> <p>3.2 A</p> <p>1.6 A</p> <p>160 A</p> <p>160 A</p> <p>160 A</p> <p>11.5 A</p> <p>4 A</p>
Operating current	
<ul style="list-style-type: none"> • at 1 current path at DC-3 at DC-5 <ul style="list-style-type: none"> — at 24 V rated value — at 110 V rated value — at 220 V rated value — at 440 V rated value — at 600 V rated value • with 2 current paths in series at DC-3 at DC-5 <ul style="list-style-type: none"> — at 24 V rated value — at 110 V rated value — at 220 V rated value — at 440 V rated value — at 600 V rated value • with 3 current paths in series at DC-3 at DC-5 <ul style="list-style-type: none"> — at 24 V rated value 	<p>160 A</p> <p>2.5 A</p> <p>0.6 A</p> <p>0.17 A</p> <p>0.12 A</p> <p>160 A</p> <p>160 A</p> <p>2.5 A</p> <p>0.65 A</p> <p>0.37 A</p> <p>160 A</p>

— at 110 V rated value	160 A
— at 220 V rated value	160 A
— at 440 V rated value	1.4 A
— at 600 V rated value	0.75 A
Operating power	
• at AC-1	
— at 230 V at 60 °C rated value	53 kW
— at 400 V rated value	92 kW
— at 400 V at 60 °C rated value	92 kW
— at 690 V rated value	160 kW
— at 690 V at 60 °C rated value	159 kW
— at 1000 V at 60 °C rated value	131 kW
• at AC-2 at 400 V rated value	55 kW
• at AC-3	
— at 230 V rated value	37 kW
— at 400 V rated value	55 kW
— at 500 V rated value	75 kW
— at 690 V rated value	110 kW
— at 1000 V rated value	75 kW
Operating power for approx. 200000 operating cycles at AC-4	
• at 400 V rated value	29 kW
• at 690 V rated value	48 kW
Thermal short-time current limited to 10 s	1 100 A
Power loss [W] at AC-3 at 400 V for rated value of the operating current per conductor	7 W
No-load switching frequency	
• at DC	1 000 1/h
Operating frequency	
• at AC-1 maximum	800 1/h
• at AC-2 maximum	400 1/h
• at AC-3 maximum	1 000 1/h
• at AC-4 maximum	130 1/h
Control circuit/ Control	
Type of voltage of the control supply voltage	AC/DC
Control supply voltage at AC	
• at 50 Hz rated value	96 ... 127 V
• at 60 Hz rated value	96 ... 127 V
Control supply voltage at DC	
• rated value	96 ... 127 V
Operating range factor control supply voltage rated value of magnet coil at DC	

<ul style="list-style-type: none"> • initial value 	0.8
<ul style="list-style-type: none"> • Full-scale value 	1.1
Operating range factor control supply voltage rated value of magnet coil at AC	
<ul style="list-style-type: none"> • at 50 Hz 	0.8 ... 1.1
<ul style="list-style-type: none"> • at 60 Hz 	0.8 ... 1.1
Design of the surge suppressor	with varistor
Apparent pick-up power of magnet coil at AC	
<ul style="list-style-type: none"> • at 50 Hz 	280 V·A
Inductive power factor with closing power of the coil	
<ul style="list-style-type: none"> • at 50 Hz 	0.8
Apparent holding power of magnet coil at AC	
<ul style="list-style-type: none"> • at 50 Hz 	4.4 V·A
Inductive power factor with the holding power of the coil	
<ul style="list-style-type: none"> • at 50 Hz 	0.5
Closing power of magnet coil at DC	320 W
Holding power of magnet coil at DC	2.8 W
Closing delay	
<ul style="list-style-type: none"> • at AC 	60 ... 75 ms
<ul style="list-style-type: none"> • at DC 	60 ... 75 ms
Opening delay	
<ul style="list-style-type: none"> • at AC 	115 ... 130 ms
<ul style="list-style-type: none"> • at DC 	115 ... 130 ms
Recovery time after power failure typical	2 s
Arcing time	10 ... 15 ms
Control version of the switch operating mechanism	Fail-safe PLC input (F-PLC-IN)

Auxiliary circuit

Number of NC contacts	
<ul style="list-style-type: none"> • for auxiliary contacts <ul style="list-style-type: none"> — instantaneous contact 	2
Number of NO contacts	
<ul style="list-style-type: none"> • for auxiliary contacts <ul style="list-style-type: none"> — instantaneous contact 	2
Operating current at AC-12 maximum	10 A
Operating current at AC-15	
<ul style="list-style-type: none"> • at 230 V rated value 	6 A
<ul style="list-style-type: none"> • at 400 V rated value 	3 A
<ul style="list-style-type: none"> • at 500 V rated value 	2 A
<ul style="list-style-type: none"> • at 690 V rated value 	1 A
Operating current at DC-12	
<ul style="list-style-type: none"> • at 24 V rated value 	10 A

<ul style="list-style-type: none"> • at 48 V rated value • at 60 V rated value • at 110 V rated value • at 125 V rated value • at 220 V rated value • at 600 V rated value 	<p>6 A</p> <p>6 A</p> <p>3 A</p> <p>2 A</p> <p>1 A</p> <p>0.15 A</p>
Operating current at DC-13	
<ul style="list-style-type: none"> • at 24 V rated value • at 48 V rated value • at 60 V rated value • at 110 V rated value • at 125 V rated value • at 220 V rated value • at 600 V rated value 	<p>10 A</p> <p>2 A</p> <p>2 A</p> <p>1 A</p> <p>0.9 A</p> <p>0.3 A</p> <p>0.1 A</p>
Contact reliability of auxiliary contacts	1 faulty switching per 100 million (17 V, 1 mA)

UL/CSA ratings

Full-load current (FLA) for three-phase AC motor	
<ul style="list-style-type: none"> • at 480 V rated value • at 600 V rated value 	<p>124 A</p> <p>125 A</p>
Yielded mechanical performance [hp]	
<ul style="list-style-type: none"> • for single-phase AC motor <ul style="list-style-type: none"> — at 230 V rated value • for three-phase AC motor <ul style="list-style-type: none"> — at 200/208 V rated value — at 220/230 V rated value — at 460/480 V rated value — at 575/600 V rated value 	<p>25 hp</p> <p>40 hp</p> <p>50 hp</p> <p>100 hp</p> <p>125 hp</p>
Contact rating of auxiliary contacts according to UL	A600 / P600

Short-circuit protection

Design of the fuse link	
<ul style="list-style-type: none"> • for short-circuit protection of the main circuit <ul style="list-style-type: none"> — with type of coordination 1 required — with type of assignment 2 required • for short-circuit protection of the auxiliary switch required 	<p>Fuse gG: 355 A</p> <p>Fuse gG: 315 A</p> <p>fuse gG: 10 A</p>

Installation/ mounting/ dimensions

Mounting position	+/-180° rotation possible on vertical mounting surface; can be tilted forward and backward by +/- 22.5° on vertical mounting surface
Mounting type	screw fixing
<ul style="list-style-type: none"> • Side-by-side mounting 	Yes

Height	172 mm
Width	120 mm
Depth	170 mm





Connections/Terminals

Type of electrical connection	
<ul style="list-style-type: none"> • for main current circuit • for auxiliary and control current circuit 	<p>screw-type terminals</p> <p>screw-type terminals</p>
Type of connectable conductor cross-sections	
<ul style="list-style-type: none"> • for main contacts <ul style="list-style-type: none"> — stranded — finely stranded with core end processing — finely stranded without core end processing • at AWG conductors for main contacts 	<p>max. 2x 70 mm²</p> <p>max. 1x 50, 1x 70 mm²</p> <p>max. 1x 50, 1x 70 mm²</p> <p>2x 1/0</p>
Type of connectable conductor cross-sections	
<ul style="list-style-type: none"> • for auxiliary contacts <ul style="list-style-type: none"> — solid — single or multi-stranded — finely stranded with core end processing • at AWG conductors for auxiliary contacts 	<p>2x (0.5 ... 1.5 mm²), 2x (0.75 ... 2.5 mm²), max. 2x (0.75 ... 4 mm²)</p> <p>2x (0,5 ... 1,5 mm²), 2x (0,75 ... 2,5 mm²), max. 2x (0,75 ... 4 mm²)</p> <p>2x (0.5 ... 1.5 mm²), 2x (0.75 ... 2.5 mm²)</p> <p>2x (20 ... 16), 2x (18 ... 14), 1x 12</p>

Safety related data

Safety device type acc. to IEC 61508-2	Type B
B10 value	
<ul style="list-style-type: none"> • with high demand rate acc. to SN 31920 	1 000 000
Safety Integrity Level (SIL) acc. to IEC 61508	2
SIL Claim Limit (subsystem) acc. to EN 62061	2
Performance level (PL) acc. to EN ISO 13849-1	c
Category acc. to EN ISO 13849-1	2
Stop category acc. to DIN EN 60204-1	0
Proportion of dangerous failures	
<ul style="list-style-type: none"> • with low demand rate acc. to SN 31920 • with high demand rate acc. to SN 31920 	<p>40 %</p> <p>73 %</p>
Product function	
<ul style="list-style-type: none"> • Mirror contact acc. to IEC 60947-4-1 • positively driven operation acc. to IEC 60947-5-1 	<p>Yes</p> <p>No</p>
PFHD with high demand rate acc. to EN 62061	0.00000045 1/h
PFDavg with low demand rate acc. to IEC 61508	0.007
MTBF	75 y
Hardware fault tolerance acc. to IEC 61508	0
T1 value for proof test interval or service life acc. to IEC 61508	20 y

Certificates/approvals

General Product Approval	Functional Safety/Safety of Machinery	Declaration of Conformity	Test Certificates
 CCC	 CSA		 EG-Konf.
		Type Examination Certificate	Special Test Certificate

Marine / Shipping	other
 DNV-GL DNVGL.COM/AF	Confirmation
	Miscellaneous

Further information

Information- and Downloadcenter (Catalogs, Brochures,...)

<http://www.siemens.com/industrial-controls/catalogs>

Industry Mall (Online ordering system)

<https://mall.industry.siemens.com/mall/en/en/Catalog/product?mlfb=3RT1054-1SF36>

Cax online generator

<http://support.automation.siemens.com/WW/CAXorder/default.aspx?lang=en&mlfb=3RT1054-1SF36>

Service&Support (Manuals, Certificates, Characteristics, FAQs,...)

<https://support.industry.siemens.com/cs/ww/en/ps/3RT1054-1SF36>

Image database (product images, 2D dimension drawings, 3D models, device circuit diagrams, EPLAN macros, ...)

http://www.automation.siemens.com/bilddb/cax_de.aspx?mlfb=3RT1054-1SF36&lang=en

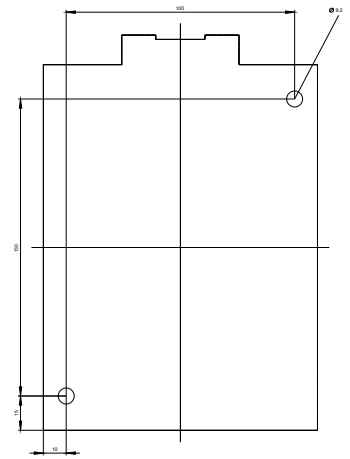
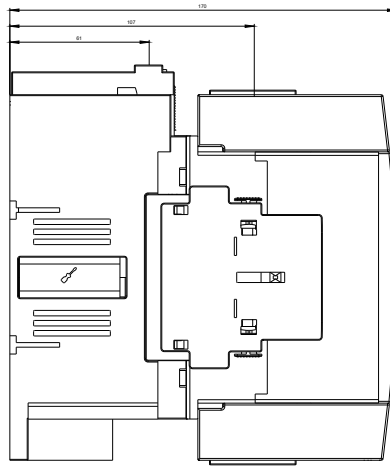
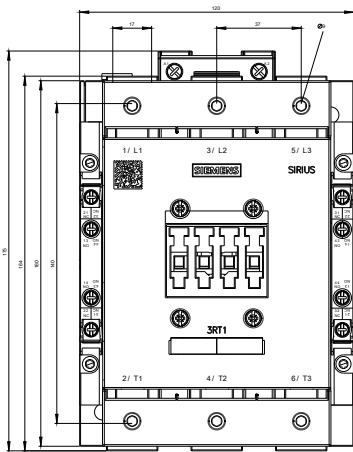

last modified:

10/13/2017