



**MICROCHIP**

---

**EVB-LAN9370  
Evaluation Board  
User's Guide**

---

---

**Note the following details of the code protection feature on Microchip devices:**

- Microchip products meet the specifications contained in their particular Microchip Data Sheet.
- Microchip believes that its family of products is secure when used in the intended manner and under normal conditions.
- There are dishonest and possibly illegal methods being used in attempts to breach the code protection features of the Microchip devices. We believe that these methods require using the Microchip products in a manner outside the operating specifications contained in Microchip's Data Sheets. Attempts to breach these code protection features, most likely, cannot be accomplished without violating Microchip's intellectual property rights.
- Microchip is willing to work with any customer who is concerned about the integrity of its code.
- Neither Microchip nor any other semiconductor manufacturer can guarantee the security of its code. Code protection does not mean that we are guaranteeing the product is "unbreakable." Code protection is constantly evolving. We at Microchip are committed to continuously improving the code protection features of our products. Attempts to break Microchip's code protection feature may be a violation of the Digital Millennium Copyright Act. If such acts allow unauthorized access to your software or other copyrighted work, you may have a right to sue for relief under that Act.

---

Information contained in this publication is provided for the sole purpose of designing with and using Microchip products. Information regarding device applications and the like is provided only for your convenience and may be superseded by updates. It is your responsibility to ensure that your application meets with your specifications.

THIS INFORMATION IS PROVIDED BY MICROCHIP "AS IS". MICROCHIP MAKES NO REPRESENTATIONS OR WARRANTIES OF ANY KIND WHETHER EXPRESS OR IMPLIED, WRITTEN OR ORAL, STATUTORY OR OTHERWISE, RELATED TO THE INFORMATION INCLUDING BUT NOT LIMITED TO ANY IMPLIED WARRANTIES OF NON-INFRINGEMENT, MERCHANTABILITY, AND FITNESS FOR A PARTICULAR PURPOSE OR WARRANTIES RELATED TO ITS CONDITION, QUALITY, OR PERFORMANCE.

IN NO EVENT WILL MICROCHIP BE LIABLE FOR ANY INDIRECT, SPECIAL, PUNITIVE, INCIDENTAL OR CONSEQUENTIAL LOSS, DAMAGE, COST OR EXPENSE OF ANY KIND WHATSOEVER RELATED TO THE INFORMATION OR ITS USE, HOWEVER CAUSED, EVEN IF MICROCHIP HAS BEEN ADVISED OF THE POSSIBILITY OR THE DAMAGES ARE FORESEEABLE. TO THE FULLEST EXTENT ALLOWED BY LAW, MICROCHIP'S TOTAL LIABILITY ON ALL CLAIMS IN ANY WAY RELATED TO THE INFORMATION OR ITS USE WILL NOT EXCEED THE AMOUNT OF FEES, IF ANY, THAT YOU HAVE PAID DIRECTLY TO MICROCHIP FOR THE INFORMATION. Use of Microchip devices in life support and/or safety applications is entirely at the buyer's risk, and the buyer agrees to defend, indemnify and hold harmless Microchip from any and all damages, claims, suits, or expenses resulting from such use. No licenses are conveyed, implicitly or otherwise, under any Microchip intellectual property rights unless otherwise stated.

#### **Trademarks**

The Microchip name and logo, the Microchip logo, Adaptec, AnyRate, AVR, AVR logo, AVR Freaks, BesTime, BitCloud, chipKIT, chipKIT logo, CryptoMemory, CryptoRF, dsPIC, FlashFlex, flexPWR, HELDO, IGLOO, JukeBlox, KeeLoq, Kleer, LANCheck, LinkMD, maXStylus, maXTouch, MediaLB, megaAVR, Microsemi, Microsemi logo, MOST, MOST logo, MPLAB, OptoLyzer, PackeTime, PIC, picoPower, PICSTART, PIC32 logo, PolarFire, Prochip Designer, QTouch, SAM-BA, SenGenuity, SpyNIC, SST, SST Logo, SuperFlash, Symmetricom, SyncServer, Tachyon, TimeSource, tinyAVR, UNI/O, Vectron, and XMEGA are registered trademarks of Microchip Technology Incorporated in the U.S.A. and other countries.

AgileSwitch, APT, ClockWorks, The Embedded Control Solutions Company, EtherSynch, FlashTec, Hyper Speed Control, HyperLight Load, IntelliMOS, Libero, motorBench, mTouch, Powermite 3, Precision Edge, ProASIC, ProASIC Plus, ProASIC Plus logo, Quiet-Wire, SmartFusion, SyncWorld, Temux, TimeCesium, TimeHub, TimePictra, TimeProvider, WinPath, and ZL are registered trademarks of Microchip Technology Incorporated in the U.S.A.

Adjacent Key Suppression, AKS, Analog-for-the-Digital Age, Any Capacitor, AnyIn, AnyOut, Augmented Switching, BlueSky, BodyCom, CodeGuard, CryptoAuthentication, CryptoAutomotive, CryptoCompanion, CryptoController, dsPICDEM, dsPICDEM.net, Dynamic Average Matching, DAM, ECAN, Espresso T1S, EtherGREEN, IdealBridge, In-Circuit Serial Programming, ICSP, INICnet, Intelligent Paralleling, Inter-Chip Connectivity, JitterBlocker, maxCrypto, maxView, memBrain, Mindi, MiWi, MPASM, MPF, MPLAB Certified logo, MPLIB, MPLINK, MultiTRAK, NetDetach, Omniscient Code Generation, PICDEM, PICDEM.net, PICKit, PICtail, PowerSmart, PureSilicon, QMatrix, REAL ICE, Ripple Blocker, RTAX, RTG4, SAM-ICE, Serial Quad I/O, simpleMAP, SimpliPHY, SmartBuffer, SMART-I.S., storClad, SQL, SuperSwitcher, SuperSwitcher II, Switchtec, SynchroPHY, Total Endurance, TSHARC, USBCheck, VariSense, VectorBlox, VeriPHY, ViewSpan, WiperLock, XpressConnect, and ZENA are trademarks of Microchip Technology Incorporated in the U.S.A. and other countries.

SQTP is a service mark of Microchip Technology Incorporated in the U.S.A.

The Adaptec logo, Frequency on Demand, Silicon Storage Technology, and Symmcom are registered trademarks of Microchip Technology Inc. in other countries.

GestlC is a registered trademark of Microchip Technology Germany II GmbH & Co. KG, a subsidiary of Microchip Technology Inc., in other countries.

All other trademarks mentioned herein are property of their respective companies.

© 2021, Microchip Technology Incorporated, All Rights Reserved.

ISBN: 978-1-5224-7643-6

For information regarding Microchip's Quality Management Systems, please visit [www.microchip.com/quality](http://www.microchip.com/quality).

---



---

## Table of Contents

---



---

<b>Preface .....</b>	<b>5</b>
<b>Chapter 1. Overview</b>	
1.1 Introduction .....	9
1.2 Block Diagram .....	9
<b>Chapter 2. Getting Started</b>	
2.1 Introduction .....	11
2.2 Setting Up the Hardware .....	11
2.3 Setting Up the Serial Port .....	13
2.4 Port Numbering .....	14
2.5 Useful Commands .....	15
<b>Chapter 3. Hardware Configuration</b>	
3.1 Introduction .....	17
3.1.1 LED Indicators .....	18
3.1.2 Jumpers .....	18
3.1.3 Headers/Test Points .....	18
3.1.4 Connector Descriptions .....	19
<b>Appendix A. Schematics</b>	
A.1 Introduction .....	21
<b>Appendix B. Bill of Materials</b>	
B.1 Introduction .....	25
<b>Worldwide Sales and Service .....</b>	<b>30</b>

# EVB-LAN9370 Evaluation Board User's Guide

---

---

NOTES:



---

---

## Preface

---

---

### NOTICE TO CUSTOMERS

All documentation becomes dated, and this manual is no exception. Microchip tools and documentation are constantly evolving to meet customer needs, so some actual dialogs and/or tool descriptions may differ from those in this document. Please refer to our web site ([www.microchip.com](http://www.microchip.com)) to obtain the latest documentation available.

Documents are identified with a “DS” number. This number is located on the bottom of each page, in front of the page number. The numbering convention for the DS number is “DSXXXXXA”, where “XXXXX” is the document number and “A” is the revision level of the document.

For the most up-to-date information on development tools, see the MPLAB® IDE online help. Select the Help menu, and then Topics to open a list of available online help files.

## INTRODUCTION

This chapter contains general information that will be useful to know before using the Microchip EVB-LAN9370 Evaluation Board. Items discussed in this chapter include:

- [Document Layout](#)
- [Conventions Used in this Guide](#)
- [Warranty Registration](#)
- [The Microchip Website](#)
- [Development Systems Customer Change Notification Service](#)
- [Customer Support](#)
- [Document Revision History](#)

## DOCUMENT LAYOUT

This document features the EVB-LAN9370 Evaluation Board. The manual layout is as follows:

- **Chapter 1. “Overview”** – This chapter provides a brief description of the EVB-LAN9370.
- **Chapter 2. “Getting Started”** – This chapter provides information on the setup of the SAM E70.
- **Chapter 3. “Hardware Configuration”** – This chapter includes information on the hardware configuration of the EVB-LAN9370.
- **Appendix A. “Schematics”** – This appendix shows the EVB-LAN9370 schematic diagrams.
- **Appendix B. “Bill of Materials”** – This appendix includes the EVB-LAN9370 Bill of Materials.

# EVB-LAN9370 Evaluation Board User's Guide

## CONVENTIONS USED IN THIS GUIDE

This manual uses the following documentation conventions:

### DOCUMENTATION CONVENTIONS

Description	Represents	Examples
<b>Arial font:</b>		
Italic characters	Referenced books	<i>MPLAB<sup>®</sup> IDE User's Guide</i>
	Emphasized text	...is the <i>only</i> compiler...
Initial caps	A window	the Output window
	A dialog	the Settings dialog
	A menu selection	select Enable Programmer
Quotes	A field name in a window or dialog	"Save project before build"
Underlined, italic text with right angle bracket	A menu path	<u><i>File&gt;Save</i></u>
Bold characters	A dialog button	Click <b>OK</b>
	A tab	Click the <b>Power</b> tab
N'Rnnnn	A number in verilog format, where N is the total number of digits, R is the radix and n is a digit.	4'b0010, 2'hF1
Text in angle brackets < >	A key on the keyboard	Press <Enter>, <F1>
<b>Courier New font:</b>		
Plain Courier New	Sample source code	<code>#define START</code>
	Filenames	<code>autoexec.bat</code>
	File paths	<code>c:\mcc18\h</code>
	Keywords	<code>_asm, _endasm, static</code>
	Command-line options	<code>-Opa+, -Opa-</code>
	Bit values	<code>0, 1</code>
	Constants	<code>0x1F, 'A'</code>
Italic Courier New	A variable argument	<i>file.o</i> , where <i>file</i> can be any valid filename
Square brackets [ ]	Optional arguments	<code>mcc18 [options] file [options]</code>
Curly brackets and pipe character: {   }	Choice of mutually exclusive arguments; an OR selection	<code>errorlevel {0 1}</code>
Ellipses...	Replaces repeated text	<code>var_name [, var_name...]</code>
	Represents code supplied by user	<code>void main (void) { ... }</code>

## WARRANTY REGISTRATION

Please complete the enclosed Warranty Registration Card and mail it promptly. Sending the Warranty Registration Card entitles users to receive new product updates. Interim software releases are available at the Microchip website.

## THE MICROCHIP WEBSITE

Microchip provides online support via our website at [www.microchip.com](http://www.microchip.com). This website is used as a means to make files and information easily available to customers. Accessible by using your favorite Internet browser, the website contains the following information:

- **Product Support** – Data sheets and errata, application notes and sample programs, design resources, user's guides and hardware support documents, latest software releases and archived software
- **General Technical Support** – Frequently Asked Questions (FAQs), technical support requests, online discussion groups, Microchip consultant program member listing
- **Business of Microchip** – Product selector and ordering guides, latest Microchip press releases, listing of seminars and events, listings of Microchip sales offices, distributors and factory representatives

## DEVELOPMENT SYSTEMS CUSTOMER CHANGE NOTIFICATION SERVICE

Microchip's customer notification service helps keep customers current on Microchip products. Subscribers will receive e-mail notification whenever there are changes, updates, revisions, or errata related to a specified product family or development tool of interest.

To register, access the Microchip web site at [www.microchip.com](http://www.microchip.com), click on Customer Change Notification and follow the registration instructions.

The Development Systems product group categories are:

- **Compilers** – The latest information on Microchip C compilers, assemblers, linkers and other language tools. These include all MPLABCC compilers; all MPLAB assemblers (including MPASM™ assembler); all MPLAB linkers (including MPLINK™ object linker); and all MPLAB librarians (including MPLIB™ object librarian).
- **Emulators** – The latest information on Microchip in-circuit emulators. This includes the MPLAB® REAL ICE™ and MPLAB ICE 2000 in-circuit emulators.
- **In-Circuit Debuggers** – The latest information on the Microchip in-circuit debuggers. This includes MPLAB ICD 3 in-circuit debuggers and PICKit™ 3 debug express.
- **MPLAB IDE** – The latest information on Microchip MPLAB IDE, the Windows® Integrated Development Environment for development systems tools. This list is focused on the MPLAB IDE, MPLAB IDE Project Manager, MPLAB Editor and MPLAB SIM simulator, as well as general editing and debugging features.
- **Programmers** – The latest information on Microchip programmers. These include production programmers such as MPLAB REAL ICE in-circuit emulator, MPLAB ICD 3 in-circuit debugger and MPLAB PM3 device programmers. Also included are non-production development programmers such as PICSTART® Plus and PICKit™ 2 and 3.



# EVB-LAN9370 Evaluation Board User's Guide

---

## CUSTOMER SUPPORT

Users of Microchip products can receive assistance through several channels:

- Distributor or Representative
- Local Sales Office
- Field Application Engineer (FAE)
- Technical Support

Customers should contact their distributor, representative or field application engineer (FAE) for support. Local sales offices are also available to help customers. A listing of sales offices and locations is included in the back of this document.

Technical support is available through the web site at:

<http://www.microchip.com/support>

## DOCUMENT REVISION HISTORY

Revisions	Section/Figure/Entry	Correction
DS50003123A (02-10-21)	Initial release	

## Chapter 1. Overview

### 1.1 INTRODUCTION

This EVB-LAN9370 evaluation board is a daughter board that interfaces to either:

- The SAM E70 Xplained Ultra Evaluation Kit (Part Number: DM320113) running FreeRTOS
- The SAMA5D3-Ethernet Development System board (Part Number: DM320114) running Linux®

The board contains four IEEE100BASE-T1 ports with two-wire, screw-down terminal blocks. The board-to-board interface is RMII, SPI, and MIIM; and uses dual SIP connectors (24 pins in total).

The board receives 3.3V from the SAM board and generates 1.1V for the low voltages.

### 1.2 BLOCK DIAGRAM

**FIGURE 1-1: EVB-LAN9370 BLOCK DIAGRAM**

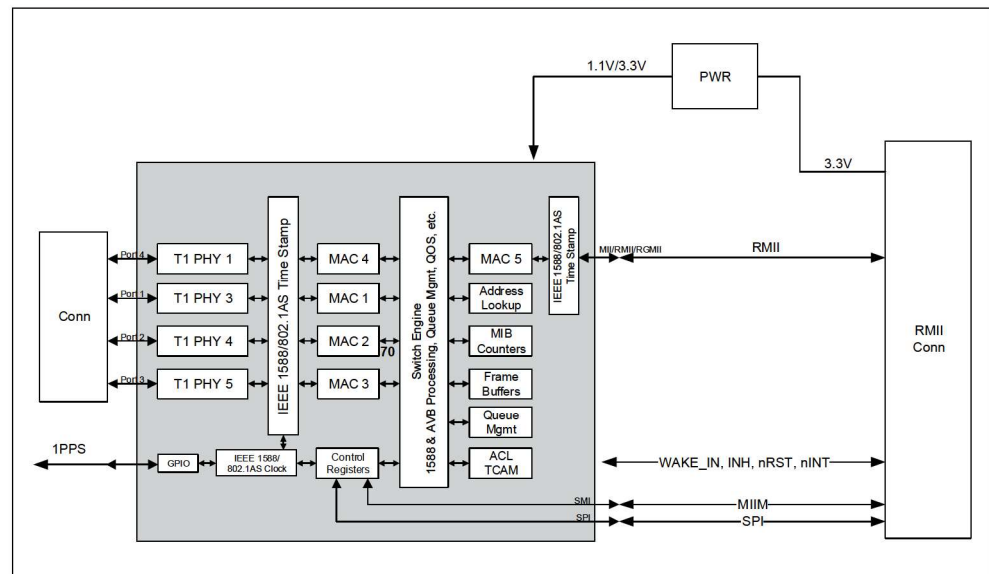



# EVB-LAN9370 Evaluation Board User's Guide

---

---

NOTES:

---

---

## Chapter 2. Getting Started

---

---

### 2.1 INTRODUCTION

This section describes the steps to configure the SAM E70.

**Note:** SAM E70 Xplained Ultra board order number DM320113 is required.

### 2.2 SETTING UP THE HARDWARE

1. Remove the Ethernet PHY daughter board from the SAM E70 board.
2. Remove jumper J805 on the SAM E70 boards. The jumper is located under the daughter board.
3. Remove the video card interface (see [Figure 2-1](#)).
4. Connect the EVB-LAN9370 onto the “Ethernet PHY module” connector on the SAM E70 Xplained Ultra board as shown in [Figure 2-1](#).
5. Connect the 100BASE-T1 cables on the EVB.

**Note:** Take note of the polarity (auto-polarity is disabled by default).

6. Connect a USB cable between a PC and the Debug USB connector on the SAM E70 board.

# EVB-LAN9370 Evaluation Board User's Guide

FIGURE 2-1: EVB-LAN9370 CONNECTION TO SAM E70

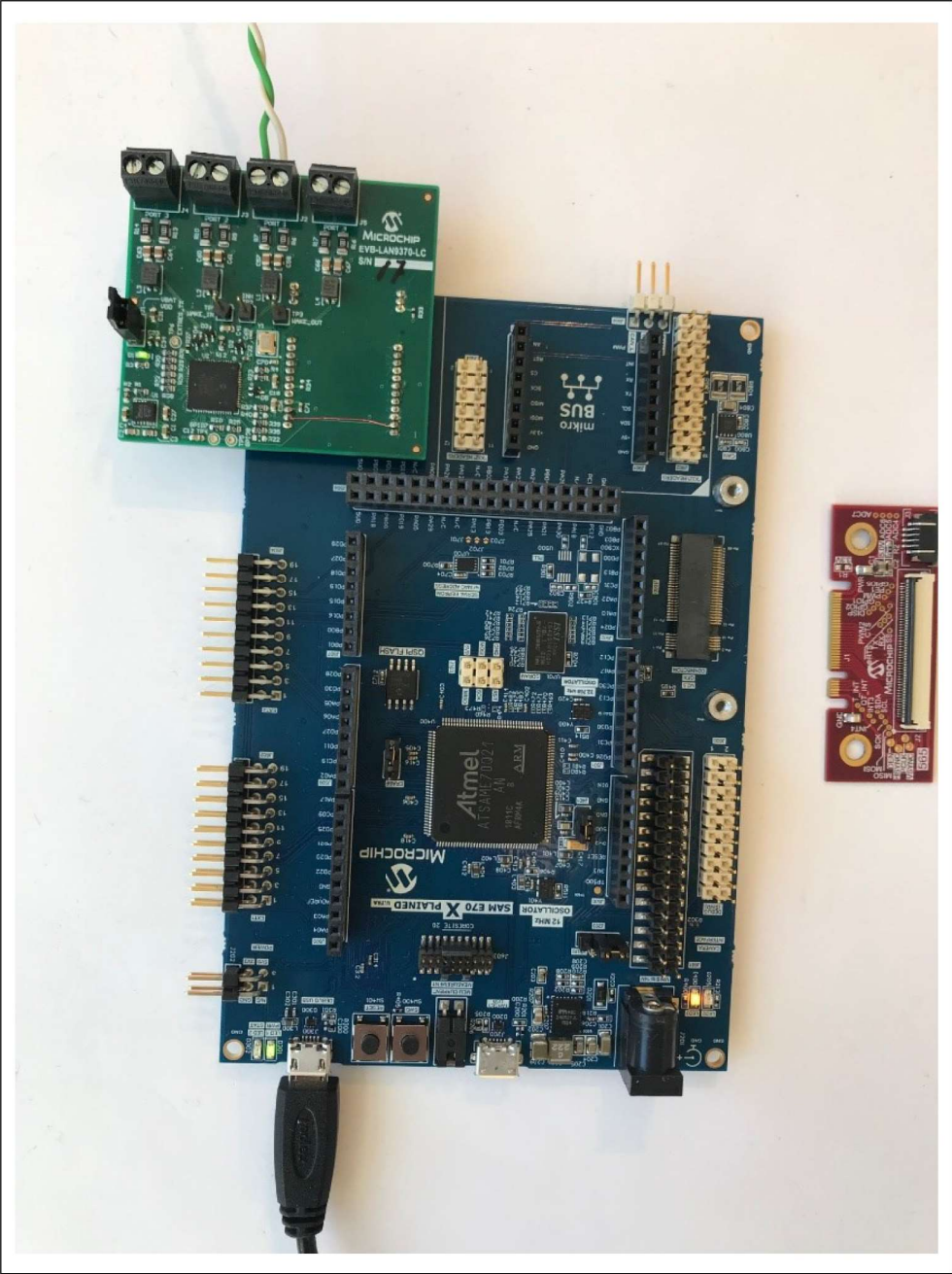

## 2.3 SETTING UP THE SERIAL PORT

1. On the PC, start the terminal program (TeraTerm).
2. Connect to the EDBG Virtual COM port as shown in [Figure 2-2](#).

**FIGURE 2-2: TERATERM - NEW CONNECTION**

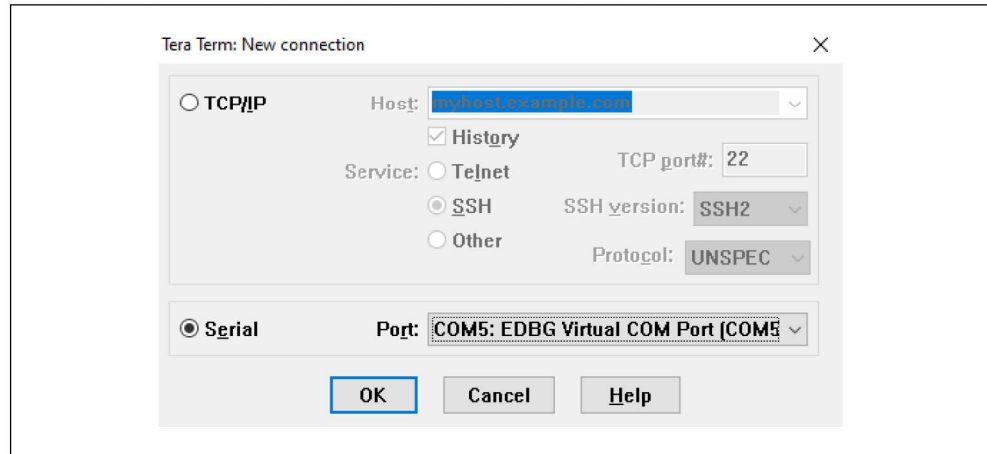

3. Configure the serial parameters.

**FIGURE 2-3: TERATERM - SERIAL PORT SETUP AND CONNECTION**

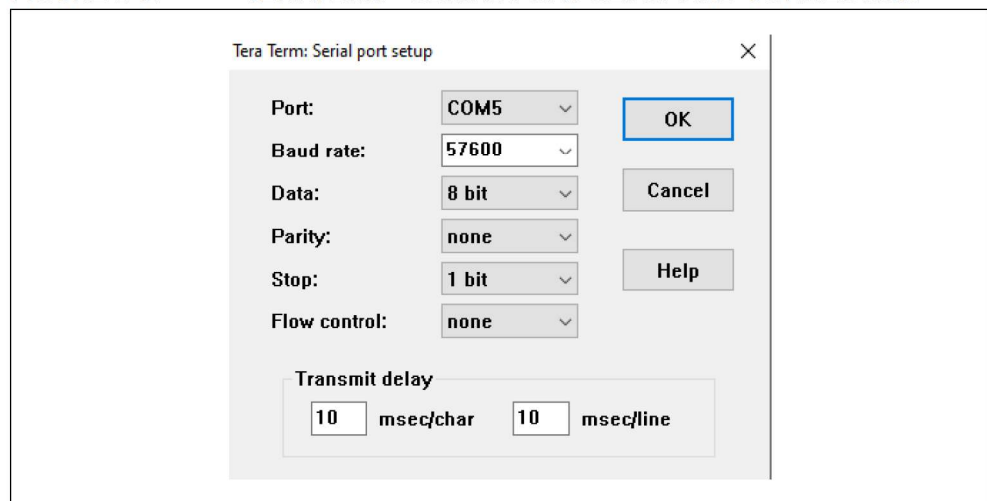

4. Press <Enter>. The CLI runs.

**FIGURE 2-4: TERATERM - CLI**

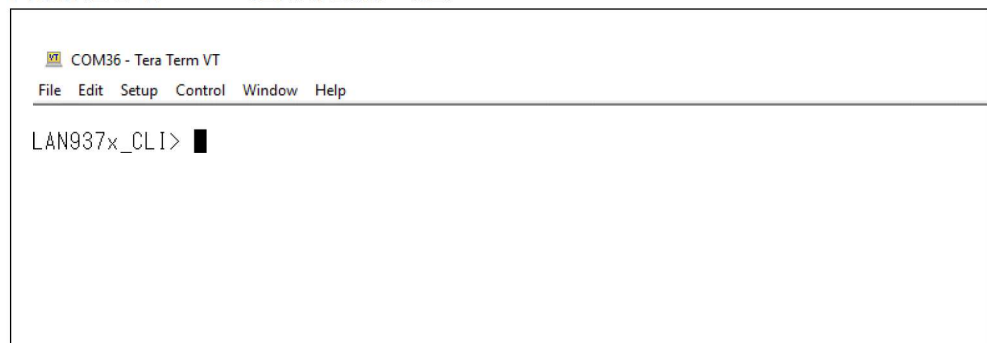

# EVB-LAN9370 Evaluation Board User's Guide

## 2.4 PORT NUMBERING

FIGURE 2-5: EVB-LAN9370 PORT NUMBERING

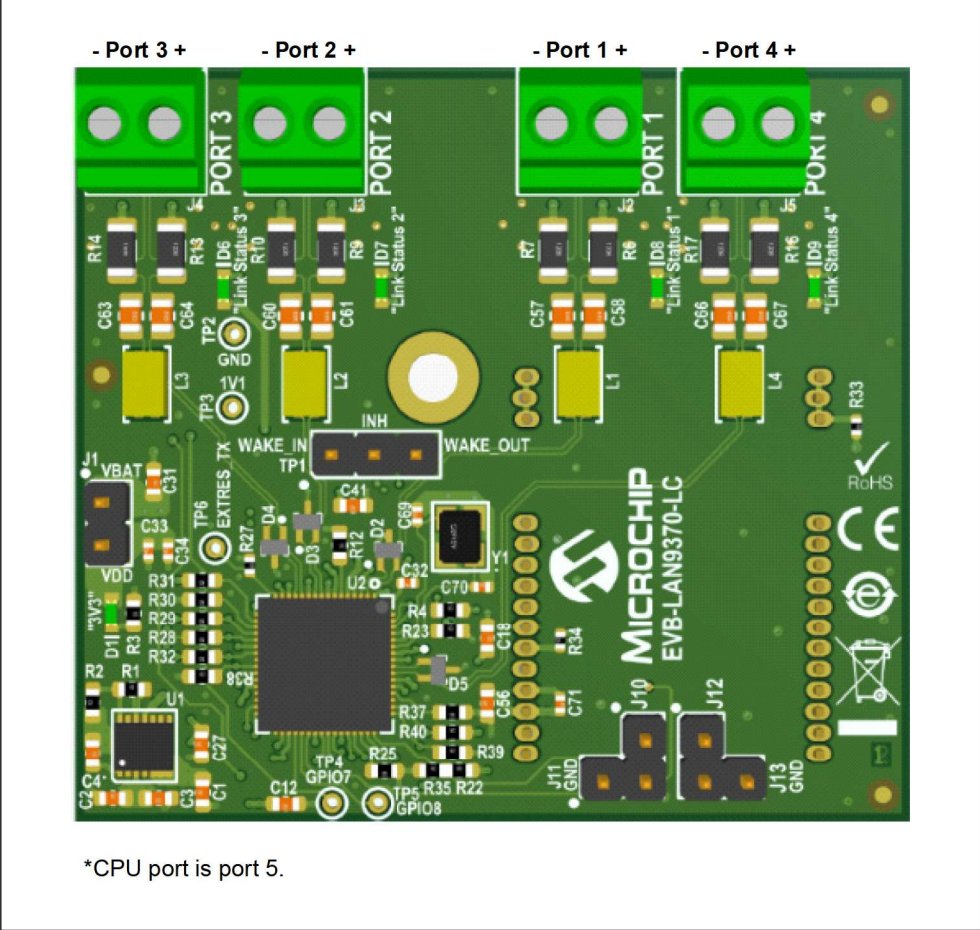



## 2.5 USEFUL COMMANDS

```
LAN937x_CLI> help
```

```
...
```

Check or set T1 clock driver state (on port 1):

```
LAN937x_CLI>sys
```

```
sys> cat sw1/1_master
```

```
1 (on)
```

```
Sys>echo 0 > sw1/1_master
```

```
cat sw1/1_master
```

```
0 (off)
```

```
Sys>q
```

Check link state:

```
LAN937x_CLI> Portstat
```

```
sw> list
```

```
1: 100 2 0
```

```
2: 100 2 0
```

```
3: unlinked
```

```
4: unlinked
```

<b>Note:</b> For a full list of commands, see the <i>LAN937x_RTOS User Guide</i> .
--

# EVB-LAN9370 Evaluation Board User's Guide

---

---

NOTES:

## Chapter 3. Hardware Configuration

### 3.1 INTRODUCTION

Figure 3-1 shows the top view of the evaluation board. The 100BASE-T1 ports connect to the screw terminals on the top of the board.

**Note:** 100BASE-T1 links must always be statically configured with one end as clock driver and the other end as clock receiver. If both ends are the same type, the connection will not work.

By default, the 100BASE-T1 ports are configured as clock receiver. See Section 2.5 “Useful Commands” to change between clock driver and clock receiver.

**FIGURE 3-1: EVB-LAN9370 EVALUATION BOARD (TOP VIEW)**

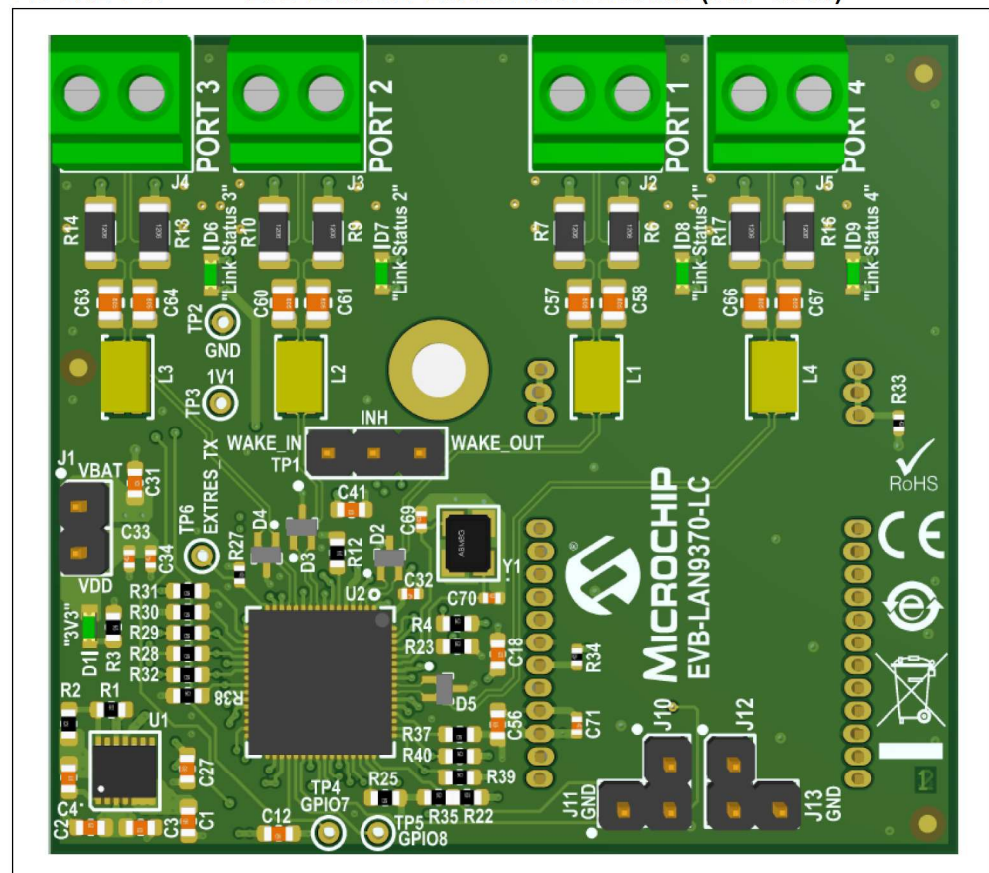

# EVB-LAN9370 Evaluation Board User's Guide

---

## 3.1.1 LED Indicators

Table 3-1 describes the LED indicators on the EVB-LAN9370.

**TABLE 3-1: EVB-LAN9370 LED INDICATOR DESCRIPTIONS**

LED	Description
D1	"VDD Main" = 3.3V power, green
D6	"Link" indicates link status on port 3, green
D7	"Link" indicates link status on port 2 or pps output, green
D8	"Link" indicates link status on port 1 or pps output, green
D9	"Link" indicates link status on port 4, green

## 3.1.2 Jumpers

Table 3-2 describes the jumpers on the EVB-LAN9370.

**TABLE 3-2: EVB-LAN9370 JUMPER DESCRIPTIONS**

Jumper	Description
J1	In-line jumper on the VBAT power rail for VBAT current measurement. Always close it for operation.
J10	Link LED connection for port 1. Close to connect LED.
J11	PPS measurement pin header for LED1
J12	Link LED connection for port 2. Close to connect LED.
J13	PPS measurement pin header for LED2

## 3.1.3 Headers/Test Points

Table 3-3 describes the headers/test points on the EVB-LAN9370.

**TABLE 3-3: EVB-LAN9370 HEADER/TEST POINT DESCRIPTIONS**

Header/Test Point	Description
TP1-1	WAKE_IN, used to wake up the switch when in Sleep mode
TP1-2	INH, indicates Sleep mode is entered on all ports
TP1-3	WAKE_OUT, used by SW to generate wake-up pulse
TP2	GND
TP3	1.1V power
TP4	GPIO7/LED7
TP5	GPIO8/LED8
TP6	EXTRES_TX, reference resistor for T1 interfaces

# Hardware Configuration

## 3.1.4 Connector Descriptions

Table 3-4 describes the connectors included on the PCB.

**TABLE 3-4: EVB-LAN9370 CONNECTOR DESCRIPTIONS**

Pin Number	Signal Name	Description
J7-1	EGND	Ground
J7-2	EGND	Ground
J7-3	EGND	Ground
J9-1	TXEN	RMII enable input
J9-2	TXD0	RMII data 0 input
J9-3	TXD1	RMII data 1 input
J9-4	SPI MOSI	SPI data input
J9-5	SPI MISO	SPI data output
J9-6	GND	Ground
J9-7	VBATR	VBAT input
J9-8	CLK	RMII clock
J9-9	GND	Ground
J9-10	+3.3V	3.3V power input
J9-11	GPIO = nSPI_EN	SPI enable input
J9-12	SPCK	SPI clock input
J6-1	EGND	Ground
J6-2	EGND	Ground
J6-3	EGND	Ground
J8-1	GPIO = WAKE_IN	WAKE input
J8-2	GPIO = INH	INH, indicates all ports are on sleep mode
J8-3	RXD1	RMII data 1 output
J8-4	RXD0	RMII data 0 output
J8-5	RXER	RMII error input
J8-6	CRS_DV	RMII Carrier Sense/Receive Data Valid
J8-7	MDC	MIIM clock
J8-8	MDIO	MIIM data
J8-9	nINT	Interrupt output, active low
J8-10	nRST	Reset input, active low
J8-11	N-u	Not used
J8-12	N-u	Not used



# EVB-LAN9370 Evaluation Board User's Guide

---

---

NOTES:



## **Appendix A. Schematics**

---

---

### **A.1 INTRODUCTION**

This appendix shows the EVB-LAN9370 Evaluation Board schematics.

# EVB-LAN9370 Evaluation Board User's Guide

FIGURE A-1: EVB-LAN9370 SCHEMATIC 1

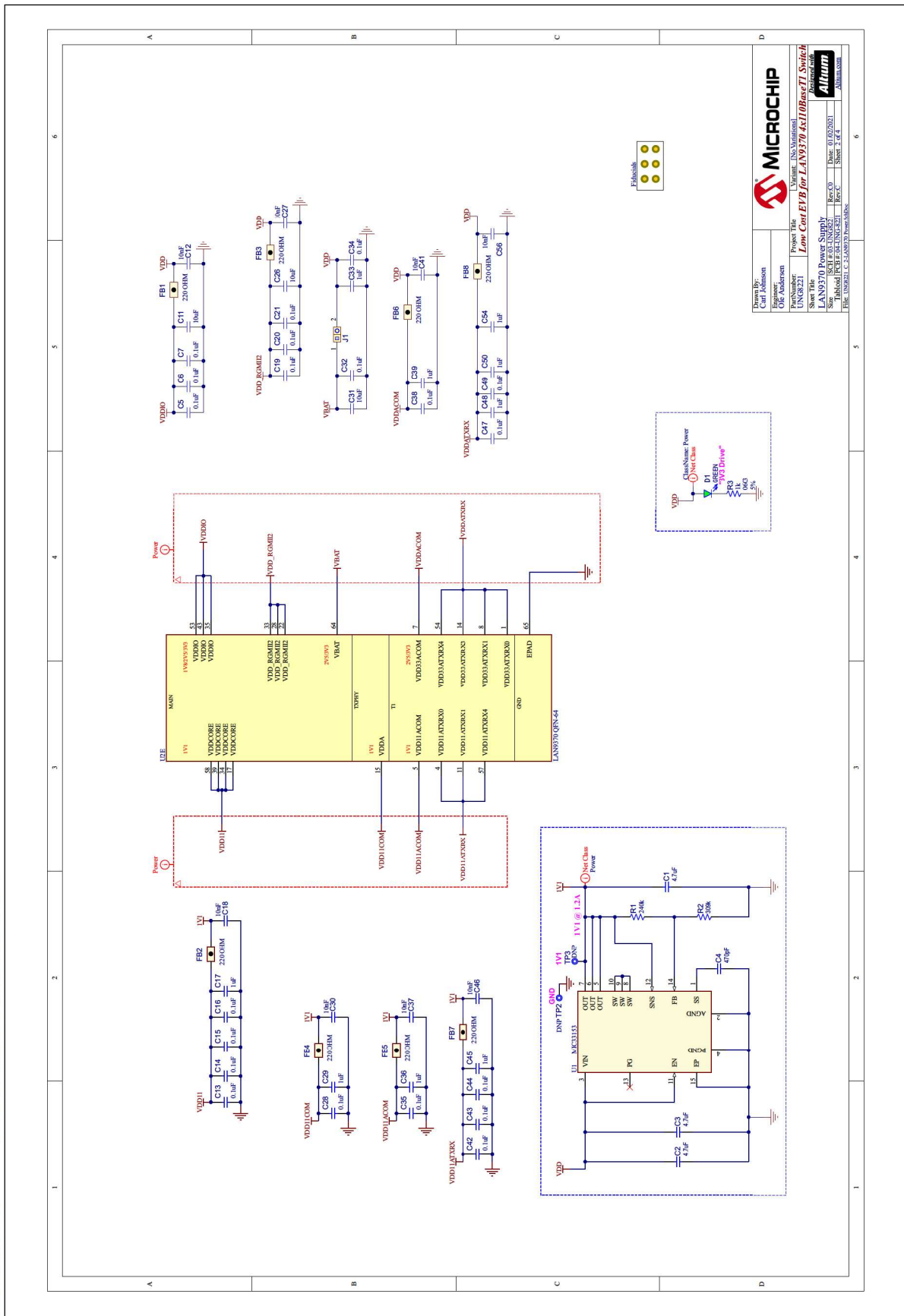

Company Name	Microchip
Part Number	LAN9370 Power Supply
Rev. C	01/02/2021
Sheet 1 of 1	20/01/2021
Project Title	LAN9370 Power Supply
Author	OC Andersen
Version	1.0
Project File	LAN9370 Power Supply
Sheet Title	LAN9370 Power Supply
Sheet 1 of 1	20/01/2021
Rev. C	01/02/2021
Sheet 1 of 1	20/01/2021

Microchip  
LAN9370 Power Supply

Rev. C 01/02/2021

Sheet 1 of 1

20/01/2021

OC Andersen

1.0

LAN9370 Power Supply

01/02/2021

20/01/2021

OC Andersen

1.0

LAN9370 Power Supply

01/02/2021

20/01/2021

OC Andersen

1.0

LAN9370 Power Supply

01/02/2021

20/01/2021

OC Andersen

1.0

LAN9370 Power Supply

01/02/2021

20/01/2021

OC Andersen

1.0

LAN9370 Power Supply

01/02/2021

20/01/2021

OC Andersen

1.0

LAN9370 Power Supply

01/02/2021

20/01/2021

OC Andersen

**FIGURE A-2: EVB-LAN9370 SCHEMATIC 2**

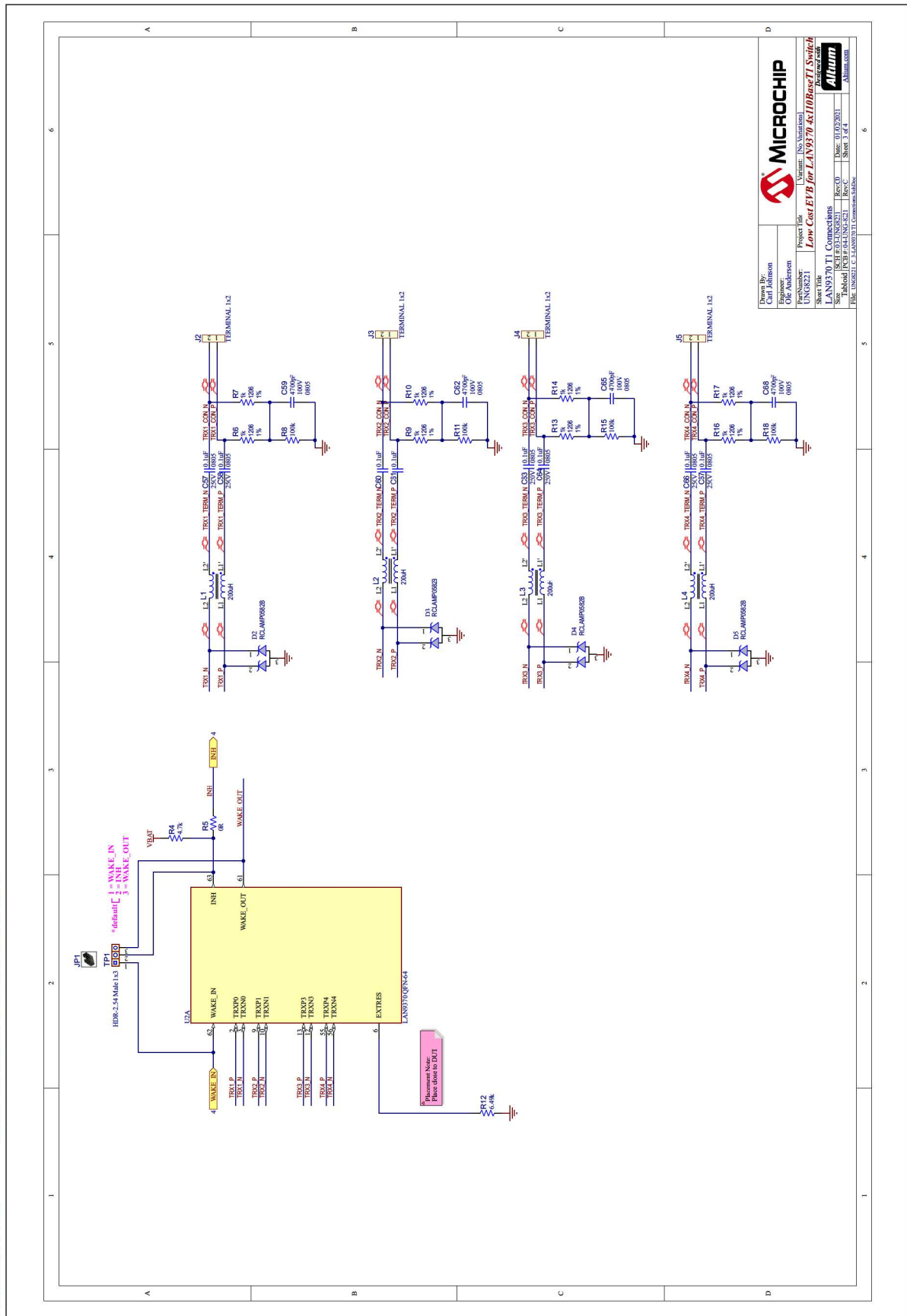

# EVB-LAN9370 Evaluation Board User's Guide

FIGURE A-3: EVB-LAN9370 SCHEMATIC 3

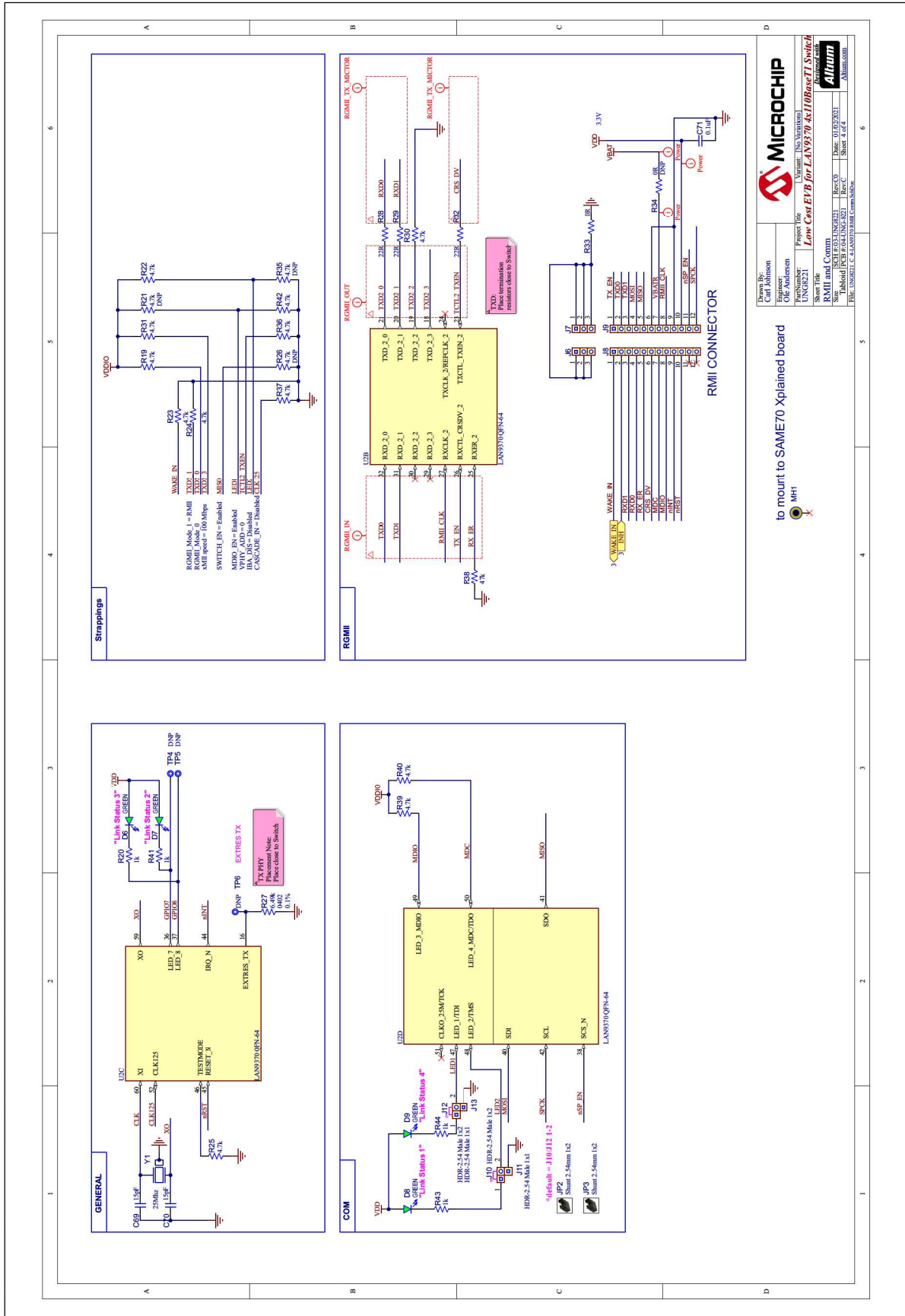

Drawn By: Carl Johnson  
 Checked By: Ove Andersen  
 Project No: UNGR221  
 Variant: NIS Variation  
 Sheet No: 4 of 4  
 Date: 01/02/2021  
 Title: Low Cost EFB for LAN9370 4x10Base-T1 Switch

**MICROCHIP**  
 Atmel Corporation  
 360 Taunton Road  
 Taunton, MA 01960-5000  
 USA  
 Tel: 508-875-7200  
 Fax: 508-875-7201  
 Email: microchip@microchip.com  
 Website: www.microchip.com

to mount to SAME70 Xplained board

MH1

FIG. 105891 (1.4) 0059370101.com/Schematic





## **Appendix B. Bill of Materials**

---

---

### **B.1 INTRODUCTION**

This appendix contains the EVB-LAN9370 Evaluation Board Bill of Materials (BOM).

# EVB-LAN9370 Evaluation Board User's Guide

**TABLE B-1: EVB-LAN9370 BILL OF MATERIALS**

Item	Qty	Reference	Description	Populated	Manufacturer	Manufacturer Part Number
1	3	C1, C2, C3	CAP CER 4.7uF 10V 10% X5R SMD 0603	Yes	KEMET	C0603C475K8PACTU
2	1	C4	CAP CER 470pF 25V 5% NP0 SMD 0603	Yes	AVX	06033A471JAT2A
3	21	C5, C6, C7, C13, C14, C15, C16, C19, C20, C21, C28, C32, C34, C35, C38, C42, C43, C44, C47, C49, C71	CAP CER 0.1uF 50V 10% X7R SMD 0402	Yes	TDK Corporation	C1005X7R1H104K050BB
4	3	C11, C26, C31	CAP CER 10uF 25V 20% X5R SMD 0603	Yes	Murata Electronics North America	GRM188R61E106MA73D
5	8	C12, C18, C27, C30, C37, C41, C46, C56	CAP CER 10000pF (0.01uF, 10nF) 5CV 10% X7R SMD 0603	Yes	KEMET	C0603C103K5RACTU
6	9	C17, C29, C33, C36, C39, C45, C48, C50, C54	CAP CER 1uF 35V 10% X5R SMD 0402	Yes	Murata Electronics North America	GRM155R6YA105KE11D
7	8	C57, C58, C60, C61, C63, C64, C66, C67	CAP CER 0.1uF 250V 10% X7T SMD 0805	Yes	TDK Corporation	C2012X7T2E104K125AA
8	4	C59, C62, C65, C68	CAP CER 47000pF 100V 10% X7R SMD 0805	Yes	TDK Corporation	C2012X7R2A472K
9	2	C69, C70	CAP CER 15pF 50V 5% NP0 SMD 0402	Yes	Murata	GRM1555C1H150JA01D
10	5	D1, D6, D7, D8, D9	DIO LED GREEN 2V 30mA 35mcd Clear SMD 0603	Yes	Lite-On Inc	LTST-C191KGTK
11	4	D2, D3, D4, D5	DIO TVS ARRAY RCLAMP0582BQCTCT 5V 300W SMD SC-75-3	Yes	Semtech Corporation	RCLAMP0582BQCTCT
12	8	FB1, FB2, FB3, FB4, FB5, FB6, FB7, FB8	FERRITE 500mA 220R SMD 0603	Yes	Murata Electronics North America	BLM18AG221SN1D
13	3	J1, J10, J12	CON HDR-2.54 Male 1x2 Gold 5.84MH TH VERT	Yes	FCI	77311-118-02LF
14	4	J2, J3, J4, J5	CON TERMINAL 3.5mm 1x2 Female 16-28AWG 6A TH R/A	Yes	On Shore Technology Inc	ED555/2DS
15	2	J6, J7	CON HDR-1.27 Male 1x3 GOLD 3.0MH TH VERT	Yes	Sullins Connector Solutions	GRP03031VWVN-RC
16	2	J8, J9	CON HDR-1.27 Male 1x12 GOLD 3.0MH TH VERT	Yes	Sullins Connector Solutions	GRP121VWVN-RC
17	2	J11, J13	CON HDR-2.54 Male 1x1 Gold 5.84MH TH VERT	Yes	Samtec Inc.	TSW-101-07-S-S
18	4	L1, L2, L3, L4	CM CHOKE 5.5R@100KHZ 200UH SMD 3.2X2.5MM	Yes	TDK Corporation	ACT1210L-201-2P-TL00
19	1	R1	RES TKF 240k 1% 1/10W SMD 0603	Yes	Panasonic Electronic Components	ERJ-3EKF2403V
20	1	R2	RES TKF 309k 1% 1/4W SMD 0603	Yes	Panasonic	ERJPA3F3093V
21	5	R3, R20, R41, R43, R44	RES TKF 1k 5% 1/10W SMD 0603	Yes	Panasonic	ERJ-3GEYJ102V
22	14	R4, R19, R22, R23, R24, R25, R30, R31, R36, R37, R38, R39, R40, R42	RES TKF 4.7k 5% 1/10W SMD 0603	Yes	Panasonic	ERJ-3GEYJ472V
23	2	R5, R33	RES TKF 0R SMD 0402 AEC-Q200, RES TKF 0R SMD 0402	Yes	Panasonic	ERJ-2GE0R00X
24	8	R6, R7, R9, R10, R13, R14, R16, R17	RES TF 1k 1% 1/2W SMD 1206	Yes	Stackpole Electronics Inc.	RNCP1206FTD1K00
25	4	R8, R11, R15, R18	RES TKF 100k 1% 1/4W SMD 0603	Yes	Vishay	CRCW0603100KFKEAHP
26	1	R12	RES TKF 6.49k 1% 1/16W SMD 0603	Yes	Panasonic	ERJ-3EKF6491V
27	1	R27	RES TKF 6.49k 0.1% 1/16W SMD 0402	Yes	Panasonic Electronic Components	ERA-2ARB6491X
28	3	R28, R29, R32	RES TKF 22R 1% 1/10W SMD 0603	Yes	Panasonic Electronic Components	ERJ-3EKF22R0V
29	1	TP1	CON HDR-2.54 Male 1x3 Tin 5.84MH TH VERT	Yes	Samtec	TSW-103-07-T-S
30	1	Y1	CRYSTAL 25MHz 10pF SMD ABM8G	Yes	Abraco LLC	ABM8G-25.000MHZ-B4Y-T
31	1	U1	MCHP ANALOG SWITCHER Buck 0.6V to 3.6V MIC33153YHU-TR VFDFN-14	Yes	Microchip Technology	MIC33153YHU-TR

**TABLE B-1: EVB-LAN9370 BILL OF MATERIALS (CONTINUED)**

Item	Qty	Reference	Description	Populated	Manufacturer	Manufacturer Part Number
32	1	U2	MCHP INTERFACE ETHERNET LAN9370 QFN-64	Yes	Microchip Production	MIC8180
33	3	JP1, JP2, JP3	MECH HW JUMPER 2.54mm 1x2	MECH	3M	969102-0000-DA
34	1	PCB1	Printed Circuit Board	PCB		<b>04-UNG-8221-RC</b>
35	3	R21, R26, R35	RES TKF 4.7k 5% 1/10W SMD 0603	DNP	Panasonic	ERJ-3GEYJ472V
36	1	R34	RES TKF 0R SMD 0402	DNP	Panasonic	ERJ-2GE0R00X

# EVB-LAN9370 Evaluation Board User's Guide

---

---

NOTES:

---

---

**NOTES:**





# MICROCHIP

## Worldwide Sales and Service

### AMERICAS

**Corporate Office**  
2355 West Chandler Blvd.  
Chandler, AZ 85224-6199  
Tel: 480-792-7200  
Fax: 480-792-7277  
Technical Support:  
[http://www.microchip.com/  
support](http://www.microchip.com/support)  
Web Address:  
[www.microchip.com](http://www.microchip.com)

#### Atlanta

Duluth, GA  
Tel: 678-957-9614  
Fax: 678-957-1455

#### Austin, TX

Tel: 512-257-3370

#### Boston

Westborough, MA  
Tel: 774-760-0087  
Fax: 774-760-0088

#### Chicago

Itasca, IL  
Tel: 630-285-0071  
Fax: 630-285-0075

#### Dallas

Addison, TX  
Tel: 972-818-7423  
Fax: 972-818-2924

#### Detroit

Novi, MI  
Tel: 248-848-4000

#### Houston, TX

Tel: 281-894-5983

#### Indianapolis

Noblesville, IN  
Tel: 317-773-8323  
Fax: 317-773-5453  
Tel: 317-536-2380

#### Los Angeles

Mission Viejo, CA  
Tel: 949-462-9523  
Fax: 949-462-9608  
Tel: 951-273-7800

#### Raleigh, NC

Tel: 919-844-7510

#### New York, NY

Tel: 631-435-6000

#### San Jose, CA

Tel: 408-735-9110  
Tel: 408-436-4270

#### Canada - Toronto

Tel: 905-695-1980  
Fax: 905-695-2078

### ASIA/PACIFIC

**Australia - Sydney**  
Tel: 61-2-9868-6733

**China - Beijing**  
Tel: 86-10-8569-7000

**China - Chengdu**  
Tel: 86-28-8665-5511

**China - Chongqing**  
Tel: 86-23-8980-9588

**China - Dongguan**  
Tel: 86-769-8702-9880

**China - Guangzhou**  
Tel: 86-20-8755-8029

**China - Hangzhou**  
Tel: 86-571-8792-8115

**China - Hong Kong SAR**  
Tel: 852-2943-5100

**China - Nanjing**  
Tel: 86-25-8473-2460

**China - Qingdao**  
Tel: 86-532-8502-7355

**China - Shanghai**  
Tel: 86-21-3326-8000

**China - Shenyang**  
Tel: 86-24-2334-2829

**China - Shenzhen**  
Tel: 86-755-8864-2200

**China - Suzhou**  
Tel: 86-186-6233-1526

**China - Wuhan**  
Tel: 86-27-5980-5300

**China - Xian**  
Tel: 86-29-8833-7252

**China - Xiamen**  
Tel: 86-592-2388138

**China - Zhuhai**  
Tel: 86-756-3210040

### ASIA/PACIFIC

**India - Bangalore**  
Tel: 91-80-3090-4444

**India - New Delhi**  
Tel: 91-11-4160-8631

**India - Pune**  
Tel: 91-20-4121-0141

**Japan - Osaka**  
Tel: 81-6-6152-7160

**Japan - Tokyo**  
Tel: 81-3-6880-3770

**Korea - Daegu**  
Tel: 82-53-744-4301

**Korea - Seoul**  
Tel: 82-2-554-7200

**Malaysia - Kuala Lumpur**  
Tel: 60-3-7651-7906

**Malaysia - Penang**  
Tel: 60-4-227-8870

**Philippines - Manila**  
Tel: 63-2-634-9065

**Singapore**  
Tel: 65-6334-8870

**Taiwan - Hsin Chu**  
Tel: 886-3-577-8366

**Taiwan - Kaohsiung**  
Tel: 886-7-213-7830

**Taiwan - Taipei**  
Tel: 886-2-2508-8600

**Thailand - Bangkok**  
Tel: 66-2-694-1351

**Vietnam - Ho Chi Minh**  
Tel: 84-28-5448-2100

### EUROPE

**Austria - Wels**  
Tel: 43-7242-2244-39  
Fax: 43-7242-2244-393

**Denmark - Copenhagen**  
Tel: 45-4485-5910  
Fax: 45-4485-2829

**Finland - Espoo**  
Tel: 358-9-4520-820

**France - Paris**  
Tel: 33-1-69-53-63-20  
Fax: 33-1-69-30-90-79

**Germany - Garching**  
Tel: 49-8931-9700

**Germany - Haan**  
Tel: 49-2129-3766400

**Germany - Heilbronn**  
Tel: 49-7131-72400

**Germany - Karlsruhe**  
Tel: 49-721-625370

**Germany - Munich**  
Tel: 49-89-627-144-0  
Fax: 49-89-627-144-44

**Germany - Rosenheim**  
Tel: 49-8031-354-560

**Israel - Ra'anana**  
Tel: 972-9-744-7705

**Italy - Milan**  
Tel: 39-0331-742611  
Fax: 39-0331-466781

**Italy - Padova**  
Tel: 39-049-7625286

**Netherlands - Drunen**  
Tel: 31-416-690399  
Fax: 31-416-690340

**Norway - Trondheim**  
Tel: 47-7288-4388

**Poland - Warsaw**  
Tel: 48-22-3325737

**Romania - Bucharest**  
Tel: 40-21-407-87-50

**Spain - Madrid**  
Tel: 34-91-708-08-90  
Fax: 34-91-708-08-91

**Sweden - Gothenberg**  
Tel: 46-31-704-60-40

**Sweden - Stockholm**  
Tel: 46-8-5090-4654

**UK - Wokingham**  
Tel: 44-118-921-5800  
Fax: 44-118-921-5820