



Main

Range	TeSys
Product name	TeSys GV4
Device short name	GV4L
Product or component type	Circuit breaker
Device application	Motor
Poles description	3P
Utilisation category	Category A
Trip unit technology	Magnetic
Protection type	Short-circuit
[In] rated current	80 A
Breaking capacity	[Icu] : 100 kA at 220...240 V AC 50/60 Hz according to IEC 60947-2 [Icu] : 50 kA at 380...415 V AC 50/60 Hz according to IEC 60947-2 [Icu] : 50 kA at 440 V AC 50/60 Hz according to IEC 60947-2 [Icu] : 15 kA at 525 V AC 50/60 Hz according to IEC 60947-2 [Icu] : 8 kA at 660...690 V AC 50/60 Hz according to IEC 60947-2 [Icu] : 25 kA at 500 V AC 50/60 Hz according to IEC 60947-2
[Ics] rated service breaking capacity	100 kA : at 220...240 V AC 50/60 Hz according to IEC 60947-2 50 kA : at 380...415 V AC 50/60 Hz according to IEC 60947-2 50 kA : at 440 V AC 50/60 Hz according to IEC 60947-2 25 kA : at 500 V AC 50/60 Hz according to IEC 60947-2 15 kA : at 525 V AC 50/60 Hz according to IEC 60947-2 2 kA : at 660...690 V AC 50/60 Hz according to IEC 60947-2
Magnetic setting range	480...1120 A
Control type	Toggle

Complementary

[Ue] rated operational voltage	690 V AC 50/60 Hz conforming to IEC 60947-2
Motor power kW	22 kW at 400...415 V AC 50/60 Hz 30 kW at 400...415 V AC 50/60 Hz 30 kW at 500 V AC 50/60 Hz 37 kW at 400...415 V AC 50/60 Hz 37 kW at 500 V AC 50/60 Hz

	37 kW at 660...690 V AC 50/60 Hz 45 kW at 500 V AC 50/60 Hz 45 kW at 660...690 V AC 50/60 Hz 55 kW at 500 V AC 50/60 Hz 55 kW at 660...690 V AC 50/60 Hz
[Uimp] rated impulse withstand voltage	8 kV according to IEC 60947-2
[Ui] rated insulation voltage	800 V according to IEC 60947-2
Mounting mode	By screws By clips
Mounting support	Plate 35 mm symmetrical DIN rail 75 mm symmetrical DIN rail
Suitability for isolation	Yes according to IEC 60947-1
Mechanical durability	40000 cycles
Electrical durability	14000 cycles for AC-3 at 440 V In/2 7000 cycles for AC-3 at 440 V In
Local signalling	Green flag for presence of auxiliary contacts
Number of slots	1 slot(s) for alarm switch fault signalling contact (plug-in) 1 slot(s) for voltage release electrical remote tripping (plug-in) 1 slot(s) for auxiliary switch open/close contact (plug-in)
Connection pitch	27 mm
Connections - terminals	Lugs-ring terminals
Tightening torque	9 N.m for 16...95 mm ² 5 N.m for 1.5...10 mm ²
Quality labels	CE
Standards	EN/IEC 60947-2 EN/IEC 60947-4-1
Height	155 mm
Width	81 mm
Depth	116 mm
Product weight	1.5 kg
Colour	Grey RAL 7016

Environment

Product certifications	IEC
Tropicalisation	2 according to IEC 68-2
IP degree of protection	IP40 (front face) according to IEC 60529
IK degree of protection	IK07 according to IEC 62262
Pollution degree	3 according to IEC 60947-1
Mechanical robustness	Shocks 15 Gn for 11 ms according to IEC 60068-2-27 Vibrations +/- 1 mm for 2...13.2 Hz according to IEC 60068-2-6 Vibrations 0.7 gn for 13.2...100 Hz according to IEC 60068-2-6
Ambient air temperature for operation	-25...70 °C
Ambient air temperature for storage	-50...85 °C
Operating altitude	> 2000...5000 m with derating 2000 m without derating

Offer Sustainability

Sustainable offer status	Green Premium product
RoHS (date code: YYWW)	Compliant - since 1736 - Schneider Electric declaration of conformity Schneider Electric declaration of conformity
REACH	Reference not containing SVHC above the threshold Reference not containing SVHC above the threshold
Product environmental profile	Available Product Environmental Profile
Product end of life instructions	Available

Tripping Curves for GV4L and GV4LE Combined with Thermal Overload Relay LRD or LR9

Average Operating Times at 20 °C Related to Multiples of the Setting Current

GV4L02 and GV4LE02 to 12 with LRD05 to LRD14, GV4L80 and GV4LE80 with LRD3363

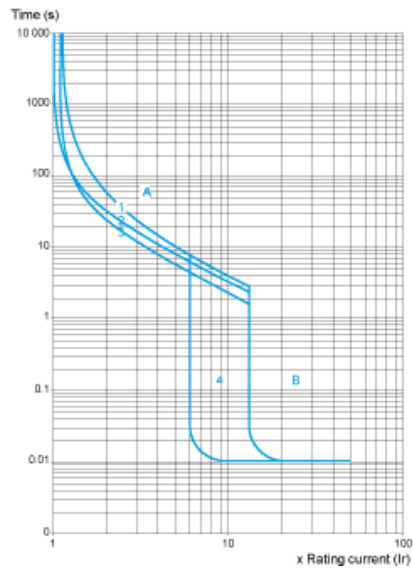

- 1 3 poles from cold state
- 2 2 poles from cold state
- 3 3 poles from hot state
- 4 6...14 Ir
- A Thermal overload relay protection zone
- B GV4L protection zone

GV4L25 and GV4LE25 with LRD 318, LRD325 GV4L50 AND GV4LE50 with LRD 332, LRD 340, LRD 350

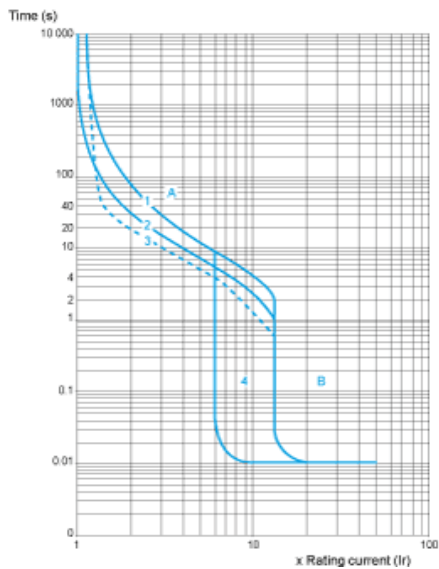

- 1 3 poles from cold state
- 2 2 poles from cold state
- 3 3 poles from hot state
- 4 6...14 Ir
- A Thermal overload relay protection zone
- B GV4L protection zone

GV4L115 and GV4LE115 with Class 10 LR9F5367, LR9D5369 and Class 20 LR9D5567, LR9F5569

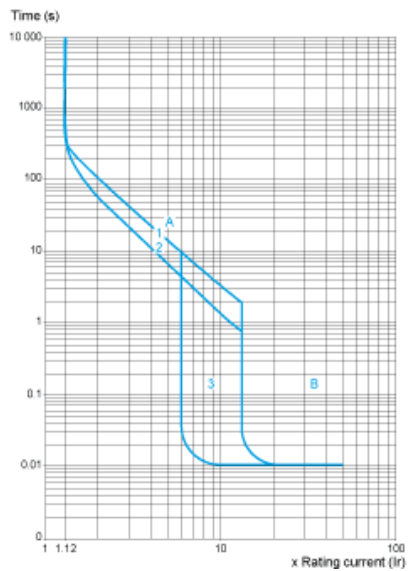

- 1 Cold state curve
- 2 Hot state curve
- 3 6...14 Ir

Current Limitation on Short-Circuit for GV4L, GV4LE (3-Phase 400/415 V)

Dynamic Stress

$I_{peak} = f(\text{prospective } I_{sc}) \text{ at } 1.05 U_e = 435 \text{ V}$

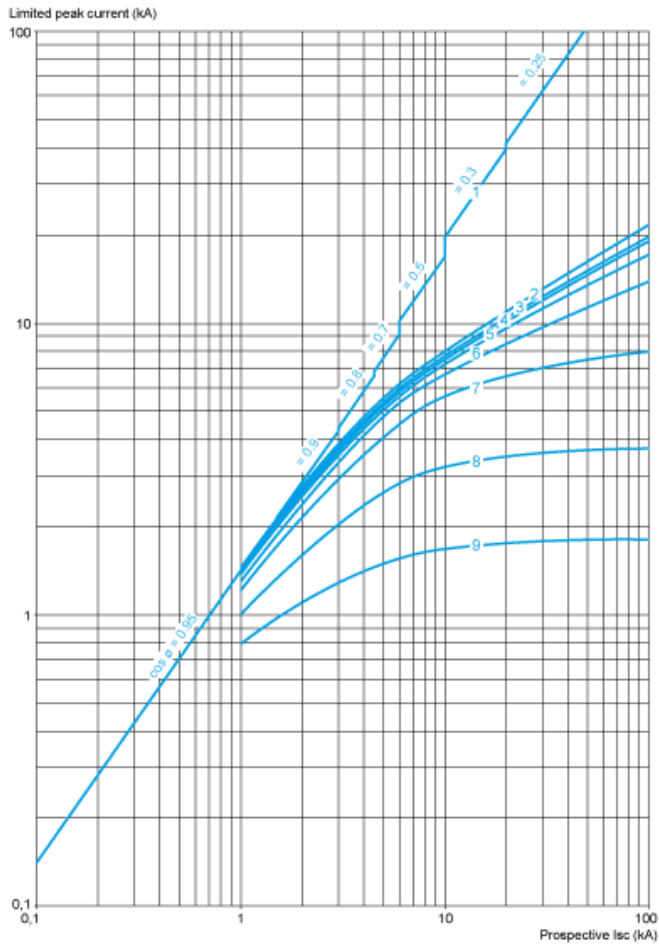

- 1 Maximum peak current
- 2 GV4L115
- 3 GV4L80
- 4 GV4L50
- 5 GV4L25
- 6 GV4L12
- 7 GV4L07
- 8 GV4L03
- 9 GV4L02

Current Limitation on Short-Circuit for GV4L, GV4LE + Thermal Overload Relay LRD or LR9 (3-Phase 400/415 V)

Dynamic Stress

$I_{peak} = f(\text{prospective } I_{sc}) \text{ at } 1.05 U_e = 435 \text{ V}$

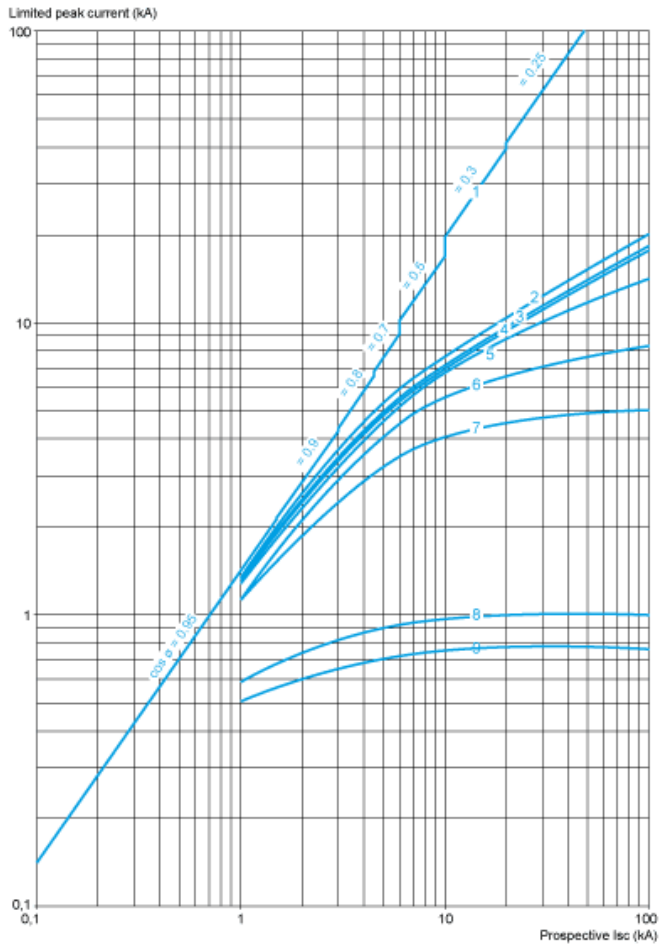

- 1 Maximum peak current
- 2 GV4L115 + LR9D5367 or LR9F5367
- 3 GV4L80 + LRD3361
- 4 GV4L50 + LRD340
- 5 GV4L25 + LRD325
- 6 GV4L12 + LRD313
- 7 GV4L07 + LRD12
- 8 GV4L03 + LRD07
- 9 GV4L02 + LRD07

Thermal Limit on Short-Circuit for GV4L, GV4LE

Thermal Limit in A²s

Sum of $I^2dt = f$ (prospective Isc) at 1.05 Ue = 435 V

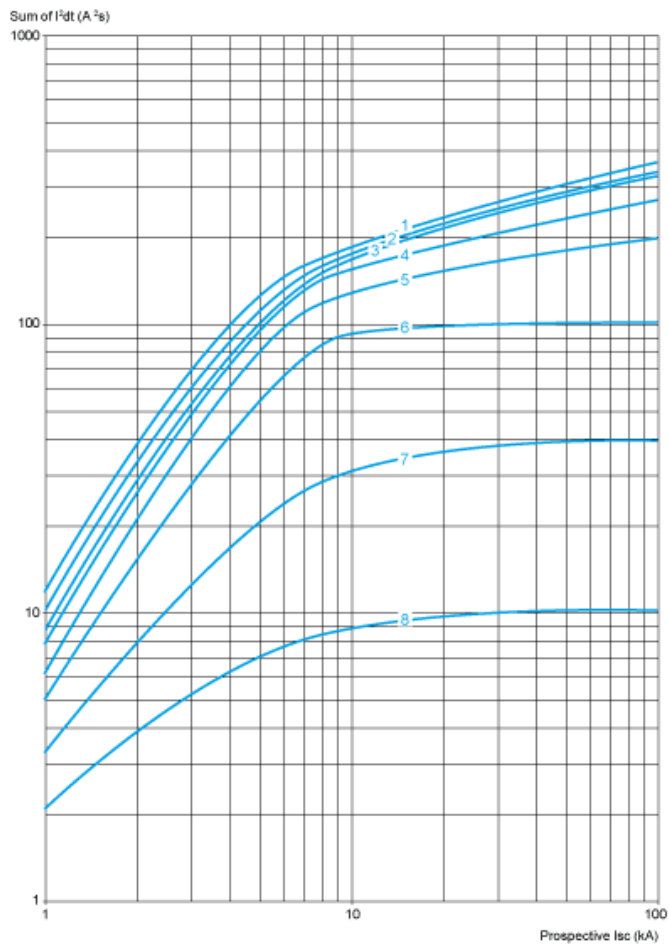

- 1 GV4L115
- 2 GV4L80
- 3 GV4L50
- 4 GV4L25
- 5 GV4L12
- 6 GV4L07
- 7 GV4L03
- 8 GV4L02

Current Limitation on Short-Circuit for GV4L, GV4LE + Thermal Overload Relay LRD or LR9

Thermal Limit in kA in the Magnetic Operating Zone

Sum of $I^2dt = f(\text{prospective Isc})$ at $1.05 U_e = 435 \text{ V}$

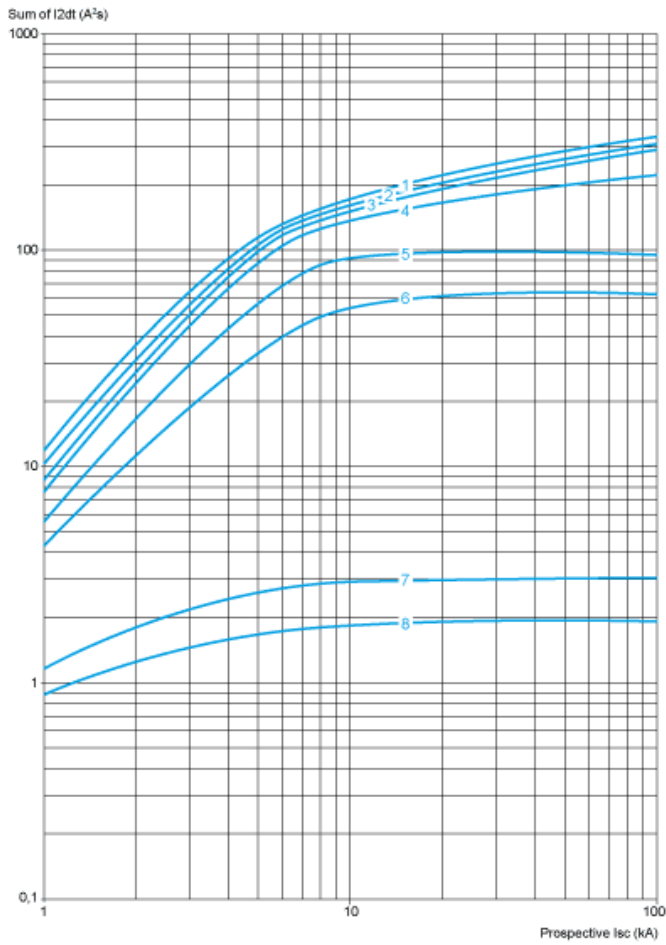

- 1 GV4L115 + LR9D5367 or LR9F5367
- 2 GV4L80 + LRD3361
- 3 GV4L50 + LRD340
- 4 GV4L25 + LRD325
- 5 GV4L12 + LRD313
- 6 GV4L07+ LRD12
- 7 GV4L03+ LRD07
- 8 GV4L02 + LRD07

GV4 with Toggle: GV4LE, GV4PE, GV4PEM

With EverLink® Connector

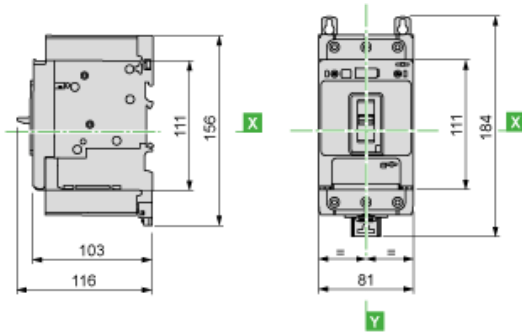

With Crimp Lug Connector

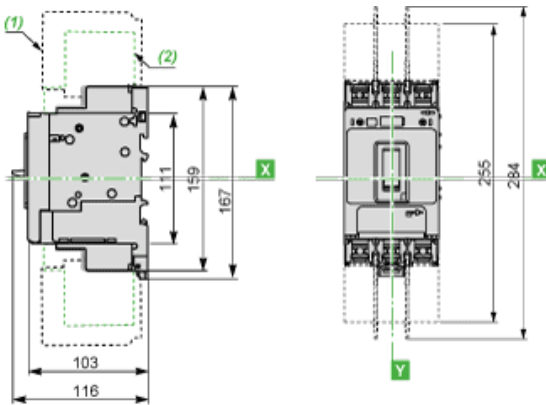

- (1) Interphases barriers
- (2) Long terminal shield

GV4 with Rotary Handle: GV4L, GV4P, or GV4LE, GV4PE, GV4PEM with GV4ADN01, GV4ADN02 Direct Mounting Rotary Handle

Dimensions

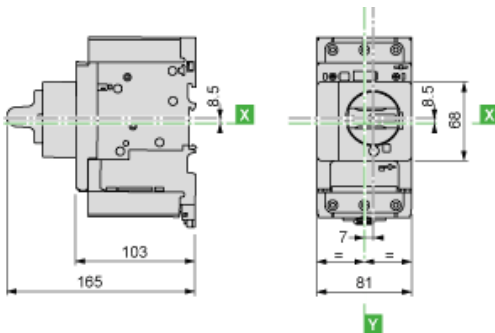

GV4L, GV4P, GV4LE, GV4PE, GV4PEM

Panel Mounting with M4 Screws

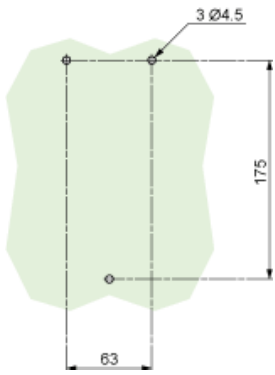

Door Cut-Out for Rotary Handle

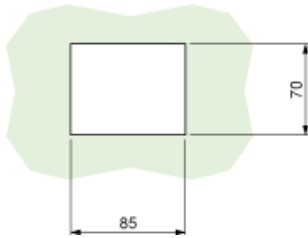

Minimum Safety Clearance

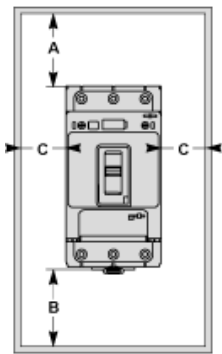

Toggle-type, rotary handle-type: identical clearance values.

Safety Clearance (mm)						
	Painted Sheet Metal			Bare Sheet Metal		
	A	B	C	A	B	C
No accessory	30	0	0	40	0	5
Interphase barriers	0	0	0	0	0	5
Long terminal shield	0	0	0	0	0	5

Magnetic Motor Circuit Breakers

GV4L, GV4LE

