

Part Number: L-57SURKCGKC

Hyper Red
Green

Features

- Low power consumption.
- Long life - solid state reliability.
- RoHS compliant.

Description

The Hyper Red source color devices are made with Al-GaN on GaAs substrate Light Emitting Diode.
The Green source color devices are made with AlGaInP on GaAs substrate Light Emitting Diode.

Package Dimensions

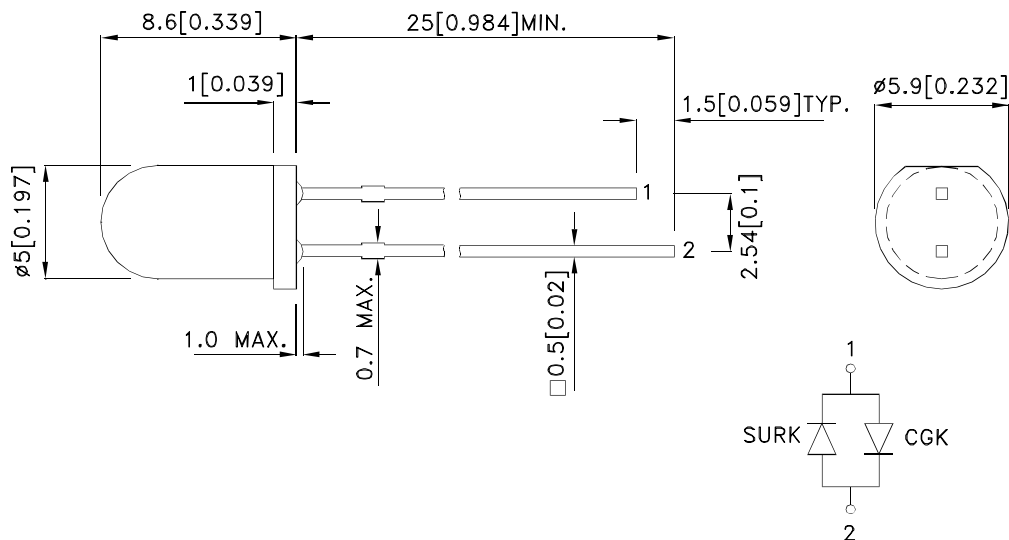

Notes:

1. All dimensions are in millimeters (inches).
2. Tolerance is $\pm 0.25(0.01)$ " unless otherwise noted.
3. Lead spacing is measured where the leads emerge from the package.
4. The specifications, characteristics and technical data described in the datasheet are subject to change without prior notice.



Selection Guide

Part No.	Dice	Lens Type	Iv (mcd) [2] @ 20mA		Viewing Angle [1]
			Min.	Typ.	2θ1/2
L-57SURKCGKC	Hyper Red (AlGaInP)	Water Clear	400	1500	30°
			*150	*450	
	Green (AlGaInP)		100	180	
			*100	*180	

Notes:

1. θ1/2 is the angle from optical centerline where the luminous intensity is 1/2 of the optical peak value.

2. Luminous intensity/ luminous Flux: +/-15%.

* Luminous intensity value is traceable to the CIE127-2007 compliant national standards.

Electrical / Optical Characteristics at TA=25°C

Symbol	Parameter	Device	Typ.		Max.	Units	Test Conditions
λpeak	Peak Wavelength	Hyper Red Green	650 574	*645 *574		nm	IF=20mA
λD [1]	Dominant Wavelength	Hyper Red Green	630 570	*630 *570		nm	IF=20mA
Δλ1/2	Spectral Line Half-width	Hyper Red Green	28 20			nm	IF=20mA
C	Capacitance	Hyper Red Green	35 15			pF	VF=0V;f=1MHz
VF [2]	Forward Voltage	Hyper Red Green	1.95 2.1		2.5 2.5	V	IF=20mA

Notes:

1. Wavelength: +/-1nm.

2. Forward Voltage: +/-0.1V.

* Wavelength value is traceable to the CIE127-2007 compliant national standards.

Absolute Maximum Ratings at TA=25°C

Parameter	Hyper Red	Green	Units
Power dissipation	75	75	mW
DC Forward Current	30	30	mA
Peak Forward Current [1]	185	150	mA
Operating / Storage Temperature	-40°C To +85°C		
Lead Solder Temperature [2]	260°C For 3 Seconds		
Lead Solder Temperature [3]	260°C For 5 Seconds		

Notes:

1. 1/10 Duty Cycle, 0.1ms Pulse Width.

2. 2mm below package base.

3. 5mm below package base.

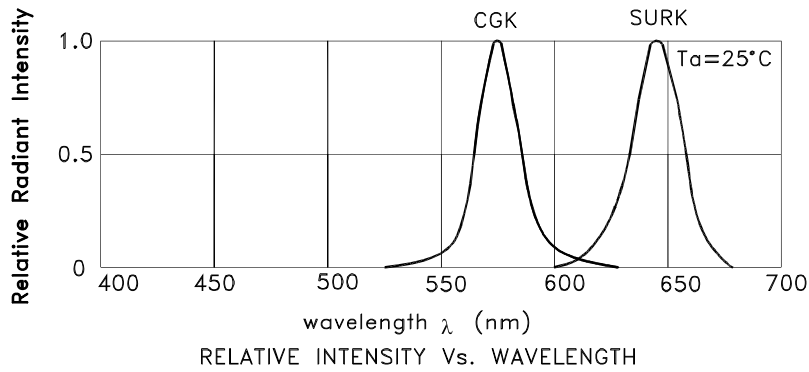

L-57SURKCGKC Hyper Red

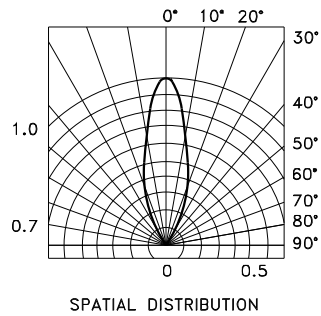
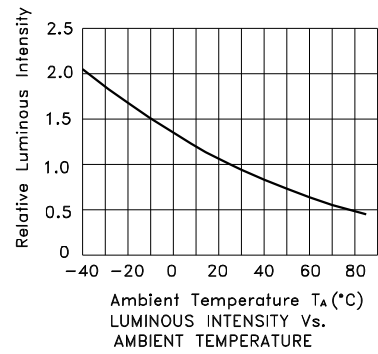
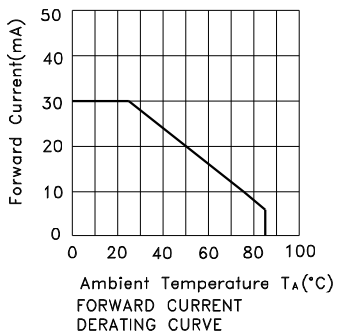
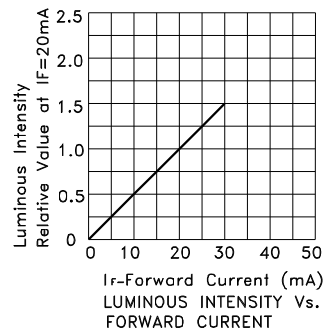
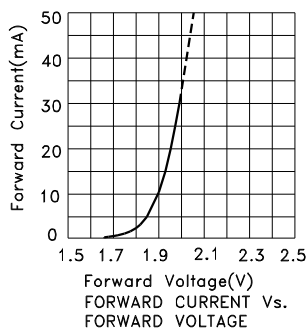

Green

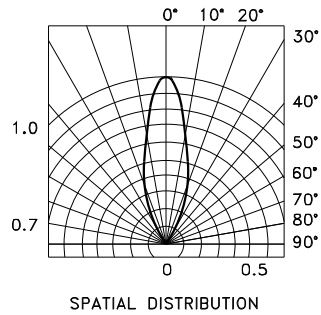
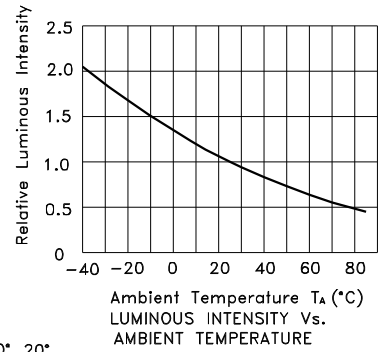
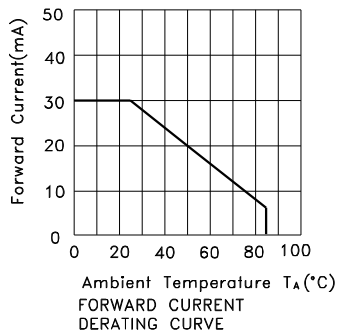

PACKING & LABEL SPECIFICATIONS

L-57SURKCGKC

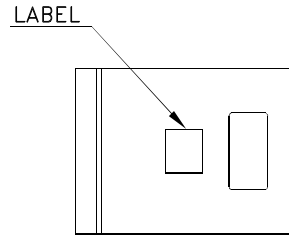
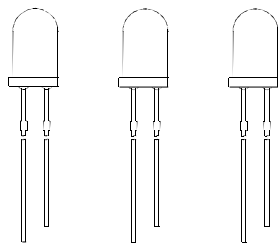

500PCS / BAG



20K / 9# BOX

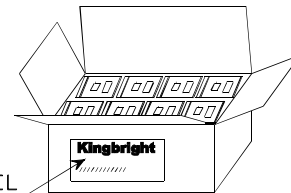

OUTSIDE LABEL

10K / 5# BOX

<h2 style="margin: 0;">Kingbright</h2>	
P/NO: L-57xxx	
QTY: 500 pcs	Q.C.
S/N: XXXX	<div style="border: 1px solid black; border-radius: 50%; padding: 5px; display: inline-block;"> Q C xx xx xxxx PASSED </div>
CODE: XXX	
LOT NO:	
XXXXXXXXXXXXXXXXXXXXXXXX RoHS Compliant	

PRECAUTIONS

1. The lead pitch of the LED must match the pitch of the mounting holes on the PCB during component placement. Lead-forming may be required to insure the lead pitch matches the hole pitch. Refer to the figure below for proper lead forming procedures. (Fig. 1)

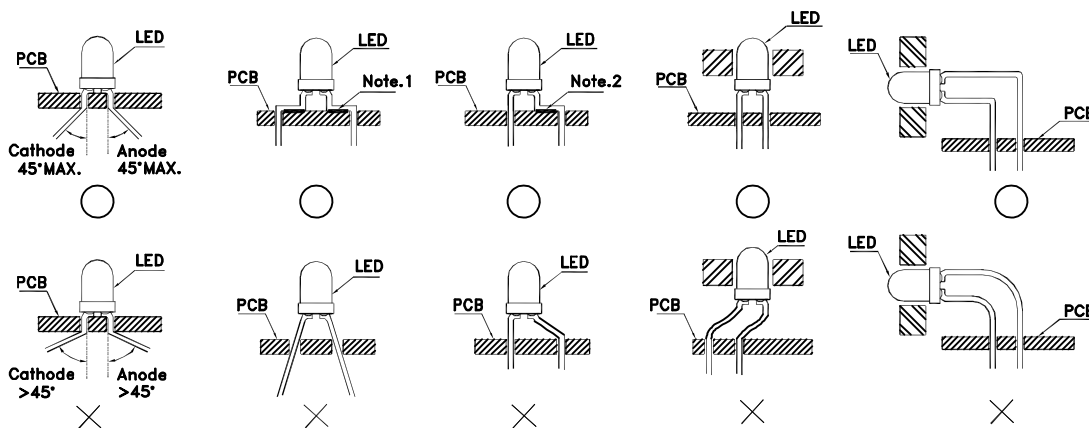

Fig.1

”○” Correct mounting method ”×” Incorrect mounting method

2. When soldering wire to the LED, use individual heat-shrink tubing to insulate the exposed leads to prevent accidental contact short-circuit. (Fig.2)

3. Use stand-offs (Fig.3) or spacers (Fig.4) to securely position the LED above the PCB.

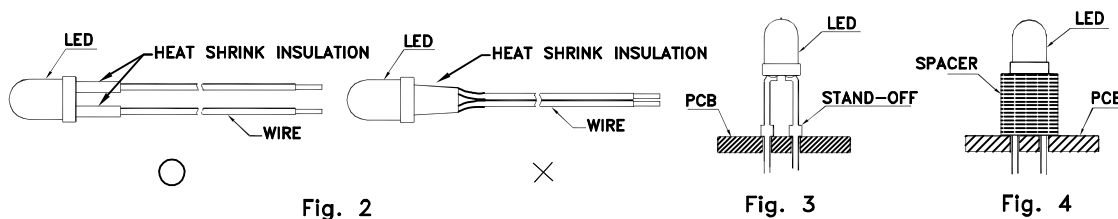

Fig. 2

Fig. 3

Fig. 4

4. Maintain a minimum of 2mm clearance between the base of the LED lens and the first lead bend. (Fig. 5 and 6)
5. During lead forming, use tools or jigs to hold the leads securely so that the bending force will not be transmitted to the LED lens and its internal structures. Do not perform lead forming once the component has been mounted onto the PCB. (Fig. 7)

6. Do not bend the leads more than twice. (Fig. 8)

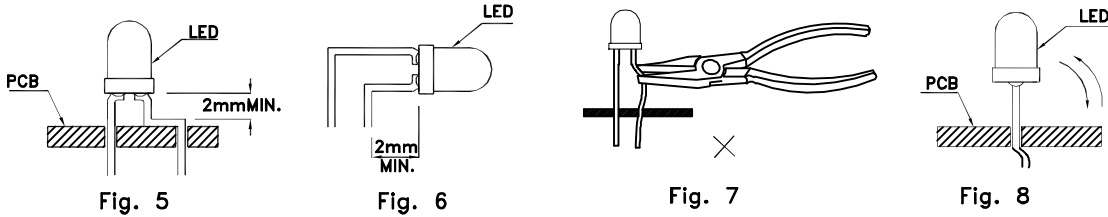

7. During soldering, component covers and holders should leave clearance to avoid placing damaging stress on the LED during soldering.

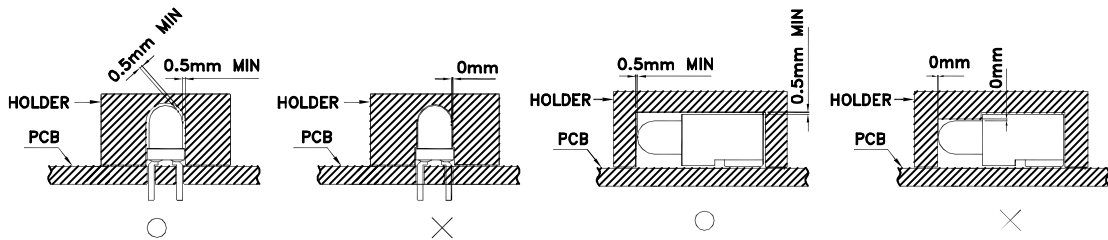

8. The tip of the soldering iron should never touch the lens epoxy.

9. Through-hole LEDs are incompatible with reflow soldering.

10. If the LED will undergo multiple soldering passes or face other processes where the part may be subjected to intense heat, please check with Kingbright for compatibility.

11. Recommended Wave Soldering Profile for Kingbright Thru-Hole Products

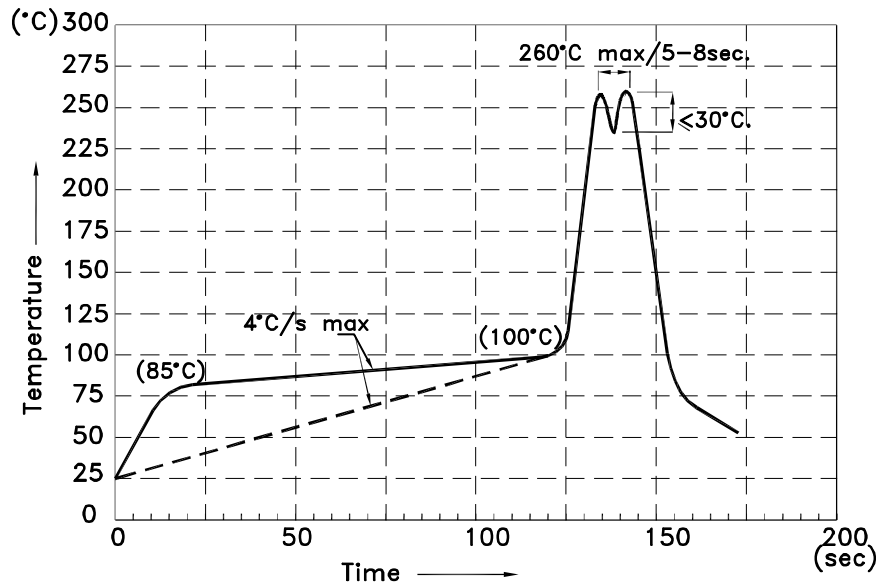

Notes:

1. Recommend the solder wave peak temperature kept between 245~260°C, The maximum soldering temperature should not exceed 260°C.
2. Do not apply stress to the epoxy body while the temperature is above 85°C.
3. During the wave soldering process, the preheat temperature must not exceed 100°C.
4. Fixtures should not place stress on the component when mounted.
5. No more than one soldering pass.