



Model Number

RMS-M-RC

Radar sensor

Features

- Microwave motion sensor with basic functionality
- Reliable detection of people and vehicles
- Simplest adjustment of the sensing range
- Easily programmable
- Programmable by remote control

Product information

An effective opening of doors or industrial doors can be achieved very flexibly with the RMS microwave motion sensor series. The RC versions offer remote-controlled adjustment of parameters. Ultramodern microcontroller evaluation technology guarantees a variety of field sizes and universal use even in difficult conditions. An integrated microprocessor with 24 GHz-microwave technology ensures high reliability even under difficult usage conditions. The sensor also offers two adjustable detection areas and different operating modes, an installation height up to 4 m and operates in a temperature range of -20 ... +60 °C.

Dimensions

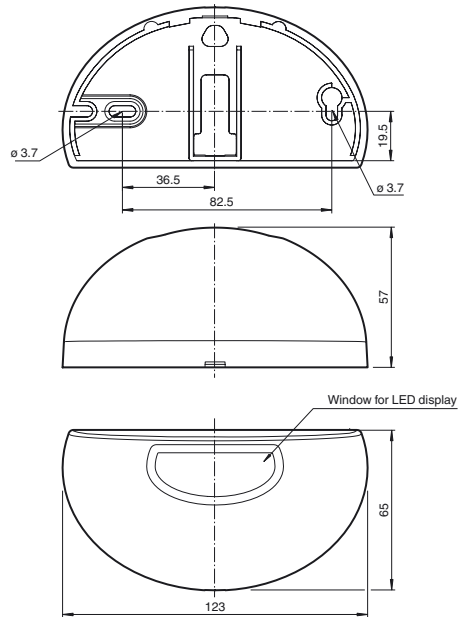

Electrical connection

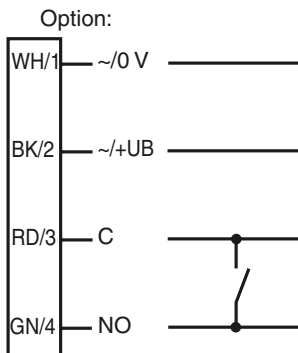

Indicators/operating means

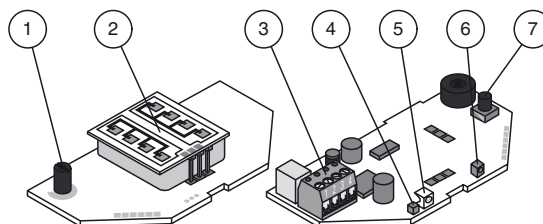

1	Potentiometer
2	Antenna
3	Terminal
4	IR-transmitter (RC version only)
5	LED (red/green)
6	IR-receiver (RC version only)
7	Programming button

Release date: 2017-11-28 09:40 Date of issue: 2017-11-28 19:4554_eng.xml

Technical data

General specifications

Sensing range	broad: 2000x 4500 mm (DxW) at 2200 mm mounting height and 30° tilt angle narrow: 4500x 2000 mm (DxW) at 2200 mm mounting height and 30° tilt angle
Function principle	Microwave module
Detection speed	min. 0.1 m/s
Setting angle	0 ... 40 ° in 5 ° increments
Operating frequency	24.15 ... 24.25 GHz K-Band
Operating mode	Radar motion sensor
Transmitter radiated power (EIRP)	< 20 dBm

Functional safety related parameters

MTTF _d	850 a
Mission Time (T _M)	20 a
Diagnostic Coverage (DC)	0 %

Indicators/operating means

Function indicator	LED red/green
Control elements	Potentiometer and programming button for setting: Method of connection, dropout time, response time, Interference behavior
Control elements	sensitivity adjustment
Control elements	Programming via menu driven remote control possible (Accessories ordered separately)

Electrical specifications

Operating voltage	U _B	12 ... 36 V DC , 12 ... 24 V AC
No-load supply current	I ₀	≤ 50 mA at 24 V DC
Power consumption	P ₀	≤ 1 W

Output

Switching type	NO/NC	
Signal output	relay	
Switching voltage	max. 48 V AC / 48 V DC	
Switching current	max. 0.5 A AC / 1 A DC	
Switching power	max. 24 W / 60 VA	
De-energized delay	t _{off}	0.2 ... 10 s adjustable (1 sec factory setting)

Directive conformity

Radio and telecommunication terminal equipment	
Directive 2014/53/EU	yes This device can be used in all countries within the European Union. Use in North America is not permitted. In other countries, all applicable national regulations must be observed.

Ambient conditions

Operating temperature	-20 ... 60 °C (-4 ... 140 °F)
Storage temperature	-30 ... 70 °C (-22 ... 158 °F)
Relative humidity	max. 90 % non-condensing

Mechanical specifications

Mounting height	max. 4000 mm
Degree of protection	IP54
Connection	plug-in screw terminals 4-pin , 5 m connecting cable included with delivery
Material	
Housing	ABS, anthracite
Mass	120 g
Dimensions	123 mm x 65 mm x 57 mm

Suitable series

Series	RMS
--------	-----

Operating principle

Microwave sensors are microwave scanners that use the principle of the Doppler radar. The most important requirement for microwave detection is that the object to be detected is moving.

The microwave sensors emit microwaves of a defined frequency in order to detect people and large objects moving at speeds between 100 mm/sec and 5 m/sec.

The microwaves emitted by the emitter are reflected back from the ground or other surfaces to the receiver. If there is no motion in the monitored zone, the emitted and reflected frequencies are identical. Nothing is detected. If people, animals or objects are moving in the monitored zone, the reflected frequency changes and therefore triggers a detection.

Microprocessor-controlled motion sensors based on the latest 24 GHz technology provide a high degree of reliability even under difficult operating conditions. The 24 GHz frequency, known as 'K-band,' is reserved by CETECOM for this application area worldwide.

Detection range

Typical applications

- Opening impulse sensor for automatic and industrial doors
- Monitoring approach areas to automatic doors and elevators
- Motion sensor for people and objects
- Impulse sensor for escalators
- Opening impulse sensor for entry doors

Detection area



Accessories

RMS Weather cap

All-weather hood for RMS series microwave sensors, for ceiling and wall installation

RMS Remote Control

Infrared remote control for RMS series and RAVE

RMS/RaDec Ceiling Kit wh

Ceiling mount kit for radar sensors in the RMS and RaDec Series

Other suitable accessories can be found at www.pepperl-fuchs.com

Installation instructions

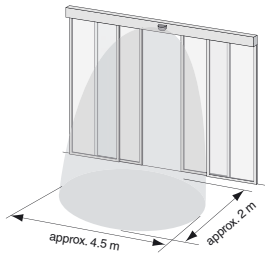

Installation height 2200 mm / angle of detection field 30°
Antenna position:

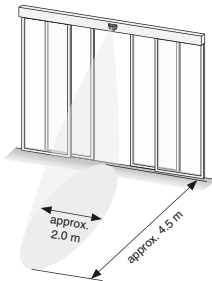
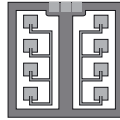

Installation height 2200 mm / angle of detection field 30°
Antenna position:

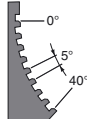
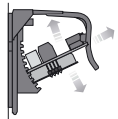
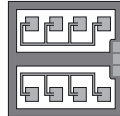

The detection field can be swivelled in 5 steps from 0 to 40°. The guide plate can be inserted on a slant.

Sensitivity settings

The sensitivity potentiometer can be used to adjust the size of the detection field.



Function display

LED green	Ready for operation
LED red	Relay active
LED green flashing	Command received
LED red flashing	Error
LED green/red flashing	Initialisation (for about 10 seconds after switching on)

Release date: 2017-11-28 09:40 Date of issue: 2017-11-28 194554_eng.xml

Refer to "General Notes Relating to Pepperl+Fuchs Product Information".

Pepperl+Fuchs Group
www.pepperl-fuchs.com

USA: +1 330 486 0001
fa-info@us.pepperl-fuchs.com

Germany: +49 621 776 4411
fa-info@de.pepperl-fuchs.com

Singapore: +65 6779 9091
fa-info@sg.pepperl-fuchs.com