

Product Data Sheet

8315100157

VWLG150KJLRS

AF172-00157 24V P/2

6800

ebmpapst

engineering a better life



AF172-00157 24V P/2 6800

INDEX

- 1 General 3**
- 2 Mechanics 3**
 - 2.1 General 3
 - 2.2 Connections 3
- 3 Operating Data 5**
 - 3.1 Electrical Interface - Input 5
 - 3.2 Electrical Operating Data 6
 - 3.3 Electrical Interface - Output 7
 - 3.4 Electrical Features 8
 - 3.5 Aerodynamics 9
 - 3.6 Sound Data 10
- 4 Environment 10**
 - 4.1 General 10
 - 4.2 Climatic Requirements 10
 - 4.3 EMC 10
- 5 Safety 12**
 - 5.1 Electrical Safety 12
 - 5.2 Approval Tests 12
- 6 Reliability 12**
 - 6.1 General 12

1 General

Fan type	Axial	
Rotating direction looking at rotor	Counterclockwise	
Airflow direction	Air outlet over struts	
Bearing system	Ball bearing	
Mounting position - shaft	Any	

2 Mechanics**2.1 General**

Width	150,0 mm	
Depth	51,0 mm	
Diameter	172,0 mm	
Mass	0,86 kg	
Housing material	Metal	
Impeller material	Plastic	
Max. torque when mounted across both mounting flanges	Wire outlet corner: 190 Ncm Remaining corners: 190 Ncm	
Screw size	ISO 4762 - M4 degreased, without an additional brace and without washer	

2.2 Connections

Electrical connection	Wires	
Lead wire length	L = 365 mm	
Tolerance	+ - 10,0 mm	
Tube length	S = 10 mm	
Tolerance	+ - 10 mm	

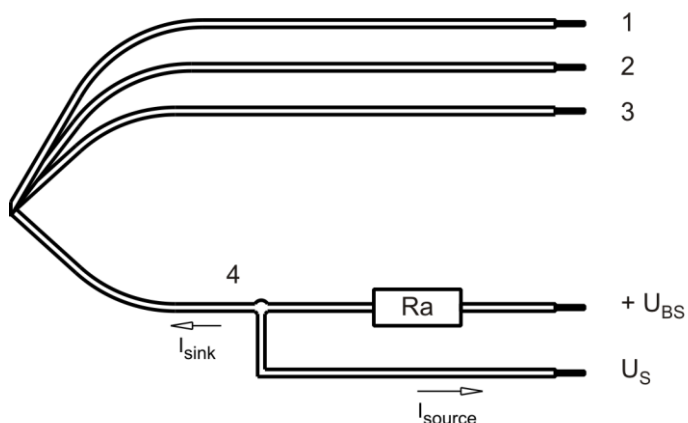

Wire	Color	Operation	Wire size	Insulation diameter
1	red	+ UB	AWG 20	2,05 mm
2	blue	- GND	AWG 20	2,05 mm
3	violet	PWM	AWG 22	1,3 mm
4	white	Tacho	AWG 22	1,3 mm

The auxiliaries shown on the schematic diagram (which are required for the intended use) are not part of our delivery.

3 Operating Data

3.1 Electrical Interface - Input

Control input	PWM
---------------	-----

Features

Input type	Open collector	
PWM - Frequency		typical: 2 kHz

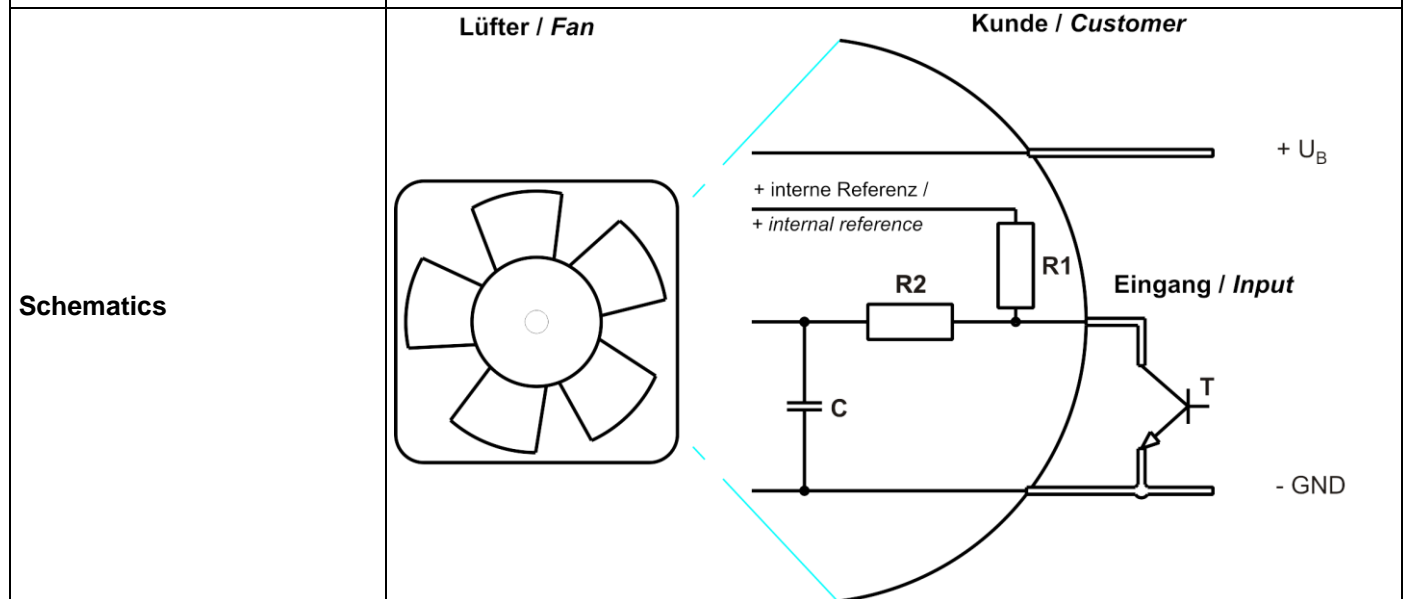
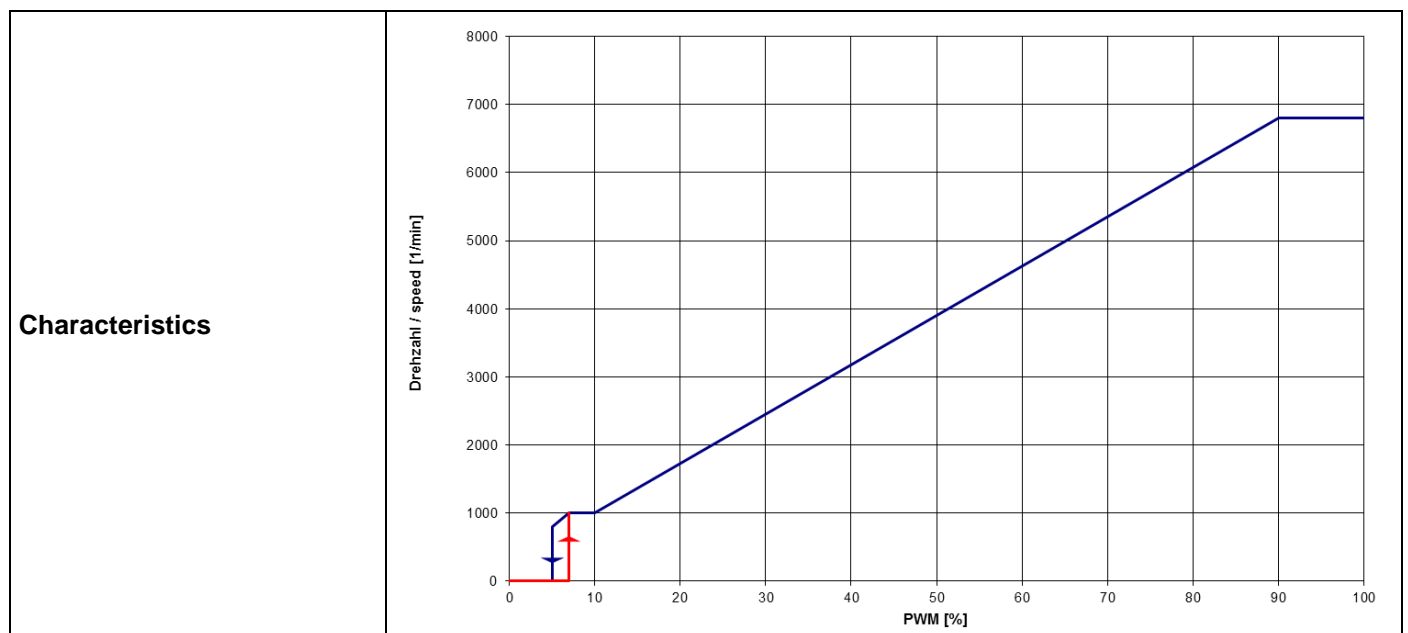

PWM input transistor requirements:
 $U_{CEmax.} \Rightarrow 12\text{ V}$; $I_{Sink\ max.} > 5\text{ mA}$; $U_{CEsat.} < 0,15\text{ V}$

Speed control:

By Puls width modulation (PWM) 0 ... 100%

Open collector in relation to signal-ground
 f = 2kHz +-20%

Information to the curve:

0% - <=7% PWM: 0 1/min (Fan off)
 7% PWM: 1.000 1/min (Start-up, comming from 0% PWM)
 7% - 10 % PWM: 1.000 1/min (corresp. to min fan speed)
 10% - 90% PWM: Linear increasing curve
 90% - 100% PWM: 8.300 1/min (corresp. to max fan speed)
 5% PWM: 800 1/min or 0 1/min (Fan turns off, comming from 100% PWM)

3.2 Electrical Operating Data

Measurement conditions: Normal air density = 1,2 kg/m3; Temperature 23°C +/- 3°C; Motor axis horizontal; warm-up time before measuring 5 minutes (unless otherwise specified). In the intake and outlet area should not be any solid obstruction within 0,5 m.

$\Delta p = 0$: corresp. to free air flow (see chapter aerodynamics)
 I: corresp. to arithm. mean current value

Name	Condition
PWM 0001	PWM: 100 %;

Features	Condition	Symbol	Values		
			16 V	24 V	30 V
Voltage range		U	16 V		30 V
Nominal voltage		U_N		24 V	
Power consumption	$\Delta p = 0$	P	31 W	58 W	58 W
Tolerance	PWM 0010		+/- 15 %	+/- 15 %	+/- 15 %
Current consumption	$\Delta p = 0$	I	1.900 mA	2.375 mA	1.900 mA
Tolerance	PWM 0010		+/- 15 %	+/- 15 %	+/- 15 %
Speed	$\Delta p = 0$	n	5.400 1/min	6.800 1/min	6.800 1/min
Tolerance	PWM 0010		+/- 10 %	+/- 10 %	+/- 10 %

3.3 Electrical Interface - Output

Tacho type	/2 (open collector)
------------	---------------------

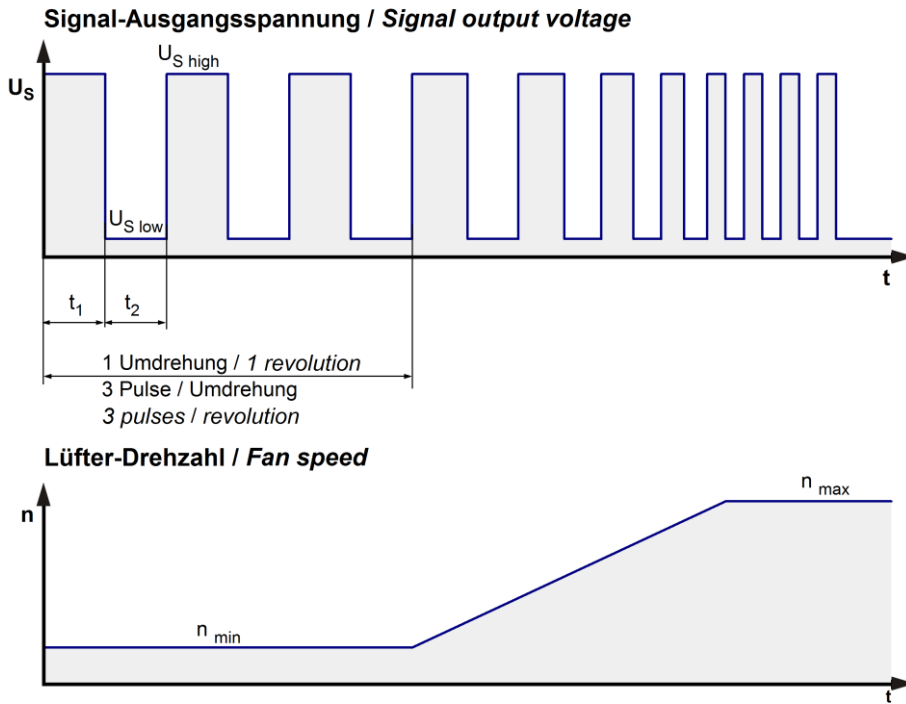

$$R_a = \frac{U_{BS} - U_{S\ low}}{I_{sink}}$$

Lüfter / Fan Kunde / Customer

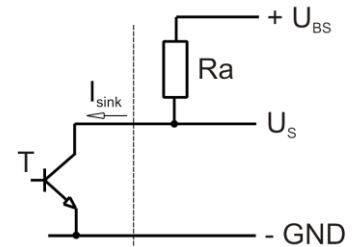

Features	Note	Values
Tacho operating voltage	U_{BS}	$\leq 60\text{ V}$
Tacho signal Low	$U_{S\ low}$	$\leq 0,4\text{ V}$
Tacho signal High	$U_{S\ high}$	
Maximum sink current	I_{sink}	$\leq 20\text{ mA}$
External resistor	External resistor R_a from U_{BS} to U_S required. All voltages measured to GND.	
Tacho frequency	$(3 \times n) / 60$	
Tacho isolated from motor	No	
Slew rate		$\Rightarrow 0,5\text{ V/us}$

n = revolutions per minute (1/min)

3.4 Electrical Features

Electronic function	Speed-Controlled	
Reversed polarity protection	Rectifying diode	
Max. residual current at U_N	$I_F \leq 5$	
Locked rotor protection	Auto restart	
Locked rotor current at U_N	I_{block}	
Clock signal at locked rotor Extended Downtime	t_3 / t_4 typical: 3 s / 10 s t_5 : 30 s after 5 start-up tests	
Internal fuse	Littelfuse NANO2 > Very Fast-Acting > 451/453 Series 6,3A / 125V (Art.No.: 045106.3MRL)	
Voltage control *)	Fan turns on at $U_B > 34$ V or < 74 V Fan turns off at $U_B < 32$ V or > 76 V	

*) This fan has an undervoltage and overvoltage control circuit integrated which turns the motor off if the voltage is out of range.

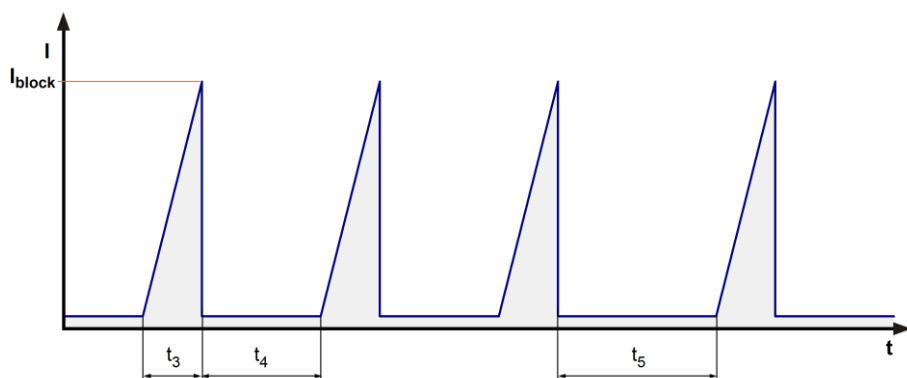

3.5 Aerodynamics

Measurement conditions: Measured with a double chamber intake rig acc. to DIN EN ISO 5801. Normal air density = 1,2 kg/m³; Temperature 23°C +/- 3°C; In the intake and outlet area should not be any solid obstruction within 0,5 m. Motor shaft horizontal.

The information is only valid under the specified test conditions and may be changed by the installation conditions. If there are deviations from the standard test conditions, the characteristic values must be checked under the installed conditions. Power consumption of the fan motor when operating at normal voltage is shown. Depending on the operating conditions of the application, the power input may be higher.

a.) Operation condition:

6.800 1/min at free air flow	PWM 100 %;		
------------------------------	------------	--	--

Max. free-air flow ($\Delta p = 0 / \dot{V} = \text{max.}$)	530 m ³ /h	
Max. static pressure ($\Delta p = \text{max.} / \dot{V} = 0$)	660 Pa	

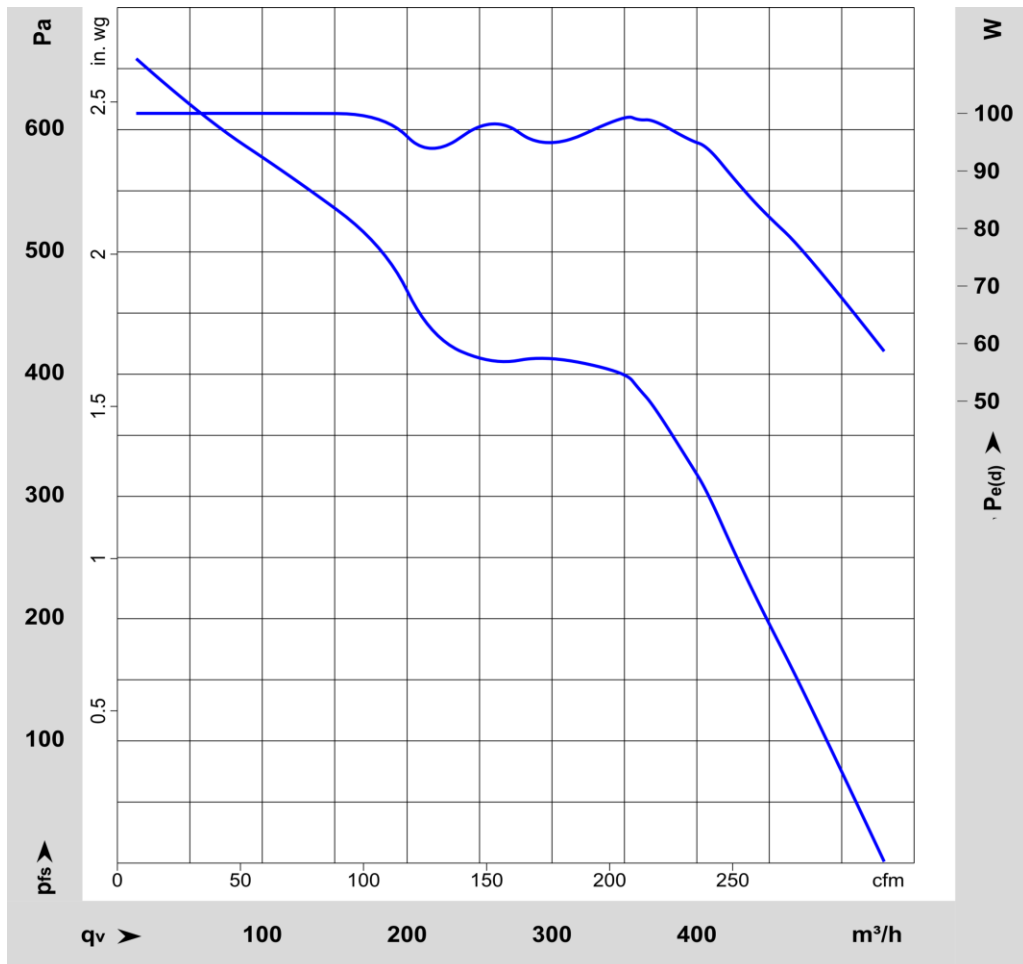

3.6 Sound Data

Measurement conditions: Sound pressure level: 1 meter distance between microphone and the air intake.
Sound power level: According to ISO 13347-3.
Measured in a semianechoic chamber with a background noise level of $L_p(A) < 5 \text{ dB(A)}$
For further measurement conditions see chapter aerodynamics.

a.) Operation condition:

6.800 1/min at free air flow	PWM 100 %;		
------------------------------	------------	--	--

Optimal operating point	425 m ³ /h @ 255 Pa	
Sound power level at the optimal operating point	7,7 bel(A)	
Sound pressure level at free air flow, measured in rubber bands	71 dB(A)	

4 Environment

4.1 General

Min. permitted ambient temperature TU min.	-20 °C	
Max. permitted ambient temperature TU max.	70 °C	
Min. permitted storage temperature TL min.	-40 °C	
Max. permitted storage temperature TL max.	80 °C	

4.2 Climatic Requirements

Humidity requirements	humid heat, constant; according to DIN EN 60068-2-78, 14 days	
Water exposure	None	
Dust requirements	None	
Salt fog requirements	None	

Permitted application area:

The product is intended for use in sheltered rooms with controlled temperature and controlled humidity. Directly exposure to water must be avoided.

Pollution degree 1 (according DIN EN 60664-1)

There is either no pollution or it occurs only dry, non-conductive pollution. The pollution has no negative impact.

Please require severity levels and specification parameters from the responsible development departments.

4.3 EMC

Kind	Conducted Emission; Voltage; 150 kHz-30 MHz (without PE)
According	DIN EN 55032:2016-02
Check accuracy / Limit	Class B
Result	Below limit Class B

Kind	Radiated Emission; 30 MHz - 1000 MHz (with PE)
Accordinging	DIN EN 55032:2016-02
Check accuracy / Limit	Class B
Result	Below limit Class B

Kind	Radiated Emission; 30 MHz - 1000 MHz (without PE)
Accordinging	DIN EN 55032:2016-02
Check accuracy / Limit	Class B
Result	Below limit Class B

Kind	Electrostatic Discharge Immunity Test
Accordinging	DIN EN 61000-4-2:2001-12
Check accuracy / Limit	Contact Discharge +/- 4 kV; Air Discharge +/- 8 kV
Result	A: The monitored function operates as designed during and after exposure to a disturbance.

Kind	Electromagnetic Field Immunity Test
Accordinging	DIN EN 61000-4-3:2006-12
Check accuracy / Limit	10 V/m; 80 - 1000 MHz; AM; m = 0,8; f = 1 kHz; 1%; t = 3 s
Result	A: The monitored function operates as designed during and after exposure to a disturbance.

Kind	Electrical Fast Transient / Burst Immunity Test
Accordinging	DIN EN 61000-4-4:2005-07
Check accuracy / Limit	+/- 2 kV on Power Lines; Coupling: POS, NEG, {PE}, ALL, 5 kHz and 100 kHz; 1 min
Result	B: The monitored function may deviate from designed performance to a specified level during exposure to a disturbance or revert to a fail safe mode or operation, but shall return to normal operation after the disturbance is removed.

Kind	Immunity to Conducted Disturbances, Induced by RF-Fields
Accordinging	DIN EN 61000-4-6:2001-12
Check accuracy / Limit	10 Vrms; 150 kHz - 80 MHz; AM; m = 0,8; f = 1 kHz; 1%; t = 3 s
Result	A: The monitored function operates as designed during and after exposure to a disturbance.

5 Safety

5.1 Electrical Safety

Dielectric strength DIN EN 62368 and DIN EN 60335 A.) Type test Measuring conditions: After 48h of storage at 95% R.H. and 25°C. No arcing or breakdown is allowed! All connections together to ground. B.) Routine test Measuring conditions: At indoor climate. No arcing or breakdown is allowed! All connections together to ground.	500 VAC / 1 Min. 850 VDC / 1 Sec.	
Isolation resistance Measuring conditions: After 48h of storage at 95% R.H. and 25°C measured with U=500 VDC for 1 min.	RI > 10 MOhm	
Clearance / creepage distance	0,5 mm / 1,2 mm	
Protection class	III	

5.2 Approval Tests

CE	EC Declaration of Conformity	Yes
EAC	Eurasian Conformity	Yes
UL	Underwriters Laboratories	Yes / UL507, Electric Fans E38324
VDE	Association for Electrical, Electronic and Information Technologies	Yes / Approval acc. to EN 62368 - Audio/video, information and communication technology equipment
CSA	Canadian Standards Association	Yes / CSA audited by UL according to C22.2 No. 113 Fans and Ventilators
CCC	China Compulsory Certification	Not applicable

6 Reliability

6.1 General

Life expectancy L10 at TU = 40 °C	84.000 h	
Life expectancy L10 at TU max.	42.000 h	
Life expectancy L10 acc. to IPC 9591 at TU = 40 °C	141.750 h	

Copies of this document, and their use, are the property of the customer thereof. The customer shall be responsible for the return of the original and for the return of all rights reserved in the event of the grant of a patent or the registration of a utility model or design.

Sperrung nach DIN ISO 9001 (Anforderungen an Produktion) oder DIN ISO 14001 (Umweltmanagement)

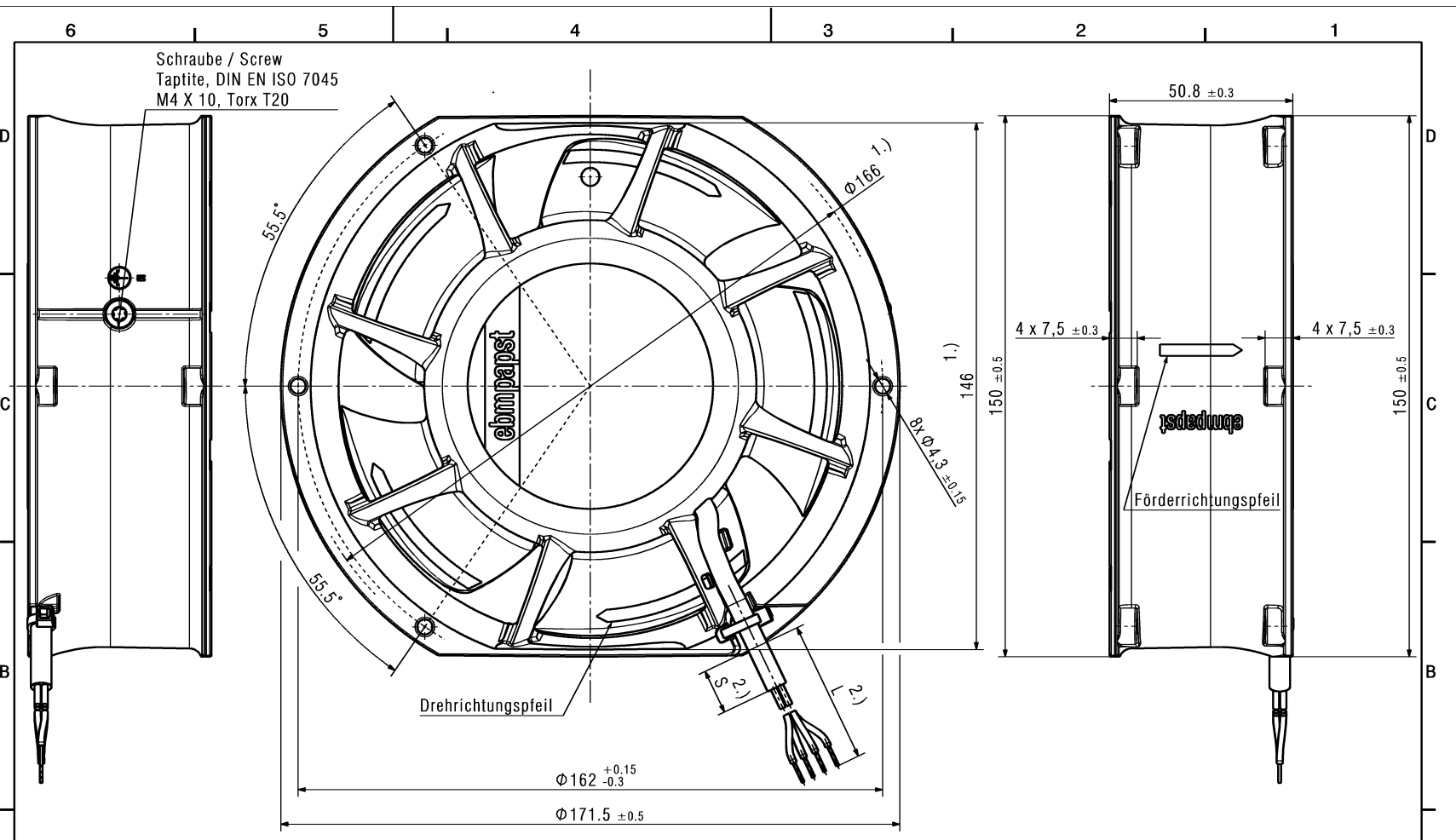

- A
- 1.) Maße aus Montageausschnitt
 - 2.) Anzahl und Länge der Litzen/Schlauch siehe Produktspezifikation
 - Axialspiel der Kugellager mit Feder spielfrei verspannt
- 1.) measures of mounting cut out
- 2.) length and number of wires/tube see product specification
- ball bearing without clearance by a pre-load spring

Dokument-Status / Document-State 		CATIA-Version/ CATIA-Version 801510009 CPM000	CAD-Umgebung/ CAD-Environment	Werkstoff / Material:	Volumen / Volume (cm³):	
Aend.-Nr. / Change-No.:		3D-Referenzmodell / 3D-Reference Model:		Titel / Title:		
Tolerierung / Tolerances:		Datum	Name	Zsg.-Nr. / Drawing No:		
Allgmeintoleranzen / Gen. Tolerances:		Bearb. / Drawn	Freig. / Released	Ers.-f. Zsg. / Replaces:		
ebmpapst ebm-papst St. Georgen GmbH & Co KG			Dokumenttyp / Type of Document	Teil/Lookument (Blatt/Page)	Index / Index:	
		Format / Size:	Messtab/Scale			