

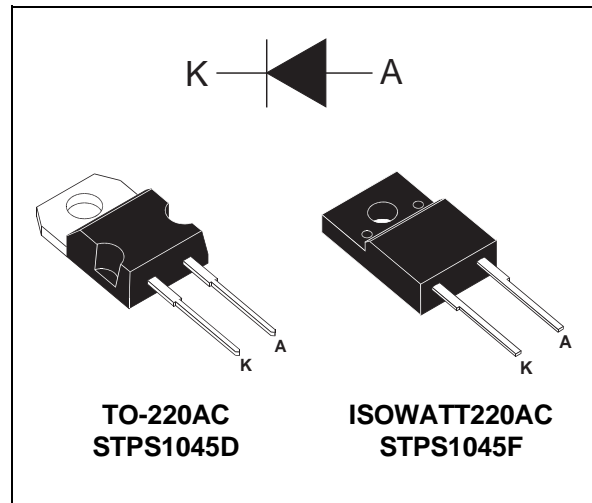
## POWER SCHOTTKY RECTIFIER

### MAIN PRODUCT CHARACTERISTICS

$I_{F(AV)}$	<b>10 A</b>
$V_{RRM}$	<b>45 V</b>
$V_F$	<b>0.57 V</b>

### FEATURES AND BENEFITS

- VERY SMALL CONDUCTION LOSSES
- NEGLIGIBLE SWITCHING LOSSES
- EXTREMELY FAST SWITCHING
- LOW FORWARD VOLTAGE DROP
- INSULATED PACKAGE: ISOWATT220AC  
Insulating voltage = 2000V DC  
Capacitance = 12pF



### DESCRIPTION

Single chip Schottky rectifier suited for Switch Mode Power Supply and high frequency DC to DC converters.

This device is intended for use in low voltage, high frequency inverters, free wheeling and polarity protection applications.

### ABSOLUTE RATINGS (limiting values)

Symbol	Parameter		Value	Unit	
$V_{RRM}$	Repetitive peak reverse voltage		45	V	
$I_{F(RMS)}$	RMS forward current		30	A	
$I_{F(AV)}$	Average forward current $\delta = 0.5$	TO-220AC	$T_c = 150^\circ\text{C}$	10	A
		ISOWATT220AC	$T_c = 145^\circ\text{C}$		
$I_{FSM}$	Surge non repetitive forward current		$t_p = 10 \text{ ms}$ Sinusoidal	180	A
$I_{RRM}$	Repetitive peak reverse current		$t_p = 2 \mu\text{s}$ $F = 1\text{KHz}$	1	A
$T_{stg}$	Storage temperature range		- 65 to + 175	$^\circ\text{C}$	
$T_j$	Maximum junction temperature		175	$^\circ\text{C}$	
$dV/dt$	Critical rate of rise of reverse voltage		10000	$\text{V}/\mu\text{s}$	

# STPS1045D/F

## THERMAL RESISTANCES

Symbol	Parameter		Value	Unit
$R_{th(j-c)}$	Junction to case	TO-220AC	2.2	°C/W
		ISOWATT220AC	4.5	

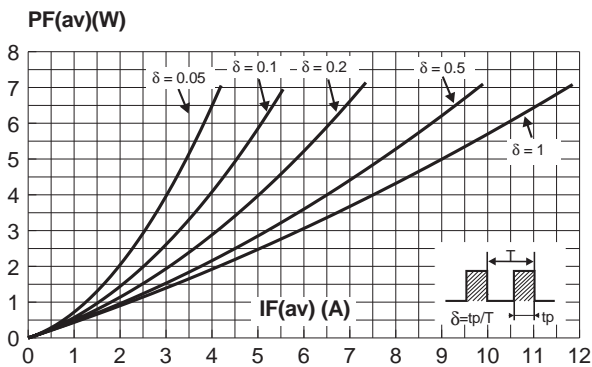
## STATIC ELECTRICAL CHARACTERISTICS

Symbol	Parameter	Tests Conditions		Min.	Typ.	Max.	Unit
$I_R^*$	Reverse leakage current	$T_j = 25^\circ\text{C}$	$V_R = V_{RRM}$			100	$\mu\text{A}$
		$T_j = 125^\circ\text{C}$				15	mA
$V_F^{**}$	Forward voltage drop	$T_j = 25^\circ\text{C}$	$I_F = 15\text{ A}$			0.84	V
		$T_j = 125^\circ\text{C}$	$I_F = 15\text{ A}$			0.72	
		$T_j = 125^\circ\text{C}$	$I_F = 7.5\text{ A}$			0.57	

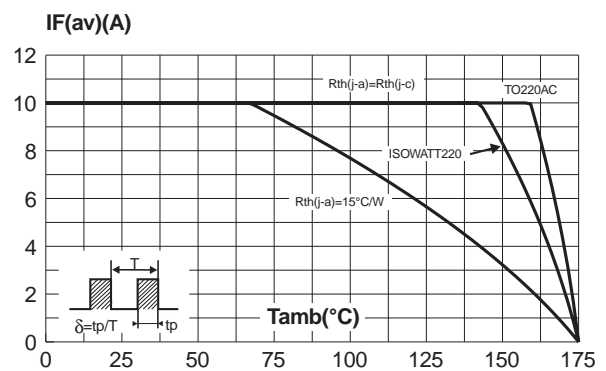
Pulse test : \*  $t_p = 5\text{ ms}, \delta < 2\%$   
 \*\*  $t_p = 380\text{ }\mu\text{s}, \delta < 2\%$

To evaluate the conduction losses use the following equation :  
 $P = 0.42 \times I_{F(AV)} + 0.015 I_{F(RMS)}^2$

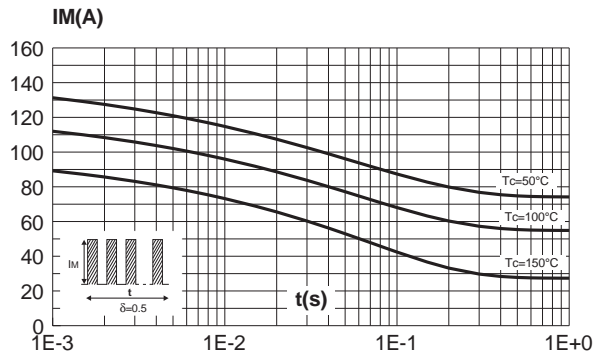
**Fig. 1:** Average forward power dissipation versus average forward current.



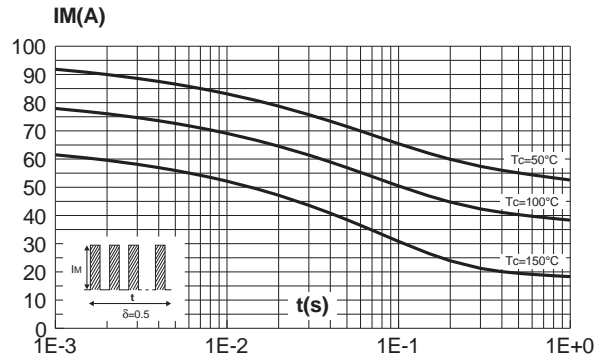
**Fig. 2:** Average current versus ambient temperature ( $\delta : 0.5$ ).



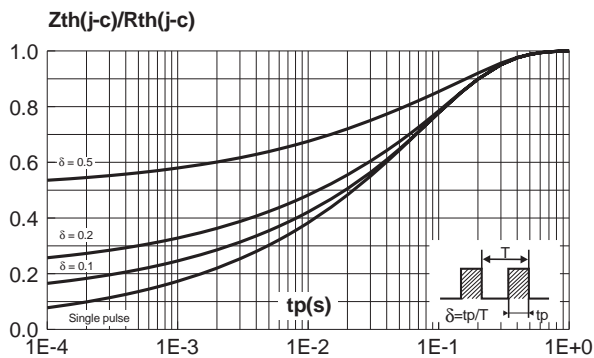
**Fig. 3-1:** Non repetitive surge peak forward current versus overload duration (maximum values) (TO-220AC).



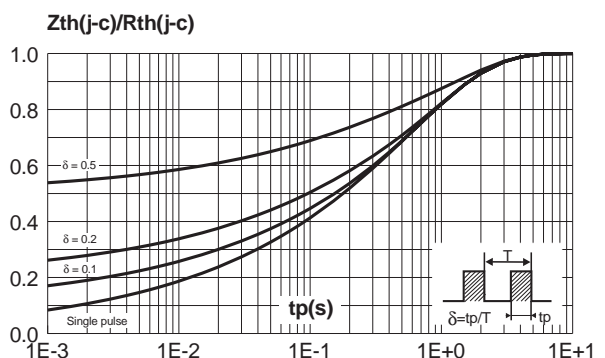
**Fig. 3-2:** Non repetitive surge peak forward current versus overload duration (maximum values) (ISOWATT220AC).



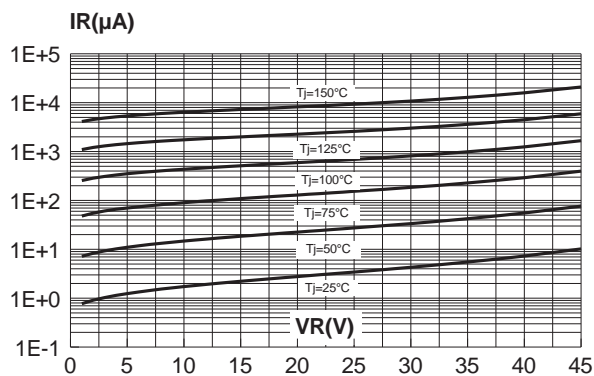
**Fig. 4-1:** Relative variation of thermal transient impedance junction to case versus pulse duration (TO-220AC).



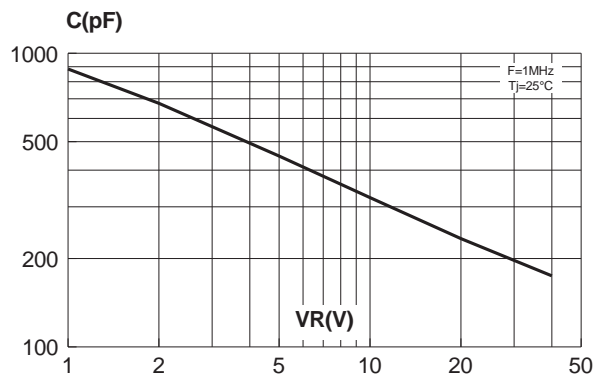
**Fig. 4-2:** Relative variation of thermal transient impedance junction to case versus pulse duration (ISOWATT220AC).



**Fig. 5:** Reverse leakage current versus reverse voltage applied (typical values).

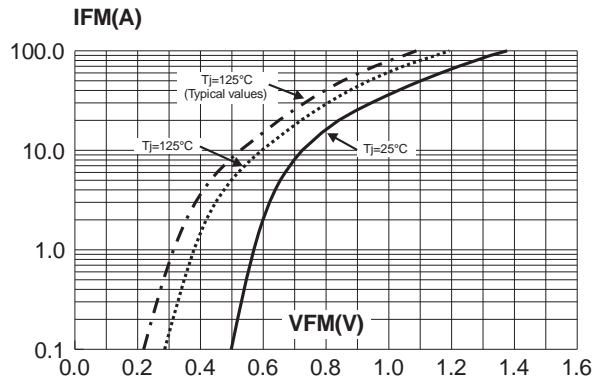


**Fig. 6:** Junction capacitance versus reverse voltage applied (typical values).



# STPS1045D/F

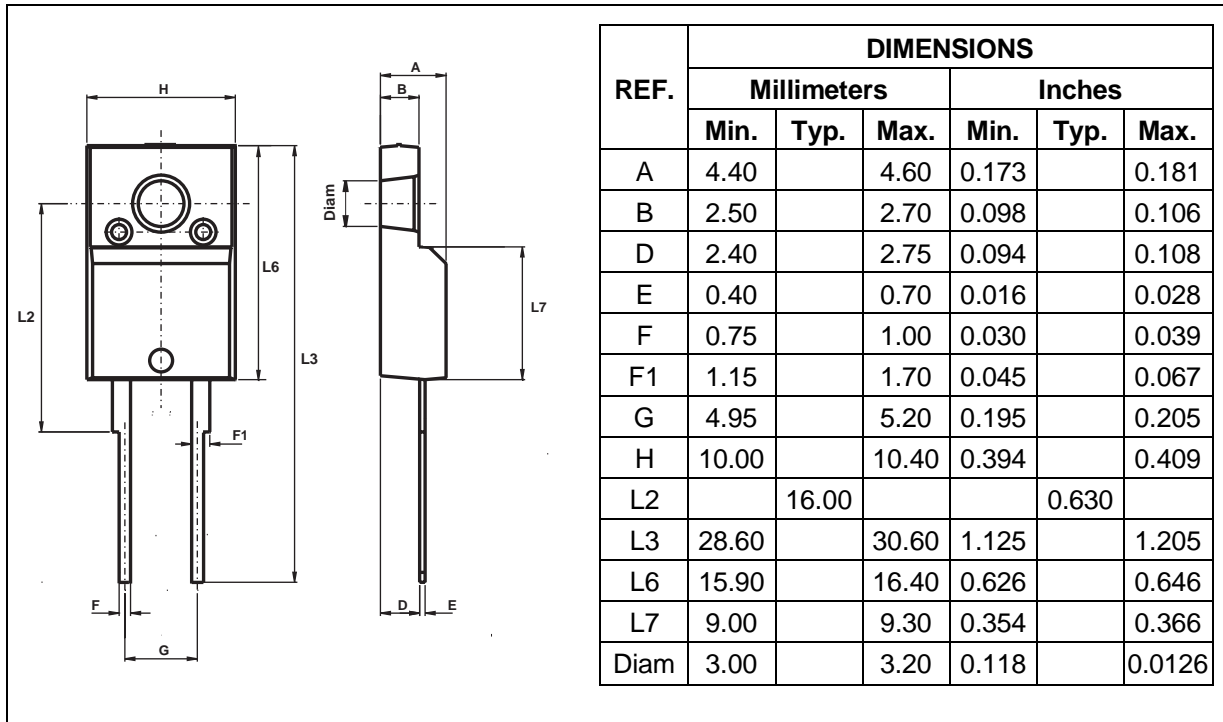
**Fig. 7:** Forward voltage drop versus forward current (maximum values).



## PACKAGE MECHANICAL DATA TO-220AC

REF.	DIMENSIONS			
	Millimeters		Inches	
	Min.	Max.	Min.	Max.
A	4.40	4.60	0.173	0.181
C	1.23	1.32	0.048	0.051
D	2.40	2.72	0.094	0.107
E	0.49	0.70	0.019	0.027
F	0.61	0.88	0.024	0.034
F1	1.14	1.70	0.044	0.066
G	4.95	5.15	0.194	0.202
H2	10.00	10.40	0.393	0.409
L2	16.40 typ.		0.645 typ.	
L4	13.00	14.00	0.511	0.551
L5	2.65	2.95	0.104	0.116
L6	15.25	15.75	0.600	0.620
L7	6.20	6.60	0.244	0.259
L9	3.50	3.93	0.137	0.154
M	2.6 typ.		0.102 typ.	
Diam. I	3.75	3.85	0.147	0.151

**PACKAGE MECHANICAL DATA**  
ISOWATT220AC



Information furnished is believed to be accurate and reliable. However, STMicroelectronics assumes no responsibility for the consequences of use of such information nor for any infringement of patents or other rights of third parties which may result from its use. No license is granted by implication or otherwise under any patent or patent rights of STMicroelectronics. Specifications mentioned in this publication are subject to change without notice. This publication supersedes and replaces all information previously supplied. STMicroelectronics products are not authorized for use as critical components in life support devices or systems without express written approval of STMicroelectronics.

The ST logo is a registered trademark of STMicroelectronics

© 1999 STMicroelectronics - Printed in Italy - All rights reserved.

STMicroelectronics GROUP OF COMPANIES

Australia - Brazil - China - Finland - France - Germany - Hong Kong - India - Italy - Japan - Malaysia  
Malta - Morocco - Singapore - Spain - Sweden - Switzerland - United Kingdom - U.S.A.

<http://www.st.com>