

Features

- Compact 10.35 x 7.5mm SMD package
- Low profile (2.5mm)
- 3kVDC/1min isolation
- Low EMI emissions
- Ultra-wide temperature range -40°C to +125°C
- Fully automated, high-reliability design
- Semi-regulated 5V output

Regulated Converters



RxxC05TExxS

0.5 Watt
16-Pin SOIC
Single Output

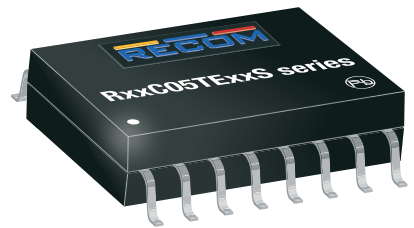

IEC/EN62368-1 pending

Description

The R05C05TE05S is a low cost, low profile, 0.5W SMD isolated DC/DC single output converter with 4.5-5.5V input range and a semi-regulated 5V output. There is no minimum load requirement which is ideal for applications which switch into very light load operation modes. The device is also able to deliver a 600mW for applications requiring additional power for short peak operation modes. Standard isolation is 3kVDC/1min, and the operating temperature is from -40°C up to +125°C with derating. The fully-automated design which is equipped with short-circuit, over-current, and over-temperature protection ensures the highest reliability in applications such as communication, current sensing, and COM port isolation.

Selection Guide

Part Number	Input Voltage Range [VDC]	Output Voltage [VDC]	Output Power [W]	Efficiency typ. ⁽¹⁾ [%]
R05C05TE05S	4.5-5.5	5	0.5	53

Notes:

Note1: nom. V_{IN} = 5VDC, V_{OUT} = 5VDC, full load

Model Numbering



Notes:

Note2: add suffix “-R” for standard tape and reel packaging

add suffix “-CT” for bag packaging for more details refer to **“PACKAGING INFORMATION”**

Specifications (measured @ Ta= 25°C, nom. Vin, full load and after warm-up unless otherwise stated)

ABSOLUTE MAXIMUM RATINGS ⁽³⁾				
Parameter	Condition	Min.	Typ.	Max.
Absolute Maximum Voltage	+V _{IN} to -V _{IN}	-0.3VDC		6VDC
	+V _{IN} to -V _{IN} or SGND _{IN}	-0.3VDC		6VDC
	+V _{OUT} to -V _{OUT} or SGND _{OUT}	-0.3VDC		6VDC
Operating IC Junction Temperature (T _J)				+150°C
Lead Temperature				+260°C
Storage Temperature (T _{STO})		-65°C		+150°C

Notes:

Note3: Stresses beyond those listed under absolute maximum ratings can cause permanent damage to the device. (Values are at non-operating)

Specifications (measured @ Ta= 25°C, nom. Vin, full load and after warm-up unless otherwise stated)

BASIC CHARACTERISTICS

Parameter	Condition	Min.	Typ.	Max.
Input Voltage Range		4.5VDC	5VDC	5.5VDC
Under Voltage Lockout (UVLO)	DC-DC ON DC-DC OFF		3.28VDC 2.88VDC	
Under Voltage Lockout Hysteresis			190mV	
Input Current Range	P _{OUT} = 0.5W P _{OUT} = 0.6W		240mA 255mA	
Quiescent Current			7mA	
Minimum Load		0%		
Internal Operating Frequency			30MHz	
Output Ripple Voltage			50mVp-p	100mVp-p

Typical Application Circuit

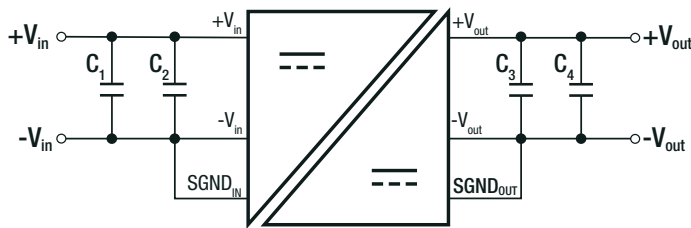

Input and Output Capacitors*

C ₁	C ₂	C ₃	C ₄
10µF	0.1µF	10µF	0.1µF

*these capacitors are mandatory for stable operation

Efficiency vs. Load

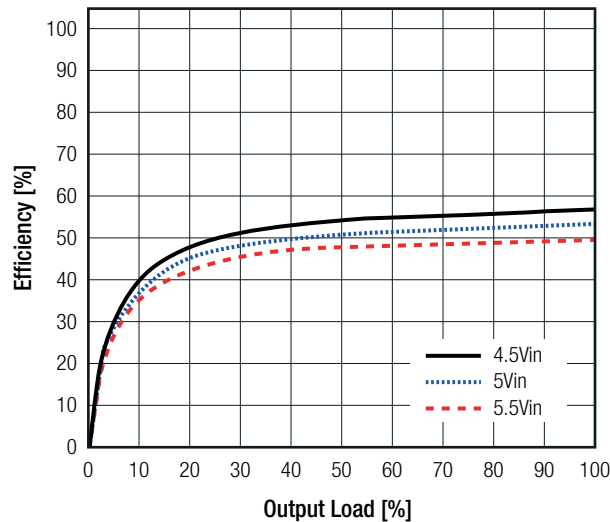

REGULATION

Parameter	Condition	Min.	Typ.	Max.
Output Voltage Accuracy	V _{IN} = 4.5-5.5VDC, load= 0A		±1.5%	
Line Regulation	V _{IN} = 4.5-5.5VDC, load= 0.12A		±0.5%	
Load Regulation	0% - 100% load		1.0%	

Specifications (measured @ Ta= 25°C, nom. Vin, full load and after warm-up unless otherwise stated)

PROTECTIONS

Parameter	Condition	Values
Short Circuit Protection (SCP)		continuous , hiccup mode
Over Current Protection		220mA, hiccup mode
Over Temperature Protection		automatic restart after cool down
Thermal Shutdown	IC junction temperature hysteresis	+160°C +20°C
Isolation Voltage	tested for 1second rated for 1 minute	3.6kVDC 3kVDC
Isolation Resistance	V _{ISO} = 500VDC, 25°C	50Ω typ.
Isolation Capacitance		7pF typ.
External Clearance		>8mm
External Creepage		>8mm

ENVIRONMENTAL

Parameter	Condition	Value
Operating Temperature Range	@ natural convection 0.1m/s with derating	-40°C to +125°C
ESD	human-body model (HBM), ANSI/ESDA/JEDEC JS-001	±6.0kV
	charged-device model (CDM), JEDEC JESD22-C101	±2.0kV
Moisture Sensitive Level	MSL peak temp. ⁽⁵⁾	Level 3, 260°C, 168hrs
Thermal Impedance ⁽⁶⁾	junction to T _{AMB}	63.8K/W
	junction to case (top)	21.4K/W
	junction to case (bottom)	37.2K/W
	junction to board	38.5K/W

Notes:

Note5: The Moisture Sensitivity Level rating according to the JEDEC industry standard classifications, and peak solder temperature

Note6: Tested with 54.0 x 85.6mm 2 layer PCB with 105µm copper

Peak Load Capability

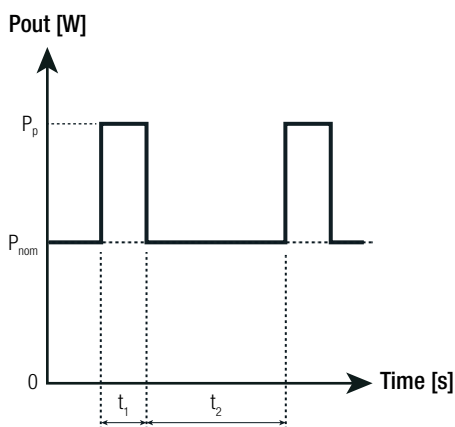

- P_{nom} = nom. output power (0.5W) [W]
- P_p = peak output power (≤0.6W) [W]
- t₁ = peak time set (60s max.) [s]
- t₂ = recovery time (min. 3 x t₁) [s]

Thermal Derating ⁽⁶⁾

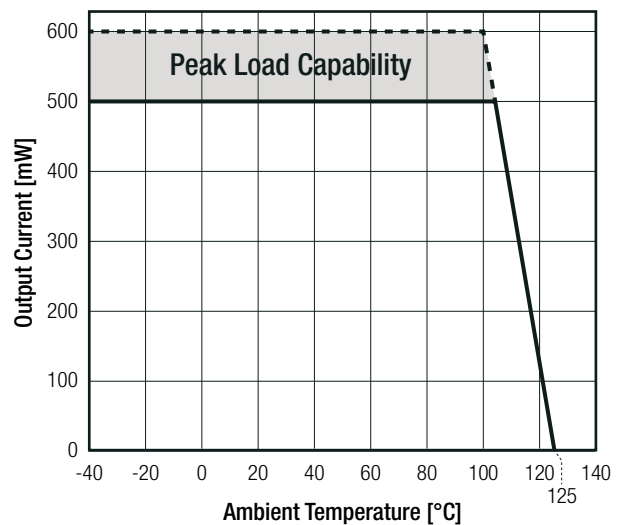

Specifications (measured @ Ta= 25°C, nom. Vin, full load and after warm-up unless otherwise stated)

SAFETY AND CERTIFICATIONS

Certificate Type (Safety)	Report Number	Standard
Information Technology Equipment, General Requirements for Safety (CB Scheme)	pending	IEC62368-1:2018, 3rd Edition
Information Technology Equipment, General Requirements for Safety		EN62368-1:2020 + A11:2020
RoHS2		RoHS 2011/65/EU + AM2015/863

DIMENSION AND PHYSICAL CHARACTERISTICS

Parameter	Type	Value
Dimension (LxWxH)		10.35 x 7.5 x 2.50mm
Weight		0.1g typ.

Dimension Drawing (mm)

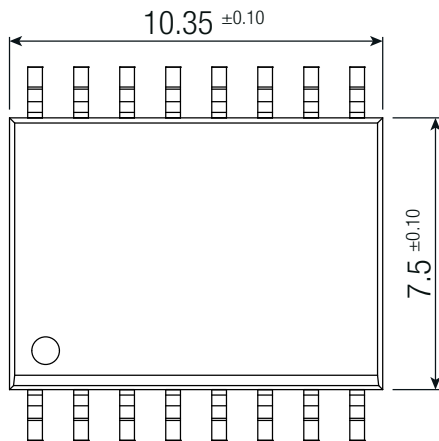
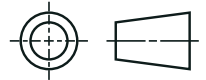

Pin Information

Pad #	Function
1,2	-VIN
3,4	+VIN
5,6,7,8	SGND _{IN}
9,11,12	SGND _{OUT}
10	TM
13,14	+V _{OUT}
15,16	-V _{OUT}

Tolerances: x.x= ±0.1mm
x.xx= ±0.05mm

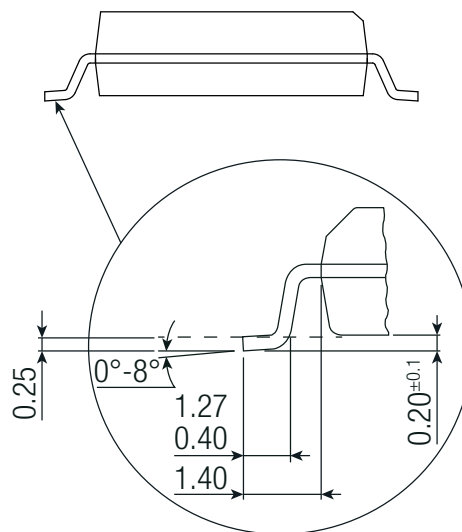
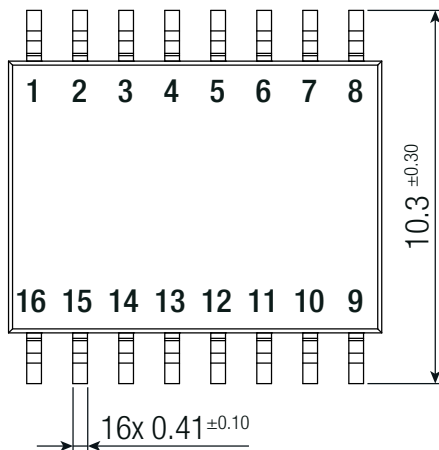
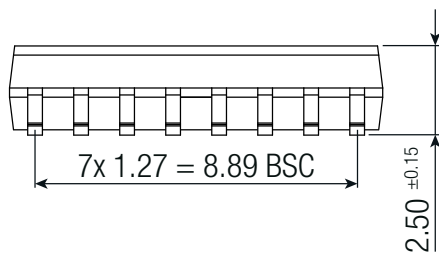

Specifications (measured @ Ta= 25°C, nom. Vin, full load and after warm-up unless otherwise stated)

Footprint Details

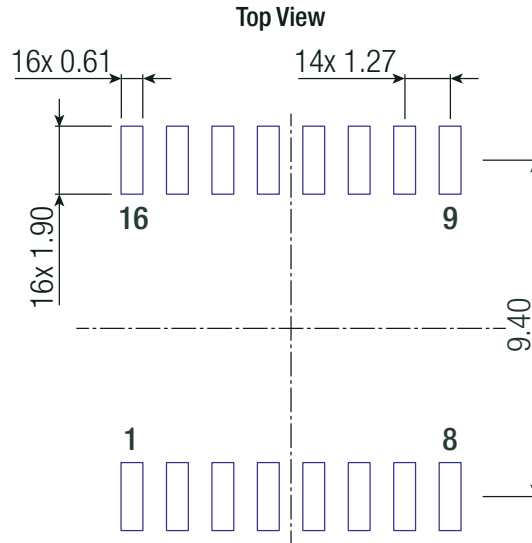

PACKAGING INFORMATION

Parameter	Type	Value
Packaging Dimension (LxWxH)	reel (diameter + width)	Ø330.0 + 24.8mm height
	tape and reel (carton)	355.6 x 355.6 x 50.8mm
	moisture barrier bag ("-CT")	100.0 x 100.0 x 30mm
Tape Width		24mm
Packaging Quantity	tape and reel	500pcs
	moisture barrier bag ("-CT")	10pcs
Storage Temperature Range		-65°C to +150°C

The product information and specifications may be subject to changes even without prior written notice. The product has been designed for various applications; its suitability lies in the responsibility of each customer. The products are not authorized for use in safety-critical applications without RECOM's explicit written consent. A safety-critical application is an application where a failure may reasonably be expected to endanger or cause loss of life, inflict bodily harm or damage property. The applicant shall indemnify and hold harmless RECOM, its affiliated companies and its representatives against any damage claims in connection with the unauthorized use of RECOM products in such safety-critical applications.