

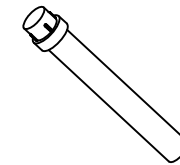

Part No.	X = Body Length
PLP1-100-F	0.100 (2.5mm)
PLP1-125-F	0.125 (3.2mm)
PLP1-188-F	0.188 (4.8mm)
PLP1-250-F	0.250 (6.4mm)
PLP1-313-F	0.313 (7.9mm)
PLP1-350-F	0.350 (8.9mm)
PLP1-375-F	0.375 (9.5mm)
PLP1-500-F	0.500 (12.7mm)
PLP1-625-F	0.625 (15.9mm)
PLP1-750-F	0.750 (19.0mm)
PLP1-830-F	0.830 (21.1mm)
PLP1-3MM-F	3mm (0.118")
PLP1-4MM-F	4mm (0.157")
PLP1-5MM-F	5mm (0.197")
PLP1-6MM-F	6mm (0.236")
PLP1-7MM-F	7mm (0.276")
PLP1-8MM-F	8mm (0.315")
PLP1-9MM-F	9mm (0.354")
PLP1-10MM-F	10mm (0.394")

REV.	DESCRIPTION	DATE	APPROVED
L	Updated General Specifications Note 1.	10/01/12	T. Y.
M	Added Panel Thickness.	05/01/15	J. C.
N	Added .188" and .313" Lengths To Offering List.	05/27/15	J. C.
P	Added Metric Lengths To Offering List.	07/15/15	J. C.
R	Added Color Options, Sheet #2.	02/02/16	J. C.

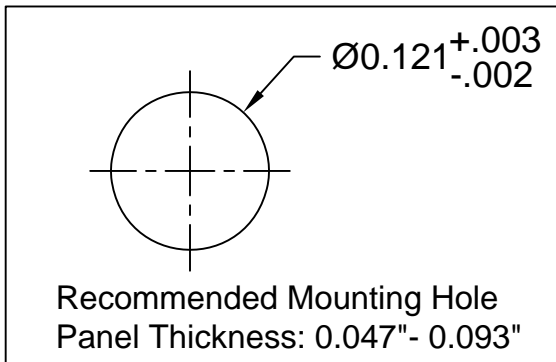
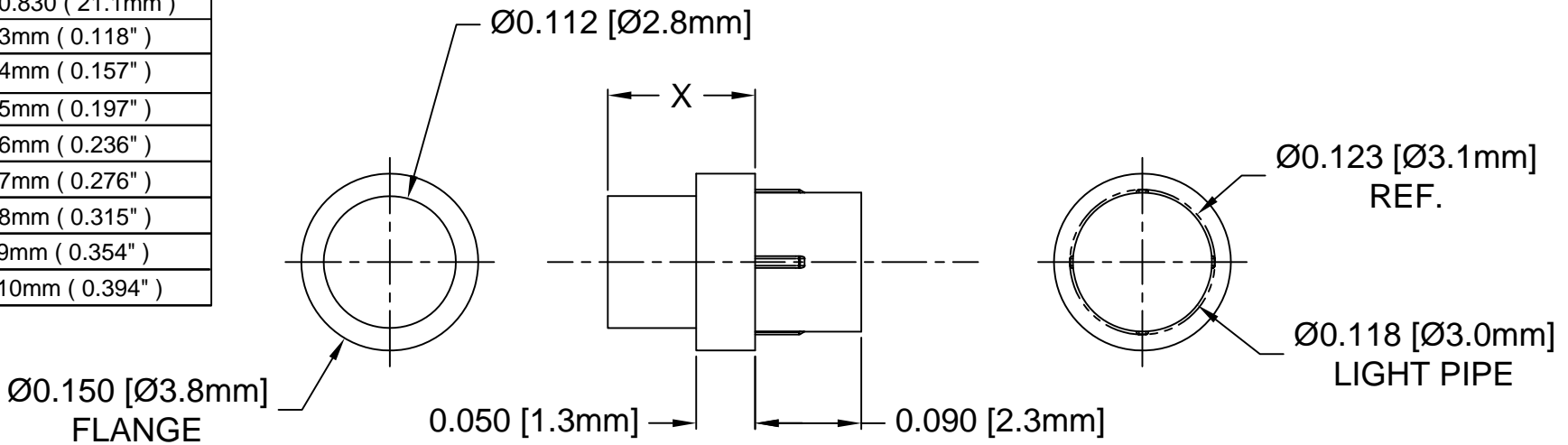

2. MATERIAL: POLYCARBONATE, 94V-0, CLEAR.

1. GENERAL SPECIFICATIONS: BIVAR MOLDED COMPONENT SPECIFICATION BV00-E101 and BSMC-1001.

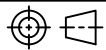
STANDARD TOLERANCE (UNLESS OTHERWISE SPECIFIED)		 4 THOMAS, IRVINE, CA. 92618 TEL: (949) 951-8808 FAX: (949) 951-3974	
DECIMALS	ANGULAR		
.X ± .1	X° ± 1°	 TITLE: PRESS-FIT, PANEL MOUNT, LIGHT PIPE, FLAT TOP	
.XX ± .01			
.XXX ± .005			
DESIGNED: Michael Chen	DATE: 01/16/02	PART NO: PLP1-XXX-F	REVISION: R
CHECKED: E. M. Muldoon	DATE: 04/26/02	CAGE CODE : 32559	SHEET # 1 OF 2
CAD GENERATED DOCUMENT. DO NOT MEASURE DRAWING.			

OTHER AVAILABLE COLORS

* SEE TABLE FOR ORDERING INFORMATION

REV.	DESCRIPTION	DATE	APPROVED
	SEE SHEET #1		

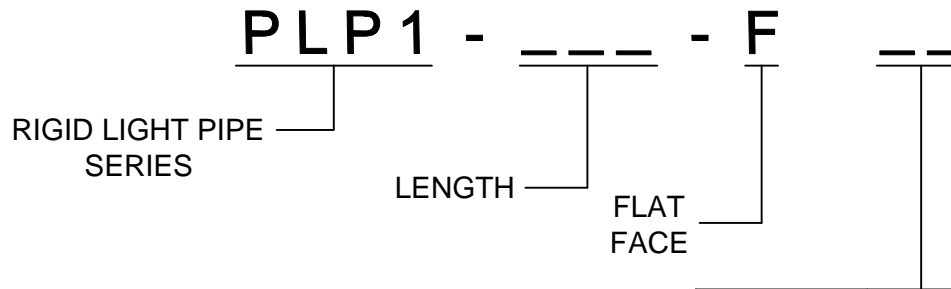

COLOR	Order Code
BLUE	BE
BLACK	BK
GREEN	GN
GRAY	GY
RED	RD
YELLOW	YW

NOTE: LEAVE ORDER CODE BLANK IF NO COLOR IS DESIRED.

3. PARTS ARE DYED TO COLOR UPON REQUEST.

STANDARD TOLERANCE (UNLESS OTHERWISE SPECIFIED) DECIMALS ANGULAR		BIVAR [®] 4 THOMAS, IRVINE, CA. 92618 TEL: (949) 951-8808 FAX: (949) 951-3974	
			
DESIGNED: K. Aukshunas	DATE: 01/25/16	TITLE: PRESS-FIT, PANEL MOUNT, LIGHT PIPE, FLAT TOP	REVISION: R
CHECKED: J. Chiang	DATE: 01/25/16	PART NO: PLP1-XXX-F	CAGE CODE : 32559 SHEET # 2 OF 2
<small>CAD GENERATED DOCUMENT. DO NOT MEASURE DRAWING.</small>			