

RG 1-phase solid state relays with integrated monitoring



RGS..M

RGC..M

Description

The **RG..M** solid state relays incorporate monitoring functions for fast failure detection on top of the switching capability in a slim 17.5 mm platform (up to 30 AAC). Timely detection for mains loss, load loss, SSR open and short circuit, SSR internal fault and supply out range are all possible with the **RG..M** series. This range of solid state relays is equipped with an Alarm LED for visual indication of fault presence as well as an alarm transistor output for remote signalling.

The **RG..M** solid state relays are available either with integrated heatsink, **RGC..M** and without heatsink, **RGS..M**. Ratings go up to 660 VAC, 65 AAC for **RGC..M** and 90 AAC for **RGS..M**. The **RG..M** has to be supplied with a 24 VDC voltage and is controlled with a DC voltage between 4 and 32 VDC.

Specifications are noted at 25°C unless otherwise stated.

Benefits

- **Cost savings by timely detection of failures.** Integrated monitoring for load or solid state relay malfunction provides immediate feedback to the PLC for a timely reaction to prevent non-conforming material.
- **Reduced efforts in troubleshooting.** An Alarm LED on the front façade of the solid state relay is available to indicate the problematic zone.
- **Increased machine uptime.** Integrated overvoltage protection prevents the solid state relay from breaking down due to uncontrolled transients.
- **Long lifetime.** Wire bonding technology reduces thermal and mechanical stresses of the output chips allowing a larger number of operational cycles compared to other assembly technologies.
- **Fast installation and wiring.** The **RG..M** is equipped with pluggable spring terminals for fast wiring of control connections.
- **Panel space savings.** Adopts the RG slimline compact platform with a minimum product width of 17.5 mm for ratings up to 30 AAC @ 40°C.
- **Accommodates UL508A requirements for Industrial Control Panels.** **RGC..M** is certified as a listed product and additionally all **RG..M** models carry a 100 kArms Short Circuit Current Rating.

Applications

Typical applications for the **RG..M** include plastic processing machinery, packaging machines, semiconductor machines, wood manufacturing machinery and drying equipment.

The **RG..M** is the ideal solution where it is crucial to avoid re-work of processed material that may occur in case a malfunction is not detected in a timely manner. This is especially applicable in processes where a deviation in temperature control needs to be detected immediately and in temperature control processes that do not have an accurate temperature feedback as is very typical with applications using Infrared heaters.

Main features

- 1-phase zero cross solid state relay with integrated monitoring for solid state relay or load malfunction
- Normally open or normally closed alarm transistor output for remote signaling of an alarm condition
- Ratings up to 90 AAC, 660 VAC with a control voltage range of 4-32 VDC

Order code

 RGC1A D EM

Enter the code entering the corresponding option instead of

Code	Option	Description	Comments
R	-		
G	-	Solid State Relay (RG) with integrated heatsink	
C	-		
1	-	Number of poles	
A	-	Switching mode: zero cross	
<input type="checkbox"/>	23	Rated voltage: 230 VAC (42-265 VAC) 50/60 Hz	
	60	Rated voltage: 600 VAC (150-660 VAC) 50/60 Hz	
D	-	Control voltage: 4-32 VDC	
<input type="checkbox"/>	15	Rated current: 20 AAC (525 A ² s)	17.5 mm wide, low depth
	25	Rated current: 25 AAC (1800 A ² s)	17.5 mm wide, low depth
	30	Rated current: 30 AAC (1800 A ² s)	22.5 mm wide
	31	Rated current: 30 AAC (6600 A ² s)	17.5 mm wide, low depth
	42	Rated current: 43 AAC (18000 A ² s)	35 mm wide
	62	Rated current: 65 AAC (18000 A ² s)	70 mm wide
<input type="checkbox"/>	K	Screw connection for power terminals	
	G	Box clamp connection for power terminals	
E	-	Connection configuration	
M	-	Integrated monitoring	

Selection guide - versions with integrated heatsink (RGC)

Rated voltage	Control voltage	Connection power	Maximum rated operational current @ 40°C					
			20 AAC (525 A ² s)	25 AAC (1800 A ² s)	30 AAC (1800 A ² s)	30 AAC (6600 A ² s)	43 AAC (18000 A ² s)	65 AAC (18000 A ² s)
			Product width					
			17.5 mm	17.5 mm	22.5 mm	17.5 mm	35 mm	70 mm
230 VAC	4 - 32 VDC	Screw	RGC1A23D15KEM	-	-	RGC1A23D31KEM	-	-
		Screw	RGC1A60D15KEM	RGC1A60D25KEM	RGC1A60D30KEM	RGC1A60D31KEM	-	-
Box clamp		-	-	-	-	RGC1A60D42GEM	RGC1A60D62GEM	

Order code

 RGS1A D EM

Enter the code entering the corresponding option instead of

Code	Option	Description	Comments
R	-		
G	-	Solid State Relay (RG) without heatsink	
S	-		
1	-	Number of poles	
A	-	Switching mode: zero cross	
<input type="checkbox"/>	23	Rated voltage: 230 VAC (42-265 VAC) 50/60 Hz	
	60	Rated voltage: 600 VAC (150-660 VAC) 50/60 Hz	
D	-	Control voltage: 4-32 VDC	
<input type="checkbox"/>	25	Rated current: 25 AAC (525 A ² s)	
	50	Rated current: 50 AAC (1800 A ² s)	
	92	Rated current: 90 AAC (18000 A ² s)	
<input type="checkbox"/>	K	Screw connection for power terminals	
	G	Box clamp connection for power terminals	
E	-	Connection configuration	
M	-	Integrated monitoring	

Selection guide - versions without heatsink (RGS)

Rated voltage	Control voltage	Connection power	Maximum rated operational current		
			25 AAC (525 A ² s)	50 AAC (1800 A ² s)	90 AAC (18000 A ² s)
			Product width		
			17.5 mm	17.5 mm	17.5 mm
230 VAC	4 - 32 VDC	Screw	RGS1A23D25KEM	-	-
600 VAC		Screw	RGS1A60D25KEM	RGS1A60D50KEM	RGS1A60D92KEM
		Box clamp	-	-	RGS1A60D92GEM

Carlo Gavazzi compatible components

Description	Component code	Notes
Plugs	RG3M15AL	Spring plug labelled 'NC NO COM' Packed x10 pcs. 1 pc. included in the RG..M packaging
	RG3M15CTR	Spring plug labelled 'A1+ A2- Us+'. Packed x10 pcs. 1 pc. included in the RG..M packaging
Heatsinks	RHS...	Heatsinks for RGS models

Further reading

Information	Where to find it
Online heatsink selector tool for RGS	https://gavazziautomation.com/nsc/hq/en/solid_state_relays

Structure

RG..M

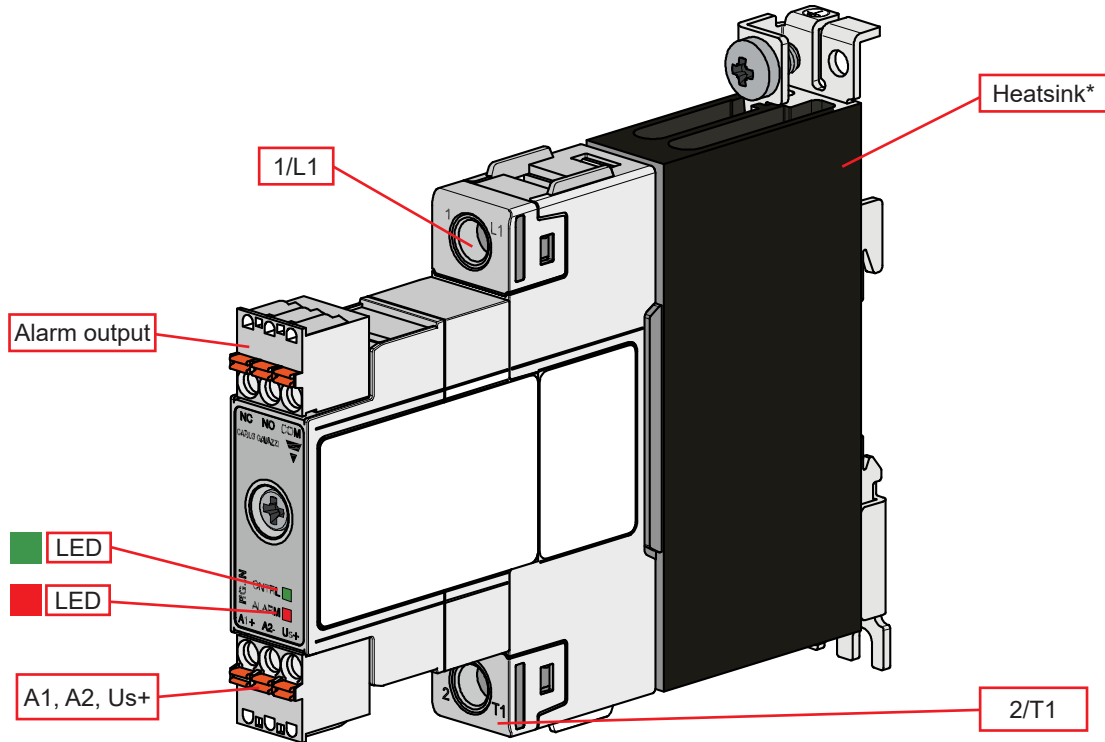

* integrated for RGC..M versions. RGS..M do not have an integrated heatsink

Element	Component	Function
1/L1	Power connection	Mains connection
2/T1	Power connection	Load connection
Alarm output	Transistor output	NC – Normally Closed NO – Normally Open COM - Common Max rating: 35VDC, 100mA
A1+, A2- Us+	Control connection Supply connection	3-pole plug for supply (Us+) and control voltage (A1+, A2-) connection
Green LED	CONTROL indicator	Flashing – Supply (Us) ON, Control (Uc) OFF ON – Supply (Us) ON, Control (Uc) ON
Red LED	ALARM indicator	Indicates the presence of an Alarm condition
Heatsink	Integrated heatsink	Integrated for RGC..M versions RGS..M versions do not have an integrated heatsink

Features

General data

Material	PA66 (UL94 V0), RAL7035 850°C, 750°C/2s according to GWIT and GWF1 requirements of EN 60335-1
Mounting	DIN rail (for RGC only) or panel
Touch Protection	IP20
Overvoltage Category	III, 6 kV (1.2/50 µs) rated impulse withstand voltage
Isolation	Input to Output: 2500 Vrms Input and Output to heatsink: 4000 Vrms
Weight	RGS..25: approx. 170 g RGS..50: approx. 170 g RGS..92: approx. 170 g RGC..15: approx. 310 g RGC..25: approx. 310 g RGC..30: approx. 425 g RGC..31: approx. 310 g RGC..42: approx. 520 g RGC..62: approx. 1030 g

Performance

▶ RGS.. Output

	RGS..23..25	RGS..60..25	RGS..60..50	RGS..60..92
Operational voltage range, Ue	42 - 265 VAC	150 - 660 VAC		
Blocking voltage	800 Vp	1200 Vp		
Switching mode	Zero cross switching			
Max. operational current: AC-51 rating ¹	25 AAC	25 AAC	50 AAC	90 AAC
Operational frequency range	50/60 Hz			
Power factor	> 0.9			
Output protection	Integrated varistor across L1-T1			
Leakage current @ rated voltage	< 5 mAAC			
Minimum operational current	150 mAAC	150 mAAC	250 mAAC	500 mAAC
Non-repetitive surge current (t=10ms)	325 Ap	325 Ap	600 Ap	1900 Ap
I ² t for fusing (t=10ms), minimum	525 A ² s	525 A ² s	1800 A ² s	18000 A ² s
LED indication - CONTROL	CONTROL ON - Green, fully ON Supply ON - Green, flashing 0.5s ON, 0.5s OFF			
Critical dV/dt (@T _J init = 40°C)	1000 V/μs			

1. Max. rated current with suitable heatsink. Refer to RGS heatsink selection tables.

▶ RGC.. Output

	RGC..23..15	RGC..60..15	RGC..60..25	RGC..60..30
Operational voltage range, Ue	42-265 VAC	150- 660 VAC		
Blocking voltage	800 Vp	1200 Vp		
Switching mode	Zero cross switching			
Max. operational current: AC-51 rating @ 25°C ²	20 AAC	20 AAC	30 AAC	30 AAC
Max. operational current: AC-51 rating @ 40°C ²	20 AAC	20 AAC	25 AAC	30 AAC
Operational frequency range	50/60 Hz			
Power factor	> 0.9			
Output protection	Integrated varistor across L1-T1			
Leakage current @ rated voltage	< 5 mAAC			
Minimum operational current	150 mAAC	150 mAAC	250 mAAC	250 mAAC
Non-repetitive surge current (t=10ms)	325 Ap	325 Ap	600 Ap	600 Ap
I ² t for fusing (t=10ms), minimum	525 A ² s	525 A ² s	1800 A ² s	1800 A ² s
LED indication - CONTROL	CONTROL ON - Green, fully ON Supply ON - Green, flashing 0.5s ON, 0.5s OFF			
Critical dV/dt (@T _J init = 40°C)	1000 V/μs			

2. Refer to RGC current derating curves for current ratings at different surrounding temperatures.

▶ RGC.. Output

	RGC..23..31	RGC..60..31	RGC..60..42	RGC..60..62
Operational voltage range, Ue	42-265 VAC	150- 660 VAC		
Blocking voltage	800 Vp	1200 Vp		
Switching mode	Zero cross switching			
Max. operational current: AC-51 rating @ 25°C ²	30 AAC	30 AAC	50 AAC	75 AAC
Max. operational current: AC-51 rating @ 40°C ²	30 AAC	30 AAC	43 AAC	65 AAC
Operational frequency range	50/60 Hz			
Power factor	> 0.9			
Output protection	Integrated varistor across L1-T1			
Leakage current @ rated voltage	< 5 mAAC			
Minimum operational current	400 mAAC	400 mAAC	500 mAAC	500 mAAC
Non-repetitive surge current (t=10ms)	1150 Ap	1150 Ap	1900 Ap	1900 Ap
I ² t for fusing (t=10ms), minimum	6600 A ² s	6600 A ² s	18000 A ² s	18000 A ² s
LED indication - CONTROL	CONTROL ON - Green, fully ON Supply ON - Green, flashing 0.5s ON, 0.5s OFF			
Critical dV/dt (@Tj init = 40°C)	1000 V/μs			

2. Refer to RGC current derating curves for current ratings at different surrounding temperatures.

▶ Inputs

Control voltage range (Uc): A1, A2	4-32 VDC
Pick-up voltage	4 VDC
Drop-out voltage	1.2 VDC
Maximum reverse voltage	32 VDC
Maximum response time pick-up	½ cycle
Response time drop-out	½ cycle
Input current @ 40°C	See diagram below

▶ Input current vs. input voltage

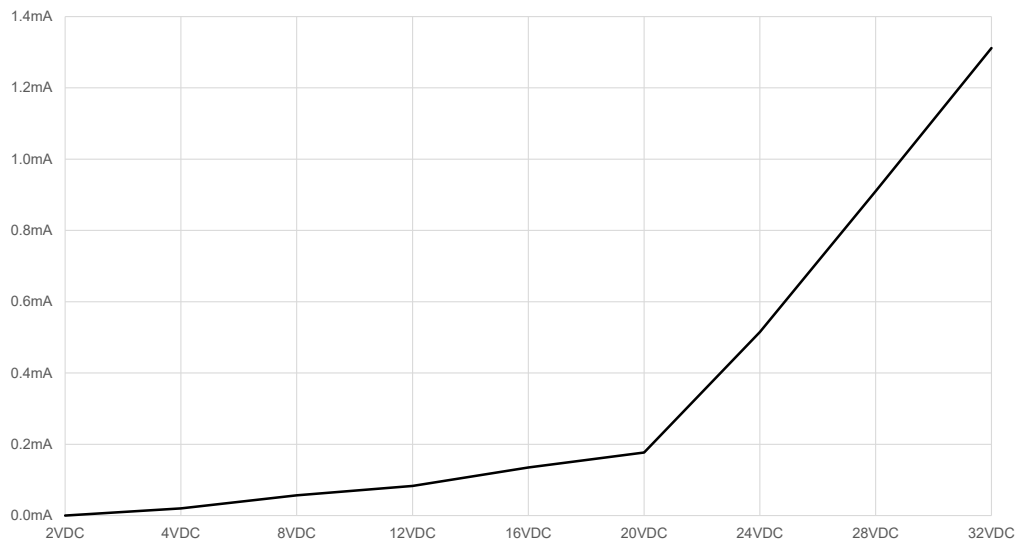

Power supply specifications

Supply port rating, Us	24 VDC
Supply voltage range, Us	19.2 – 28.8 VDC*
Reverse polarity protection	Yes
Maximum supply current	40 mA
LED Indication, Supply ON	CNTRL LED, green (flashing)

* to be supplied by class 2 power source according to UL1310

Alarm output specifications

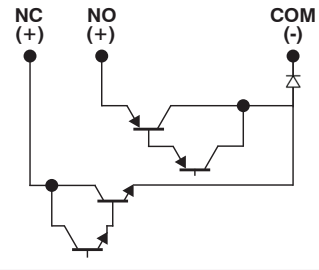
Function	Operates in case of an alarm condition present on the RG..M	
Output type	Transistor output Normally closed (NC - COM) Normally open (NO - COM)	
Output rating	35 VDC, 100 mA	
Isolation	NC, NO, COM to A1+, A2-, Us+: 500 VAC	

Output power dissipation

RGS..

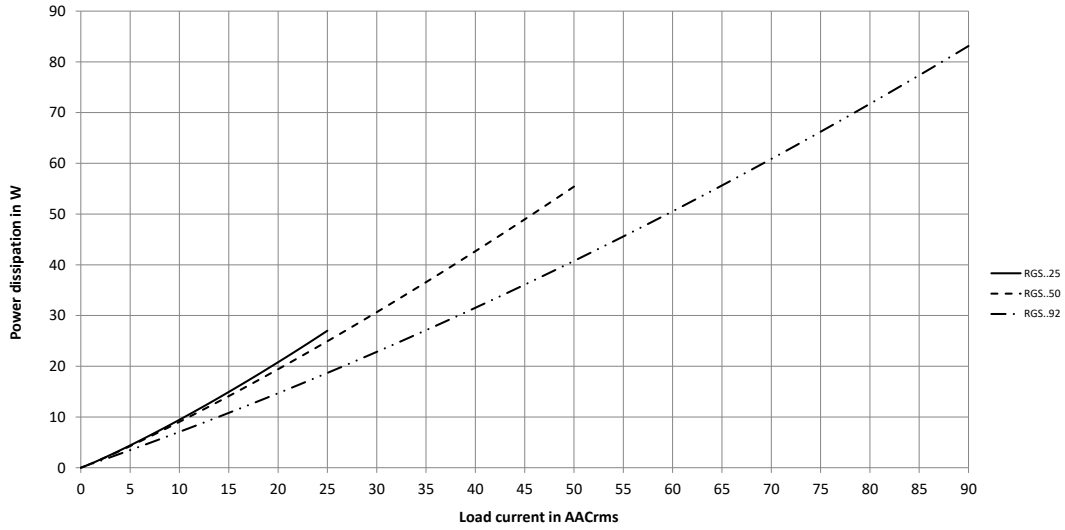

RGC..

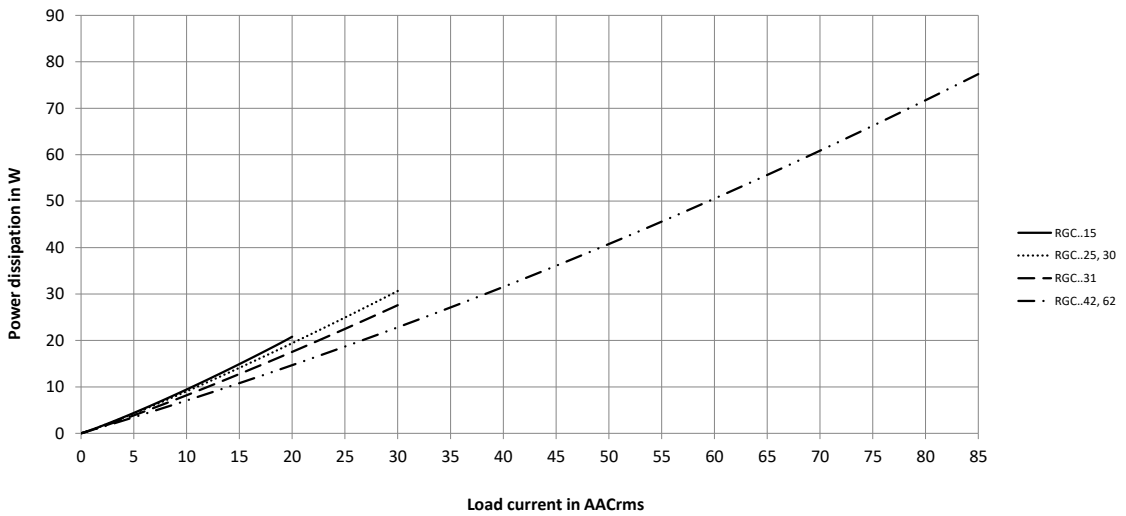

RGS.. Heatsink selection

 Thermal resistance [$^{\circ}\text{C}/\text{W}$] of RGS..25

Load current AC-51 [A]	Surrounding ambient temperature [$^{\circ}\text{C}$]					
	20	30	40	50	60	65
25	3.11	2.72	2.33	1.94	1.55	1.36
22.5	3.55	3.10	2.66	2.22	1.77	1.55
20	4.10	3.59	3.08	2.56	2.05	1.80
17.5	4.83	4.23	3.63	3.02	2.42	2.12
15	5.83	5.10	4.37	3.64	2.91	2.55
12.5	7.24	6.34	5.43	4.53	3.62	3.17
10	9.43	8.25	7.07	5.89	4.71	4.13
7.5	13.17	11.53	9.88	8.23	6.59	5.77
5	---	18.35	15.73	13.11	10.49	9.18
2.5	---	---	---	---	---	---

 Thermal resistance [$^{\circ}\text{C}/\text{W}$] of RGS..50

Load current AC-51 [A]	Surrounding ambient temperature [$^{\circ}\text{C}$]					
	20	30	40	50	60	65
50	1.45	1.28	1.06	0.87	0.68	0.59
45	1.72	1.50	1.29	1.07	0.85	0.75
40	2.00	1.75	1.50	1.25	1.00	0.87
35	2.35	2.06	1.76	1.47	1.18	1.03
30	2.83	2.48	2.13	1.77	1.42	1.24
25	3.52	3.08	2.64	2.20	1.76	1.54
20	4.58	4.01	3.44	2.86	2.29	2.01
15	6.40	5.60	4.80	4.00	3.20	2.80
10	10.19	8.92	7.64	6.37	5.10	4.46
5	--	19.51	16.72	13.94	11.15	9.76

 Thermal resistance [$^{\circ}\text{C}/\text{W}$] of RGS..92

Load current AC-51 [A]	Surrounding ambient temperature [$^{\circ}\text{C}$]					
	20	30	40	50	60	65
90	0.62	0.52	0.41	0.31	0.21	0.16
81	0.77	0.66	0.54	0.42	0.31	0.25
72	0.97	0.83	0.70	0.56	0.43	0.36
63	1.23	1.07	0.91	0.75	0.59	0.51
54	1.55	1.35	1.16	0.97	0.77	0.68
45	1.93	1.69	1.45	1.21	0.97	0.85
36	2.53	2.21	1.89	1.58	1.26	1.11
27	3.55	3.11	2.66	2.22	1.77	1.55
18	5.67	4.97	4.26	3.55	2.84	2.48
9	12.46	10.90	9.34	7.79	6.23	5.45

▶ RGS.. Thermal data

	RGS..25	RGS..50	RGS..92
Max. junction temperature	125°C		
Heatsink temperature	100°C		
Junction to case thermal resistance, R_{thjc}	< 0.45°C/W	< 0.30 °C/W	< 0.20 °C/W
Case to heatsink thermal resistance, R_{thcs}	< 0.25 °C/W		

▶ RGC.. Current derating

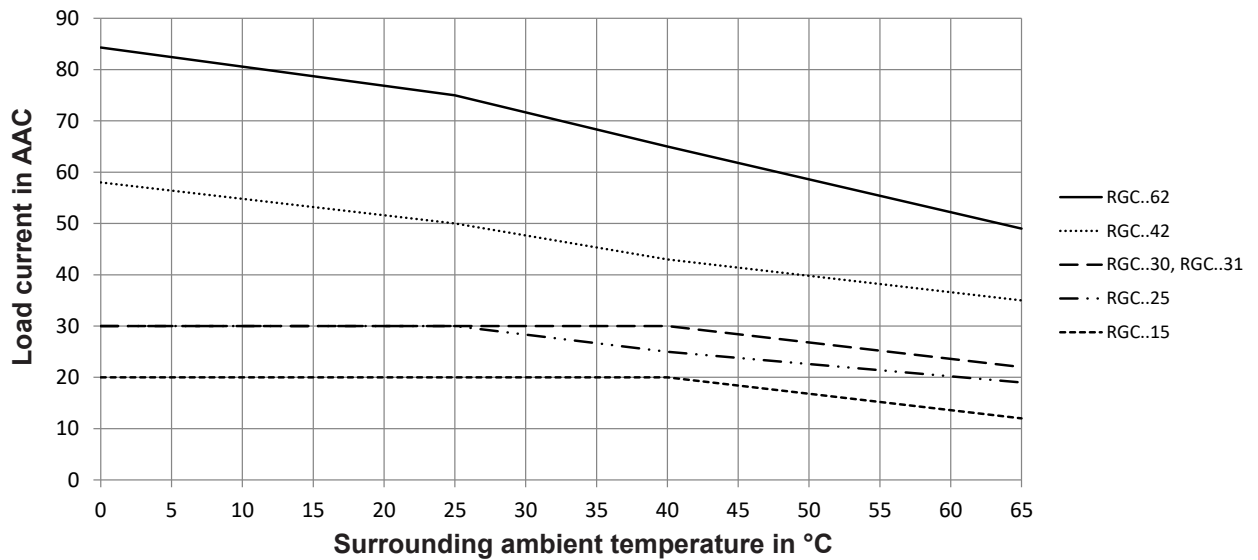

RGC.. Derating vs spacing

RGC...15

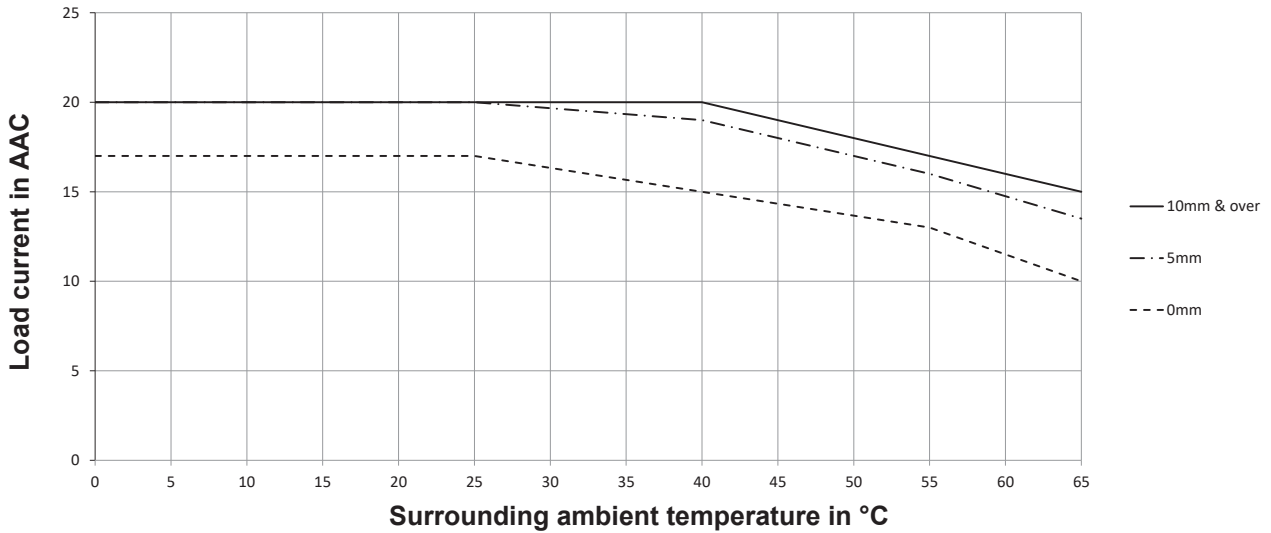

RGC...25

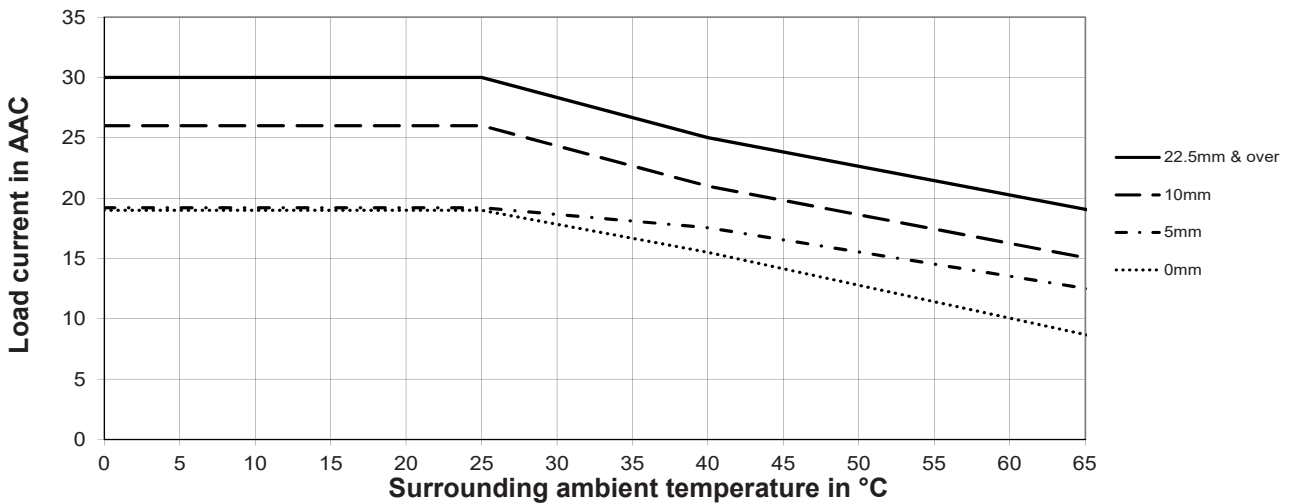

RGC...30

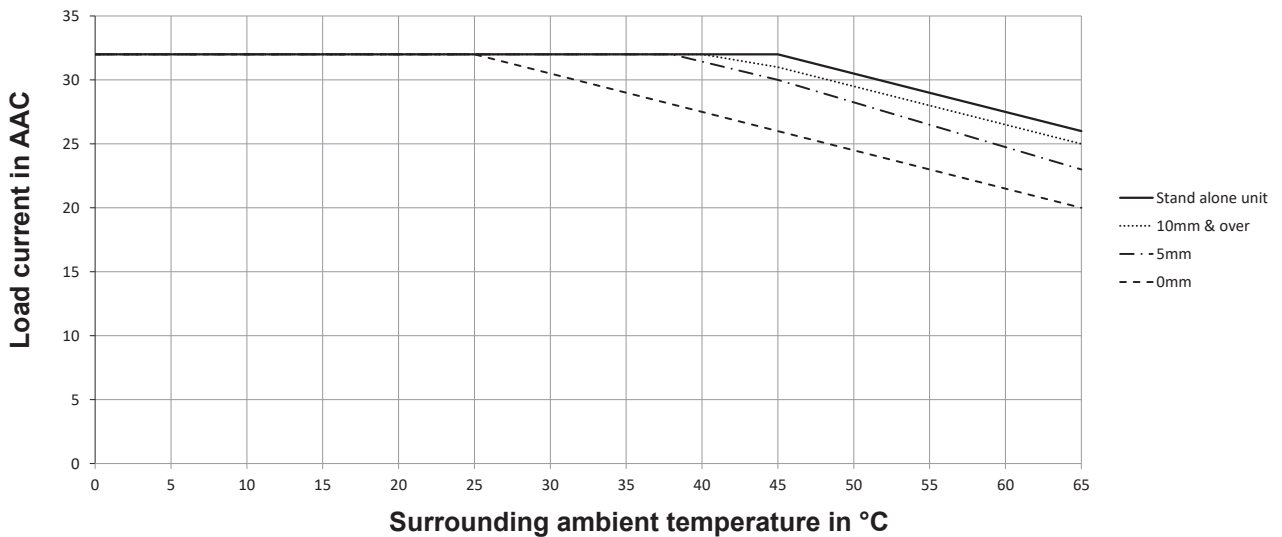

RGC.. Derating vs spacing

RGC...31

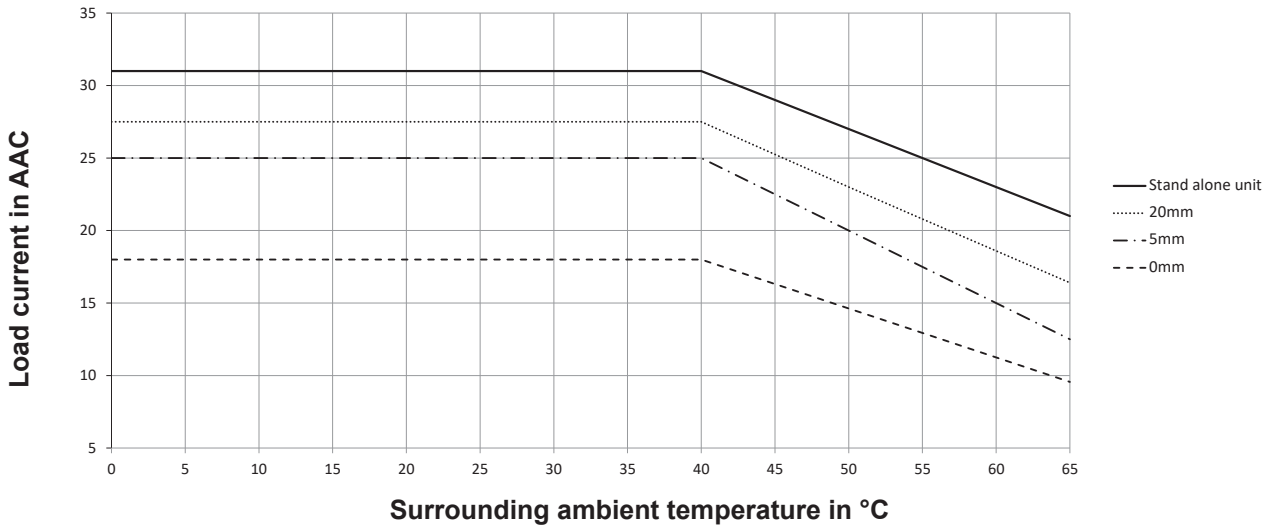

RGC...42

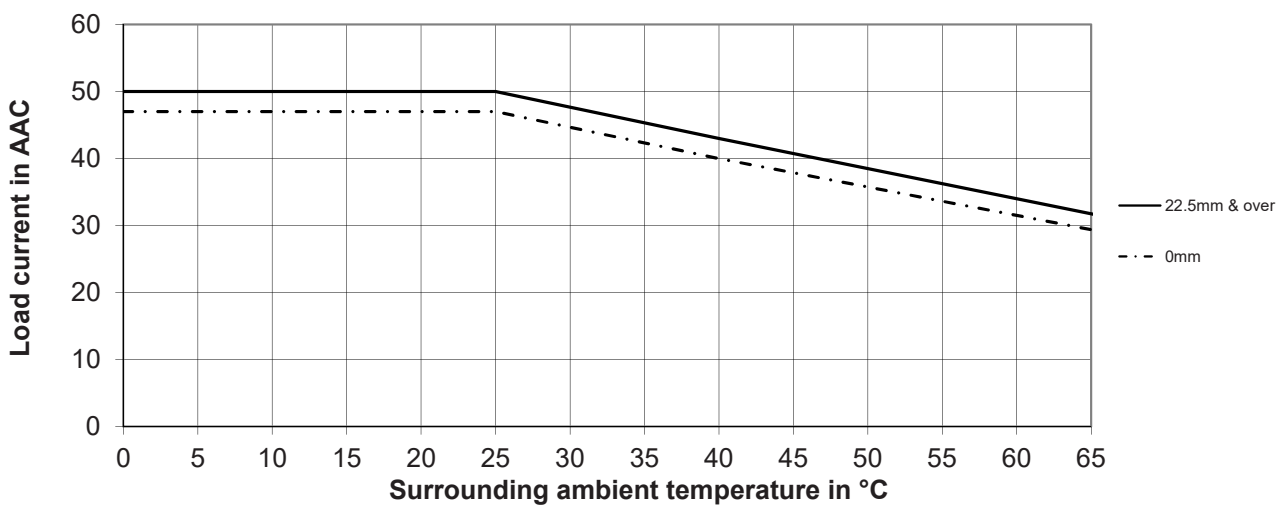



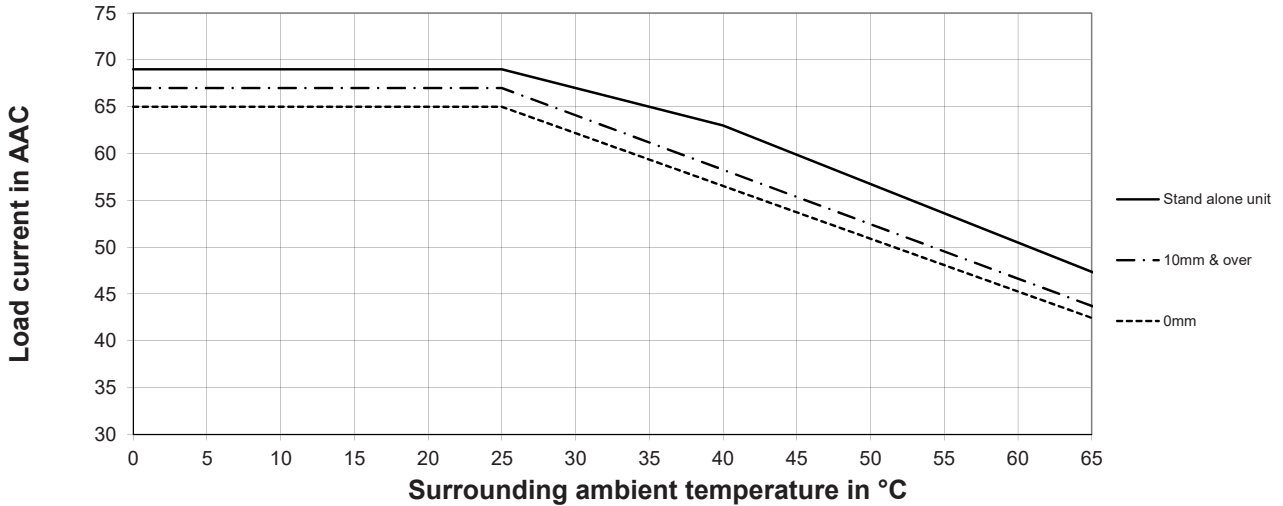





RGC...62





Compatibility and conformance

Approvals	RGC:    	
	RGS:     	
Standards compliance	RGC:	RGS:
	LVD: EN 60947-4-3 EMCD: EN 60947-4-3 EE: EN 60947-4-3 EMC: EN 60947-4-3 UL: UL508 (E172877), NMFT cUL: C22.2 No. 14 (E172877), NMFT7	LVD: EN 60947-4-3 EMCD: EN 60947-4-3 EE: EN 60947-4-3 EMC: EN 60947-4-3 cURus: UL508 Recognised (E172877), NMFT2, NMFT8 CSA: C22.2 No. 14 (204075)
UL short circuit current rating	100 kArms (refer to short circuit current section, Type 1 – UL508)	

Electromagnetic compatibility (EMC) - Immunity	
Electrostatic discharge (ESD)	EN/IEC 61000-4-2 8 kV air discharge, 4 kV contact (PC1)
Radiated radio frequency	EN/IEC 61000-4-3 10 V/m, from 80 MHz to 1 GHz (PC1) 10 V/m, from 1.4 to 2 GHz (PC1) 3 V/m, from 2 to 2.7 GHz (PC1)
Electrical fast transient (burst)	EN/IEC 61000-4-4 Output: 2 kV, 5 kHz & 100 kHz (PC1) Input: 1 kV, 5 kHz & 100 kHz (PC2)
Conducted radio frequency ³	EN/IEC 61000-4-6 10V/m, from 0.15 to 80 MHz (PC1)
Electrical surge	EN/IEC 61000-4-5 Output, line to line: 1 kV (PC2) Output, line to earth: 2 kV (PC2) Input, line to line: 1.1 kV (PC2) Input, line to earth: 2.2 kV (PC2) Signal, line to line: 500V (PC1) Signal, line to earth: 500 V (PC1) NC, NO, COM, line to line: 500 V (PC1) NC, NO, COM, line to earth: 500 V (PC1)
Voltage dips	EN/IEC 61000-4-11 0% for 0.5, 1 cycle (PC2) 40% for 10 cycles (PC2) 70% for 25 cycles (PC2) 80% for 250 cycles (PC2)
Voltage interruptions	EN/IEC 61000-4-11 0% for 5000ms (PC2)

3. External Power Supply & Control inputs must be installed together to maintain products susceptibility to Radio Interference. Alarm output lines (NO NC COM) must be installed together to maintain products susceptibility to Radio Interference.

Electromagnetic compatibility (EMC) - Emissions	
Radio interference field emission (radiated)	EN/IEC 55011 Class A: from 30 to 1000 MHz
Radio interference voltage emissions (conducted)	EN/IEC 55011 Class A: from 0.15 to 30 MHz (External filter may be required - refer to Filtering section)

Filter connection diagram

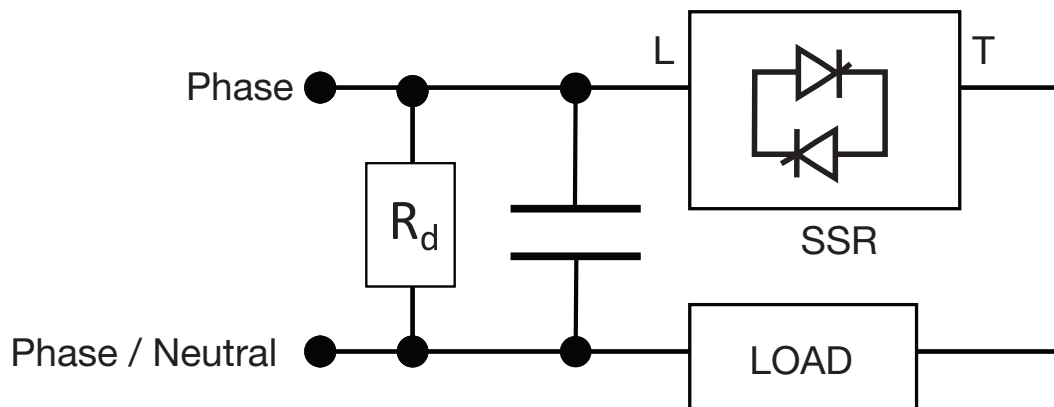

$R_d = 1M\Omega, 0.5W$

Filtering

Part number	Suggested filter for EN 55011 Class A compliance	Maximum heater current [AAC]
RGS..25	220 nF / xxx V / X1	25 A
RGS..50	330 nF / xxx V / X1	45 A
RGS..92	680 nF / xxx V / X1	65 A
RGC..15	100 nF / xxx V / X1	20 A
RGC..25	220 nF / xxx V / X1	25 A
RGC..30	220 nF / xxx V / X1	30 A
RGC..31	330 nF / xxx V / X1	30 A
RGC..42	330 nF / xxx V / X1	40 A
RGC..62	680 nF / xxx V / X1	65 A

xxx = 275 for RGS1A23..., RGC1A23...

xxx = 760 for RGS1A60..., RGC1A60...

Note:

- Control input lines must be installed together to maintain products' susceptibility to Radio Frequency interference.
- Use of AC solid state relays may, according to the application and the load current, cause conducted radio interferences. Use of mains filters may be necessary for cases where the user must meet E.M.C requirements. The capacitor values given inside the filtering specification tables should be taken only as indications, the filter attenuation will depend on the final application.
- Performance Criteria 1 (PC1): No degradation of performance or loss of function is allowed when the product is operated as intended.
- Performance Criteria 2 (PC2): During the test, degradation of performance or partial loss of function is allowed. However when the test is complete the product should return operating as intended by itself.
- Performance Criteria 3 (PC3): Temporary loss of function is allowed, provided the function can be restored by manual operation of the controls.

Environmental specifications

Operating temperature	-20 to +65 °C (-4 to +149 °F)
Storage temperature	-40 to +100 °C (-40 to +212 °F)
Relative humidity	95% non-condensing @ 40°C
Pollution degree	2
Installation altitude	0-1000 m. Above 1000 m derate linearly by 1% of FLC per 100m up to a maximum of 2000 m
Vibration resistance	2g / axis (2-100Hz, IEC60068-2-6, EN 50155)
Impact resistance	15/11 g/ms (EN 50155)
EU RoHS compliant	Yes
China RoHS	

The declaration in this section is prepared in compliance with People’s Republic of China Electronic Industry Standard SJ/T11364-2014: Marking for the Restricted Use of Hazardous Substances in Electronic and Electrical Products.

Part Name	Toxic or Harardous Substances and Elements					
	Lead (Pb)	Mercury (Hg)	Cadmium (Cd)	Hexavalent Chromium (Cr(VI))	Polybrominat-ed biphenyls (PBB)	Polybromi-nated diphenyl ethers (PBDE)
Power Unit Assembly	x	o	o	o	o	o

O: Indicates that said hazardous substance contained in homogeneous materials fot this part are below the limit requirement of GB/T 26572.

X: Indicates that said hazardous substance contained in one of the homogeneous materials used for this part is above the limit requirement of GB/T 26572.

这份申明根据中华人民共和国电子工业标准 SJ/T11364-2014：标注在电子电气产品中限定使用的有害物质

零件名称	有毒或有害物质与元素					
	铅 (Pb)	汞 (Hg)	镉 (Cd)	六价铬 (Cr(VI))	多溴化联苯 (PBB)	多溴联苯醚 (PBDE)
功率单元	x	o	o	o	o	o

O:此零件所有材料中含有的该有害物低于GB/T 26572的限定。

X: 此零件某种材料中含有的该有害物高于GB/T 26572的限定。

Mode of operation

The RG..M has integrated monitoring circuitry that can detect the status of the mains, load, and Solid State relay (SSR) status. The fault conditions that can be detected with the RG..M include:

- System fault (mains loss, load loss, SSR open circuit, SSR short circuit)
- Supply out of range
- Internal error

In case of a fault condition, a transistor alarm output is available through terminals NO, NC, COM for remote signalling. Alarm visual indication is provided by a flashing red LED. The flash rate of the red LED gives an indication of the type of alarm condition detected (See 'LED Indicators' and 'Alarm Management' sections for further details).

	Supply Voltage, Us+ loss	Supply Voltage, Us+ out of range	Normal operation, SSR OFF	Normal operation, SSR ON
Line Voltage; 1L1	Black	White	White	White
Load Voltage; 2T1	White	White	White	Black
Load Current	White	White	White	Black
Control Voltage; A1+, A2-	White	Black	White	Black
Supply Voltage; Us+	White	Black	White	Black
Green LED (control & supply)	White	Flashing	Flashing	White
Red LED (alarm)	White	Flashing	White	White
Alarm Output (NC); NC, COM	Black	Open	Black	Black
Alarm Output (NO); NO, COM	Open	Black	Open	Open

System Fault Alarm:

System fault alarm is indicated by 2 flashes of the red LED and includes the scenarios indicated below.

	Mains loss	Load loss	SSR short circuit	SSR open circuit
Line Voltage; 1L1	Black	White	White	White
Load Voltage; 2T1	White	White	Black	White
Load Current	White	White	Black	White
Control Voltage; A1+, A2-	White	Black	White	Black
Supply Voltage; Us+	Black	Black	White	Black
Green LED (control & supply)	Flashing	Flashing	Flashing	White
Red LED (alarm)	2 Flashes	2 Flashes	2 Flashes	White
Alarm Output (NC); NC, COM	Open	Open	Open	Open
Alarm Output (NO); NO, COM	Black	Black	Black	Black

Mains loss:

The mains loss alarm is issued if the mains voltage is missing from terminal L1 for more than 100ms⁴. The alarm resets automatically once the mains voltage is restored and is present on terminal L1 for more than 100ms.

Load loss:

Detection of load loss is possible both with control voltage ON and control voltage OFF. This alarm is issued in the absence of a load termination or an open load on terminal T1 exceeding 100ms⁴. The minimum duty cycle at which a load loss can be detected is 1/2 cycle ON, 1/2 cycle OFF. The fault condition is automatically restored once the fault is cleared.

Short circuit:



This condition is detected when the SSR output remains ON for more than 250ms without control voltage. In case of a self-recovery, the SSR will automatically reset. During an SSR short circuit condition, the SSR output is ON unintentionally.

Open circuit:

This alarm is issued when the SSR does not switch ON within 250ms from when control voltage is applied.

4. On start up reaction and recovery times may be longer (<200 ms)

LED indicators

CNTRL	Green 	ON:	Supply ON, Control ON
		Flashing:	Supply ON, Control OFF
ALARM	Red 	ON:	Fully ON or flashing when alarm condition is present. Refer to Alarm Management section
		OFF:	No alarm condition

Alarm management

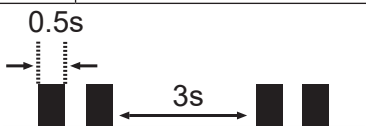
Alarm condition present	<ul style="list-style-type: none"> The state of the Red LED of the RG..M is ON with a specific flashing rate Alarm output operates 	
Alarm types	No. of flashes	Description of fault
	100% ON	SSR Internal error
	2	System fault (mains loss, load loss, SSR open circuit or SSR short circuit)
	3	Supply out of range (Typical < 18 VDC or > 30 VDC)
Flashing rate		

Short circuit protection

Protection Co-ordination, Type 1 vs Type 2:

Type 1 protection implies that after a short circuit, the device under test will no longer be in a functioning state. In Type 2 co-ordination the device under test will still be functional after the short circuit. In both cases, however the short circuit has to be interrupted. The fuse between enclosure and supply shall not open. The door or cover of the enclosure shall not be blown open. There shall be no damage to conductors or terminals and the conductors shall not separate from terminals. there shall be no breakage or cracking of insulating bases to the extent that the integrity of the mounting of live parts is impaired. Discharge of parts or any risk of fire shall not occur.

The product variants listed in the table hereunder are suitable for use on a circuit capable of delivering not more than 100,000 Arms Symmetrical Amperes, 600 Volts maximum when protected by fuses. Tests at 100,000A were performed with Class J fuses, fast acting; please refer to the table below for maximum allowed ampere rating of the fuse. Use fuses only.

Tests with Class J fuses are representative of Class CC fuses.

Protection co-ordination Type 1 according to UL 508				
Part No.	Prospective short circuit current [kArms]	Max fuse size [A]	Class	Voltage [VAC]
RGS..25, RGS..50 RGC..15, RGC..25, RGC..30, RGC..31	100	30	J or CC	max. 600
RGS..92 RGC..42, RGC..62	100	80	J	max. 600

Protection co-ordination Type 2 with semiconductor fuses						
Part No.	Prospective short circuit current [kArms]	Ferraz Shawmut		Siba		Voltage [VAC]
		Max fuse size [A]	Part number	Max fuse size [A]	Part number	
RGC..15	10	25	6.9xx CP GRC 14x51 /25	32	50 142 06.32	max. 600
	100	25	6.9xx CP GRC 14x51 /25	32	50 142 06.32	max. 600
RGC..25 RGC..30 RGS..25	10	40	6.9xx CP GRC 22x58 /40	32	50 142 06.32	max. 600
	100	40	6.9xx CP GRC 22x58 /40	32	50 142 06.32	max. 600
RGC..42	10	63	6.9xx CP URC 14x51 /63	80	50 194 20.80	max. 600
	10	70	A70QS70-4	80	50 194 20.80	max. 600
	100	63	6.9xx CP URC 14x51 /63	80	50 194 20.80	max. 600
	100	70	A70QS70-4	80	50 194 20.80	max. 600
RGC..62	10	100	6.9xx CP GRC 22x58 /100	100	50 194 20.100	max. 600
	10	100	A70QS100-4	100	50 194 20.100	max. 600
	100	100	6.621 CP URGD 27x60 /100	100	50 194 20.100	max. 600
	100	100	A70QS100-4	100	50 194 20.100	max. 600
RGS..50	10	80	6.621 CP URQ 27x60 /80	50	50 142 06.50	max. 660
	10	70	A70QS70-4	50	50 142 06.50	max. 660
	100	80	6.621 CP URQ 27x60 /80	50	50 142 06.50	max. 660
	100	70	A70QS70-4	50	50 142 06.50	max. 660
RGS..92	10	125	6.621 CP URD 22x58 /125	125	50 194 20.125	max. 660
	10	125	A70QS125-4	125	50 194 20.125	max. 660
	100	125	6.621 CP URD 22x58 /125	125	50 194 20.125	max. 660
	100	125	A70QS125-4	125	50 194 20.125	max. 660

Protection co-ordination Type 2 with Miniature Circuit Breakers (M.C.B.s)				
Solid State Relay type	ABB Model no. for Z - type M. C. B. (rated current)	ABB Model no. for B - type M. C. B. (rated current)	Wire cross sectional area [mm ²]	Minimum length of Cu wire conductor [m] ²
RGS..25 RGC..15 (525 A ² s)	1-pole		1.0	21.0
	S201 - Z4 (4 A)	S201 - B2 (2 A)	1.0	21.0
	S201 - Z6 UC (6 A)	S201 - B2 (2 A)	1.5	31.5
RGS..50 RGC..25, RGC..30 (1800 A ² s)	1-pole		1.0	7.6
	S201 - Z10 (10 A)	S201-B4 (4 A)	1.5	11.4
			2.5	19.0
	S201 - Z16 (16 A)	S201-B6 (6 A)	1.0	5.2
			1.5	7.8
			2.5	13.0
			4.0	20.8
	S201 - Z20 (20 A)	S201-B10 (10 A)	1.5	12.6
			2.5	21.0
	S201 - Z25 (25 A)	S201-B13 (13 A)	2.5	25.0
		4.0	40.0	
RGC..31 (6600 A ² s)	2-pole		2.5	19.0
	S202 - Z25 (25 A)	S202-B13 (13 A)	4.0	30.4
	1-pole		1.5	4.2
	S201 - Z20 (20 A)	S201-B10 (10 A)	2.5	7.0
			4.0	11.2
	S201 - Z32 (32 A)	S201-B16 (16 A)	2.5	13.0
			4.0	20.8
			6.0	31.2
	2-pole		1.5	1.8
	S202 - Z20 (20 A)	S202-B10 (10 A)	2.5	3.0
		4.0	4.8	
S202 - Z32 (32 A)	S202-B16 (16 A)	2.5	5.0	
		4.0	8.0	
		6.0	12.0	
		10.0	20.0	
S202 - Z50 (50 A)	S202-B25 (25 A)	4.0	14.8	
		6.0	22.2	
		10.0	37.0	
RGS..92 RGC..42, RGC..62 (18000 A ² s)	1-pole		2.5	3.0
	S201 - Z32 (32 A)	S201-B16 (16 A)	4.0	4.8
			6.0	7.2
	S201 - Z50 (50 A)	S201-B25 (25 A)	4.0	4.8
			6.0	7.2
			10.0	12.0
			16.0	19.2
S201 - Z63 (63 A)	S201-B32 (32 A)	6.0	7.2	
		10.0	12.0	
		16.0	19.2	

5. Between MCB and Load (including return path which goes back to the mains)

Note: A prospective current of 6 kA and a 230 / 400 V power supply is assumed for the above suggested specifications. For cables with different cross section than those mentioned above please consult Carlo Gavazzi's Technical Support Group.

Dimensions

RGS..KEM

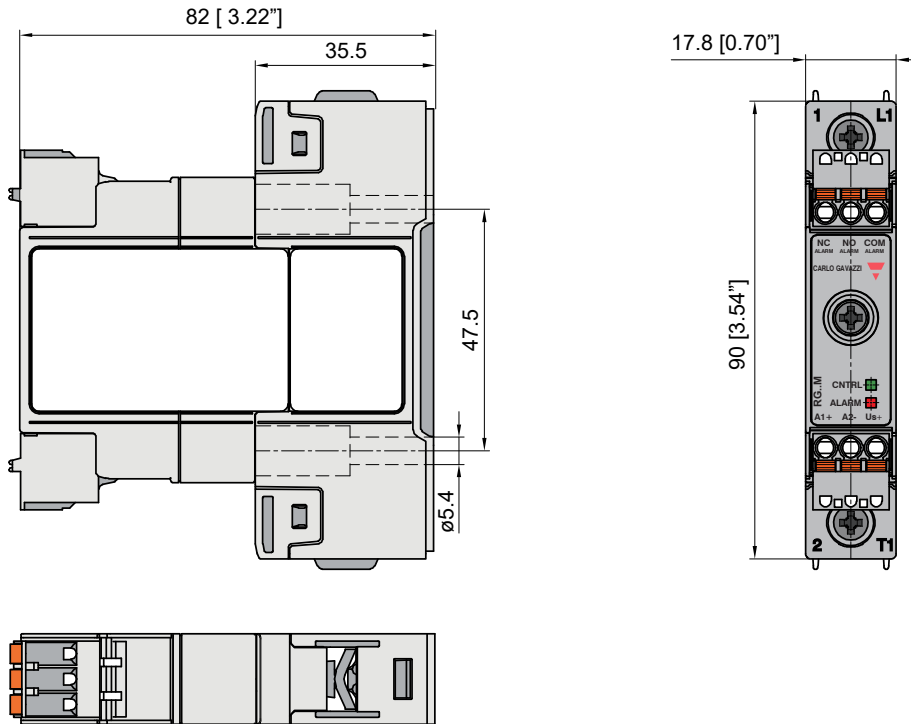

RGS..GEM

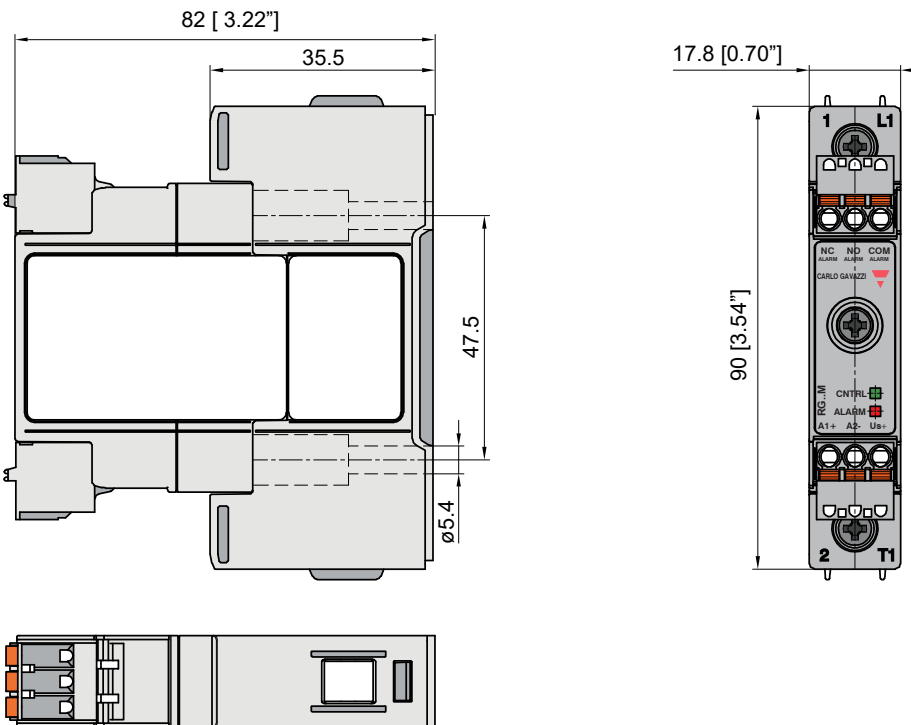

Housing width tolerance +0.5mm, -0mm as per DIN 43880.
 All other tolerances +/- 0.5mm.
 Dimensions in mm.

Dimensions

RGC..15KEM, RGC..25KEM, RGC..31KEM

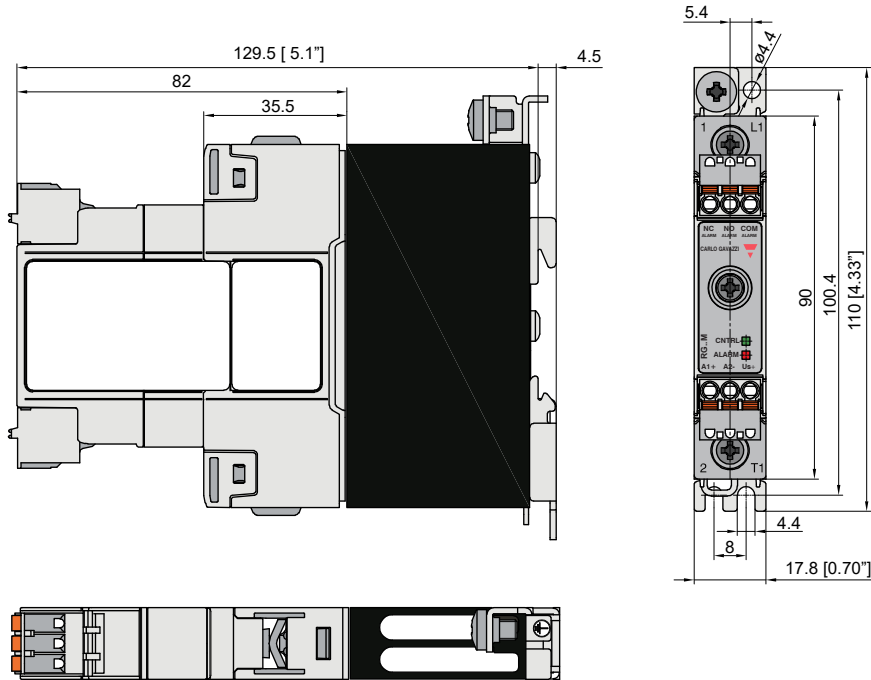

RGC...30KEM

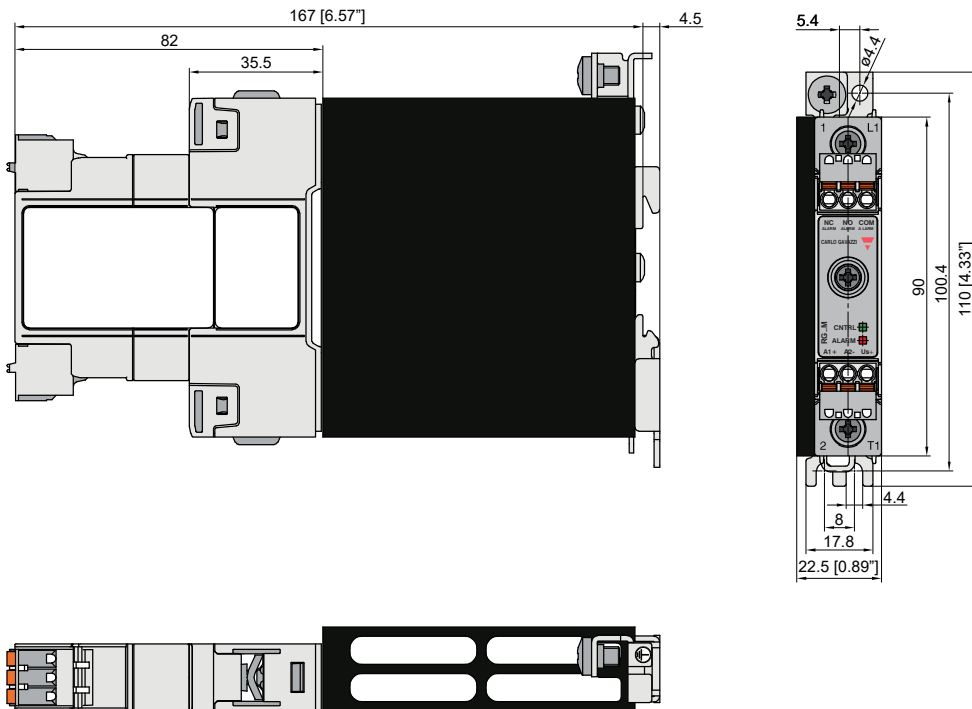

Housing width tolerance +0.5mm, -0mm as per DIN 43880.
 All other tolerances +/- 0.5mm.
 Dimensions in mm.

► Dimensions

RGC..42GEM

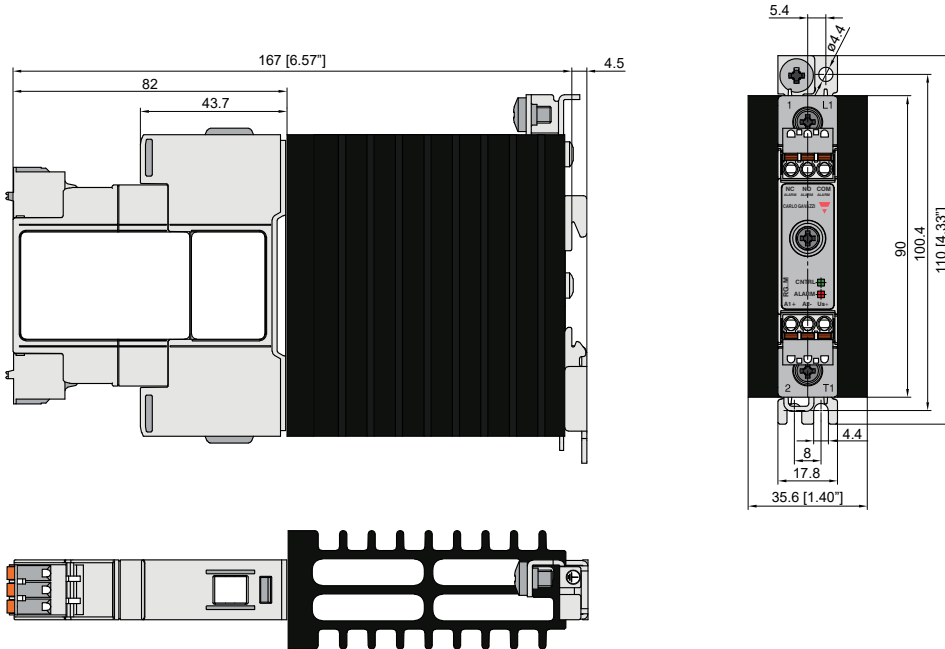

RGC..62GEM

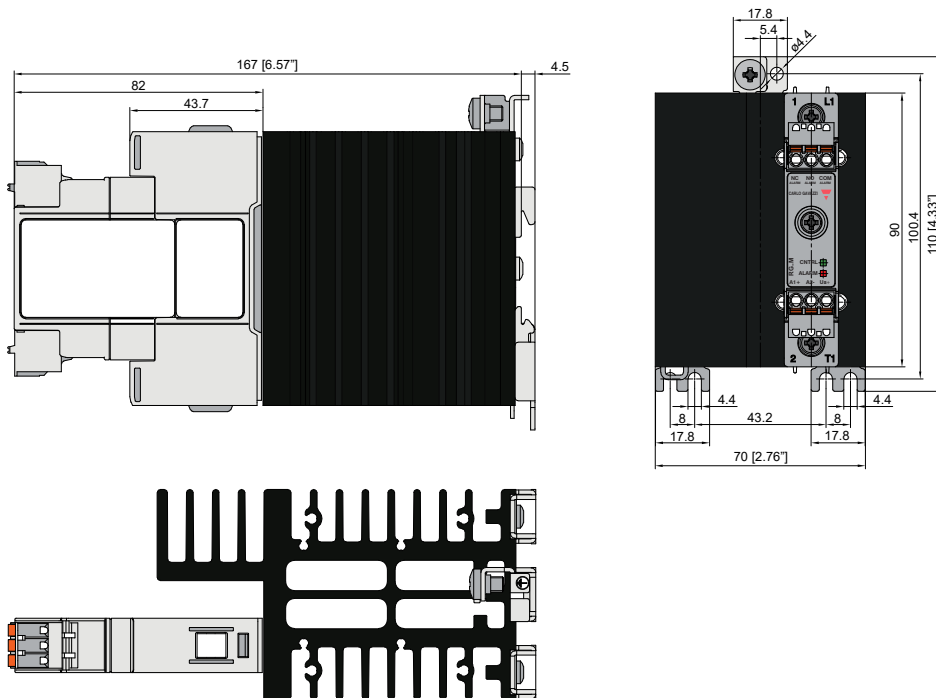

Housing width tolerance +0.5mm, -0mm as per DIN 43880.
 All other tolerances +/- 0.5mm.
 Dimensions in mm.

Connection diagram

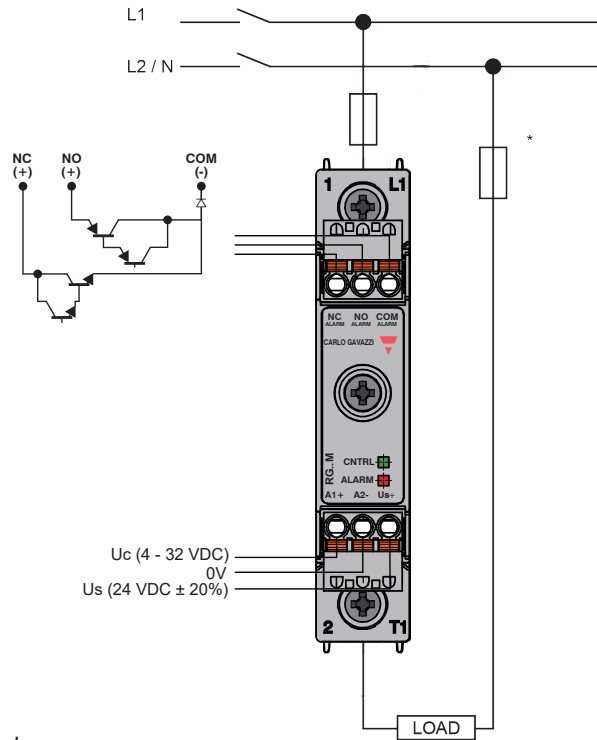

*depends on system requirements

Functional diagram

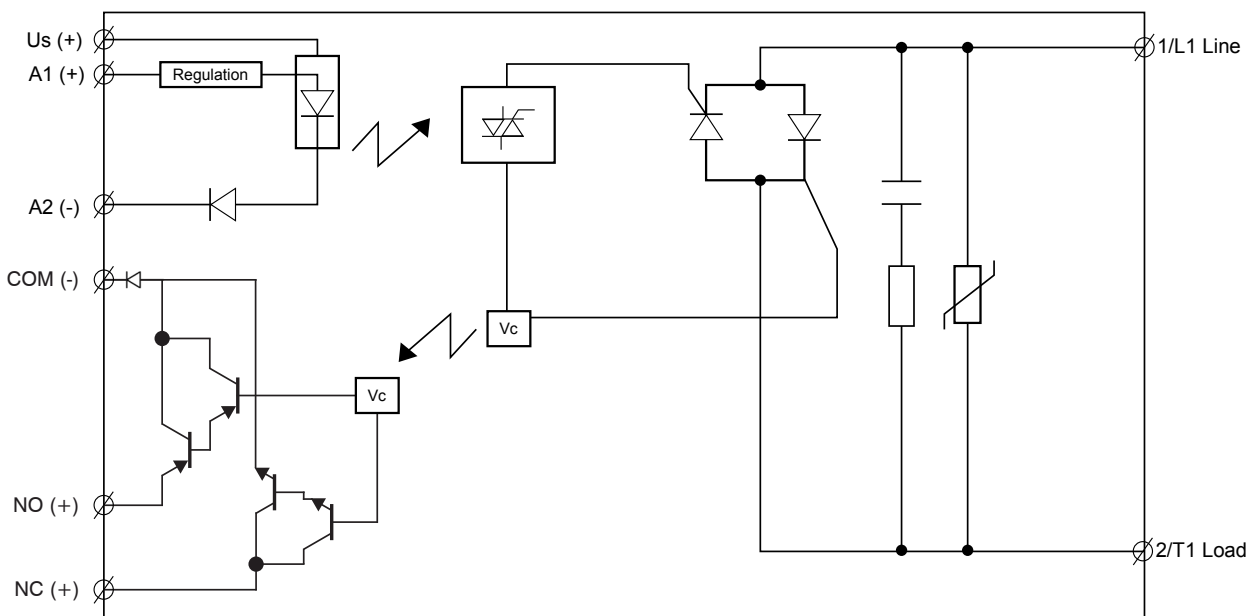

▶ Mounting

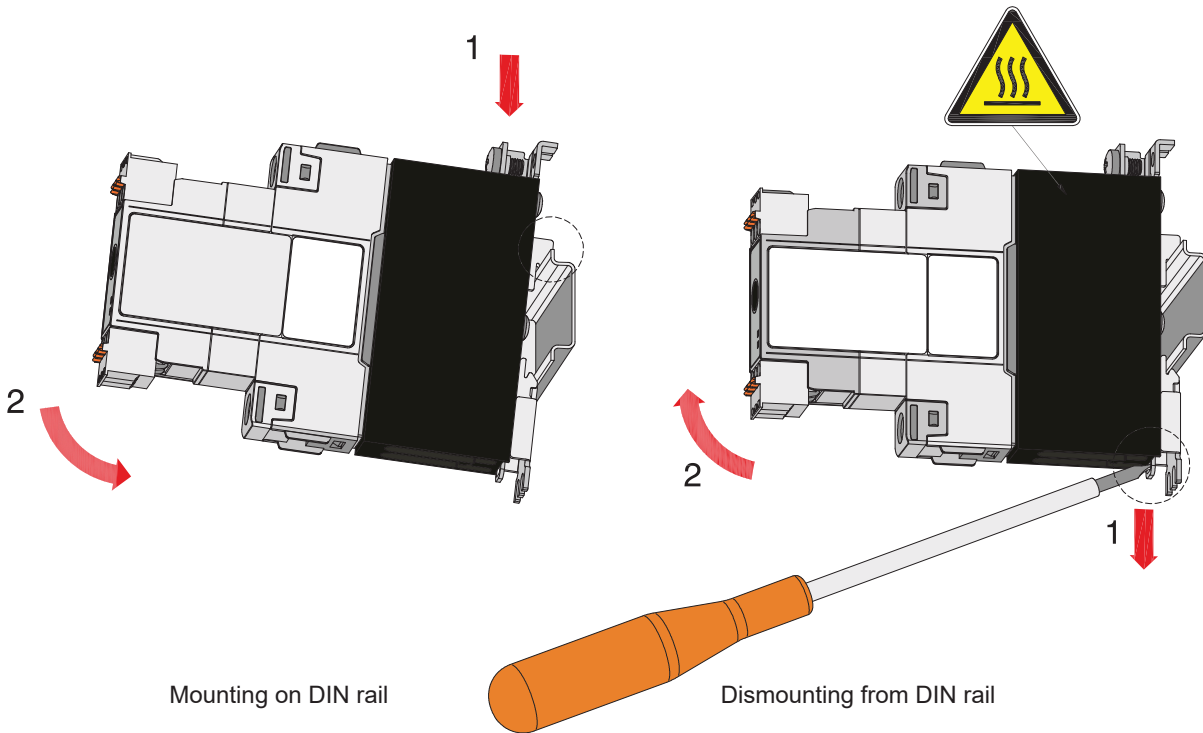

Mounting on DIN rail

Dismounting from DIN rail

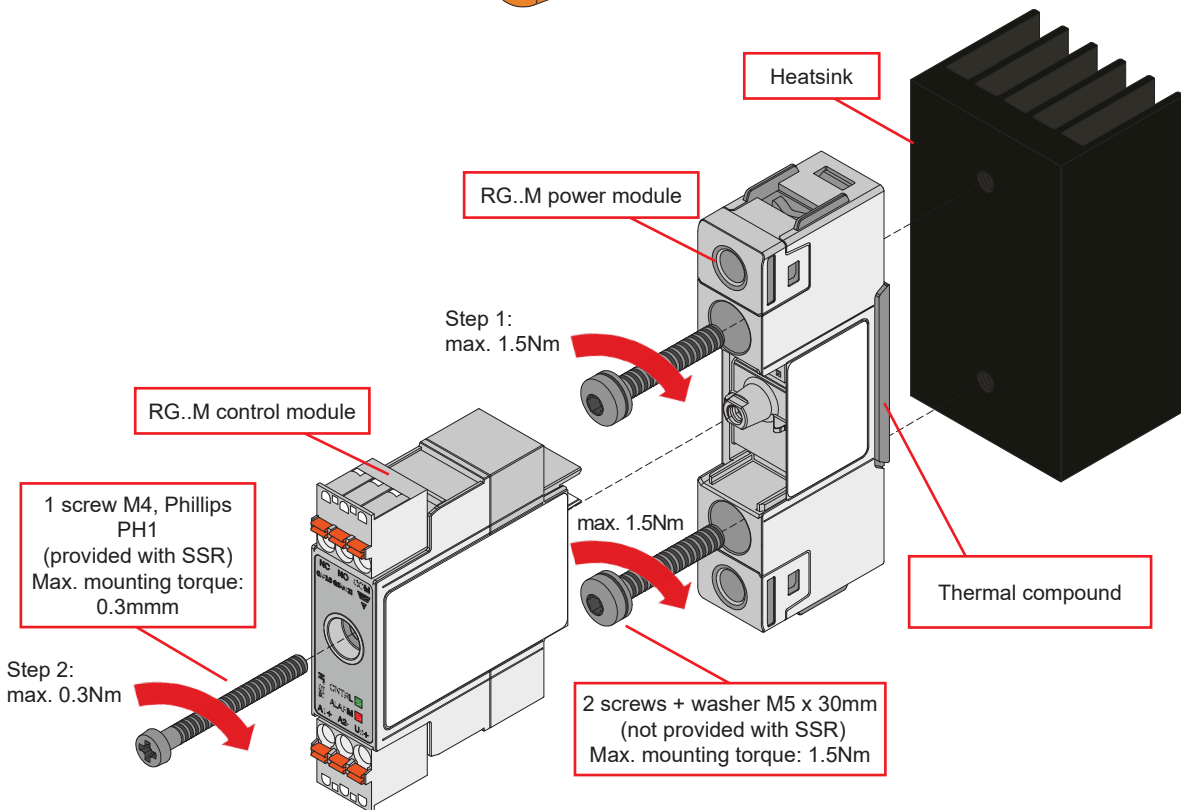

Step 1: Mount RG..M power module to heatsink
 Step 2: Mount RG..M control module on RG..M power module

Installation

X = Refer to Derating vs. Spacing Curves

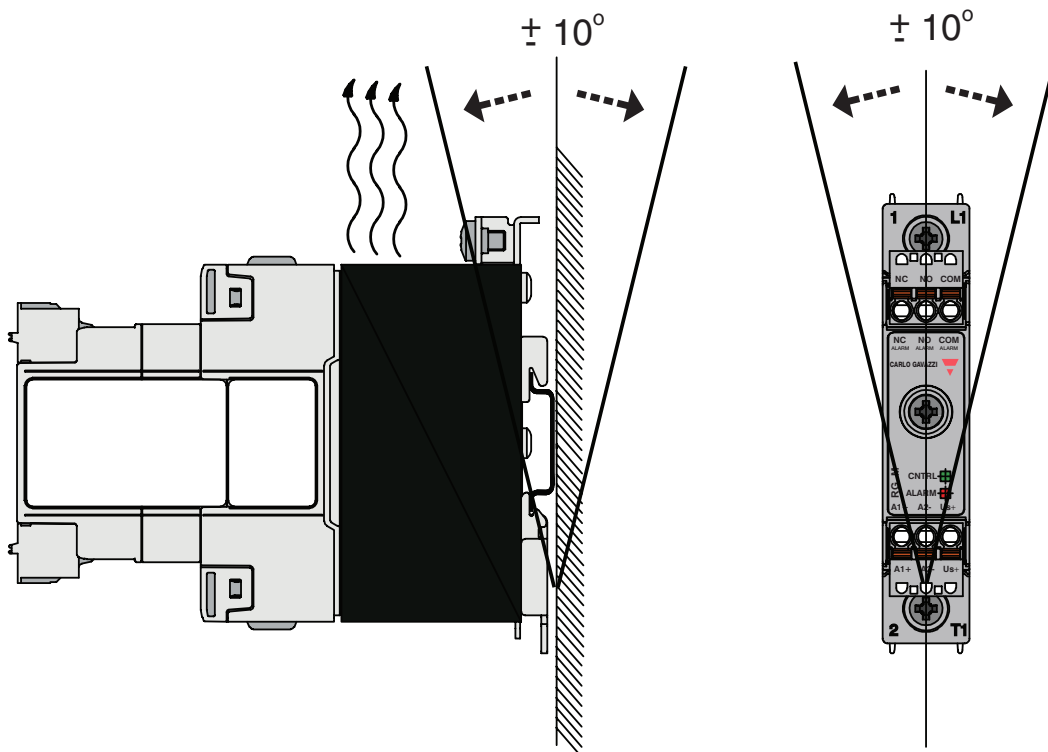
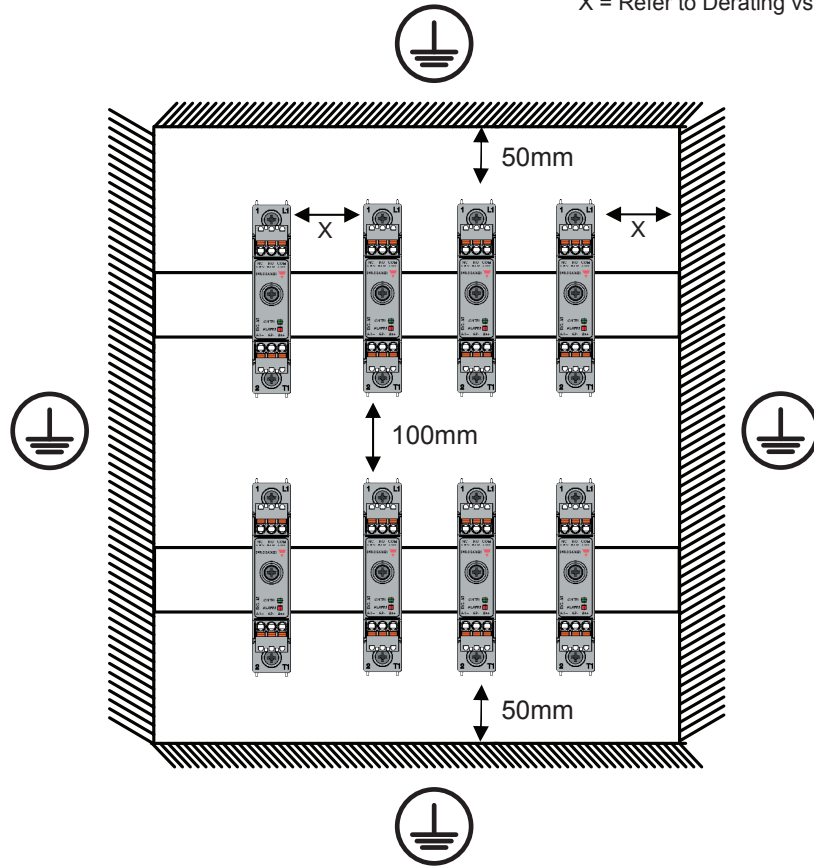

Connection specifications

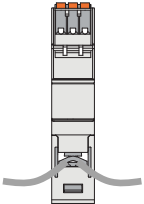
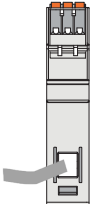
Power connection			
Terminal	1/L1, 2/T1		
Conductors	Use 75°C copper (Cu) conductors		
	RG..KEM	RG..GEM	
			
Stripping length	12 mm	11 mm	
Connection type	M4 screw with captivated washer	M5 screw with box clamp	
Rigid (solid & stranded) UL/CSA rated data	2x 2.5 – 6.0 mm ² 2x 14 – 10 AWG	1x 2.5 – 6.0 mm ² 1x 14 – 10 AWG	1x 2.5 – 25.0 mm ² 1x 14 – 3 AWG
Flexible with end sleeve	2x 1.0 – 2.5 mm ² 2x 2.5 – 4.0 mm ² 2x 18 – 14 AWG 2x 14 – 12 AWG	1x 1.0 – 4.0 mm ² 1x 18 – 12 AWG	1x 2.5 – 16.0 mm ² 1x 14 – 6 AWG
Flexible without end sleeve	2x 1.0 – 2.5 mm ² 2x 2.5 – 6.0 mm ² 2x 18 – 14 AWG 2x 14 – 10 AWG	1x 1.0 – 6.0 mm ² 1x 18 – 10 AWG	1x 4.0 – 25.0 mm ² 1x 12 – 3 AWG
Torque specifications	Posidrive bit 2 UL: 2.0 Nm (17.7 lb-in) IEC: 1.5 – 2.0 Nm (13.3 – 17.7 lb-in)	Posidrive bit 2 UL: 2.5 Nm (22 lb-in) IEC: 2.5 – 3.0 Nm (22 – 26.6 lb-in)	
Aperture for termination lug (fork or ring)	12.3 mm	n/a	
Protective Earth (PE) connection	M5, 1.5 Nm (13.3 lb-in) M5 PE screw is not provided with the solid state relay. PE connection is required when product is intended to be used in Class 1 applications according to EN/IEC 61140		

Control, supply and alarm connection	
Terminals	A1+, A2-, Us+, NC, NO, COM
	 <p>Front view</p>
Conductors	Use 60/75°C copper (Cu) conductors
Stripping length	8 – 10 mm
Connection type	Spring plug, pitch 5.00 mm
Rigid (solid & stranded) UL/CSA rated data	0.2 – 2.5 mm ² , 26 – 12 AWG
Flexible with end sleeve	0.25 – 2.5 mm ²
Flexible without end sleeve	0.25 – 2.5 mm ²
Flexible with end sleeve using TWIN ferrules	0.5 – 1.0 mm ²



COPYRIGHT ©2023
 Content subject to change.
 Download the PDF: <https://gavazziautomation.com>