

### AMY-50-S-C

~18° spot beam. Assembly with holder C compatible with LEDiL HEKLA. Black version.

#### SPECIFICATION:

Dimensions	Ø 49.9 mm
Height	13 mm
Fastening	socket
ROHS compliant	yes ⓘ



#### MATERIALS:

Component	Type	Material	Colour	Finish
AMY-50-S	Single lens	PMMA		
AMY-50-HLD-C	Holder	PC	black	





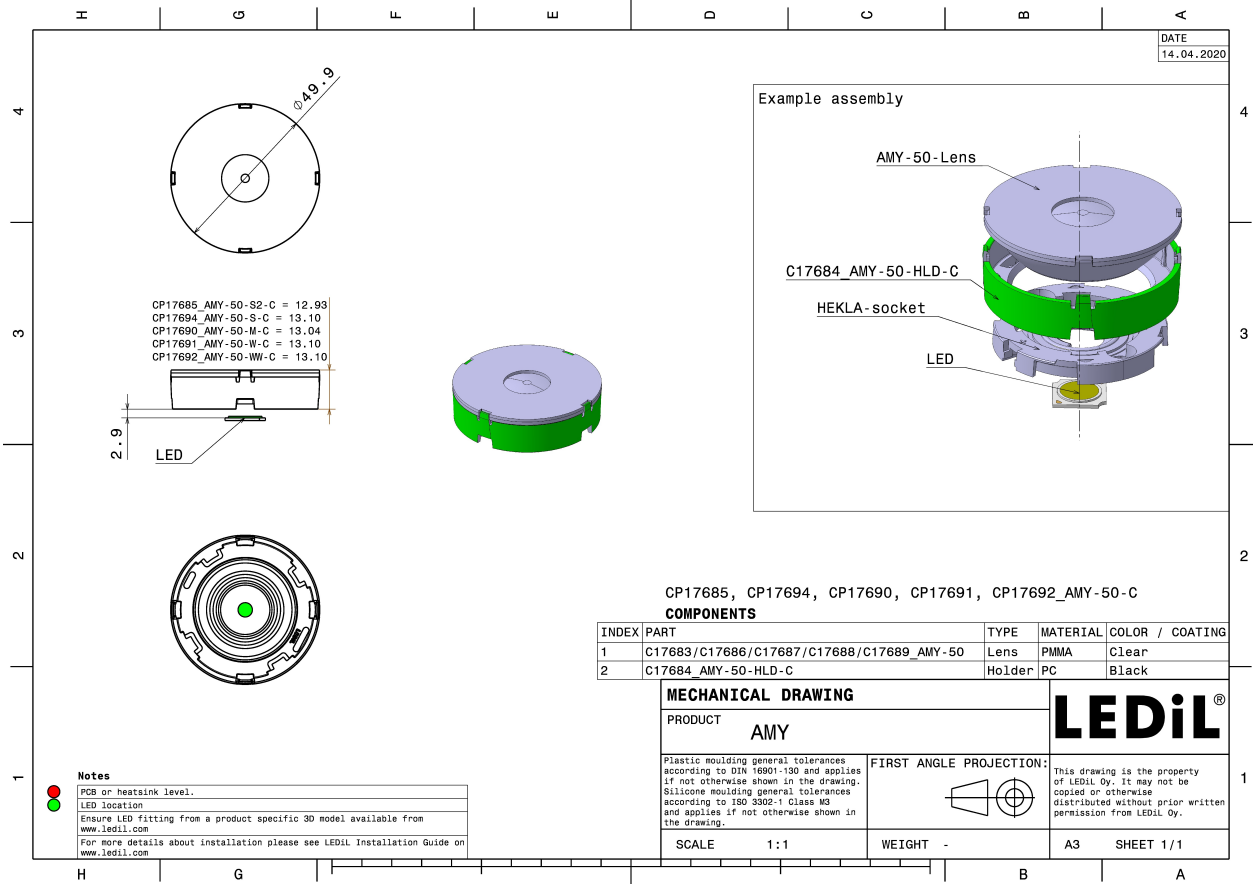



#### ORDERING INFORMATION:

Component	Qty in box	MOQ	MPQ	Box weight (kg)
CP17694_AMY-50-S-C » Box size: 480 x 280 x 300 mm	510	120	30	9.1

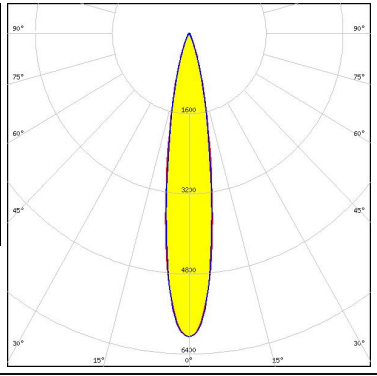

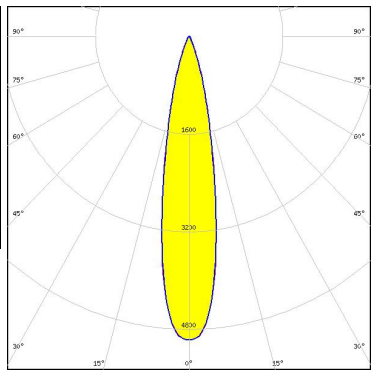

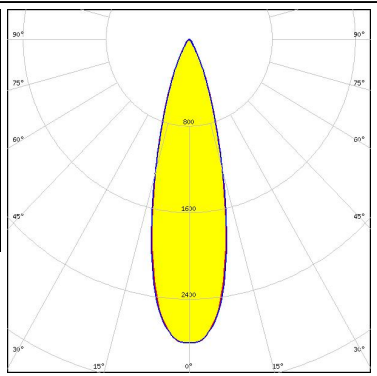

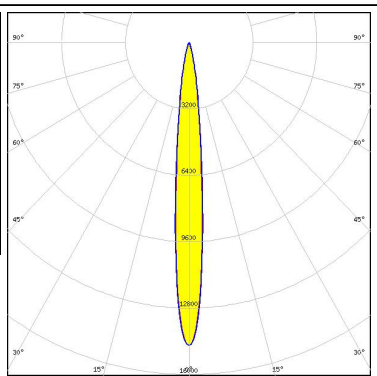



See also our general installation guide: [www.ledil.com/installation\\_guide](http://www.ledil.com/installation_guide)

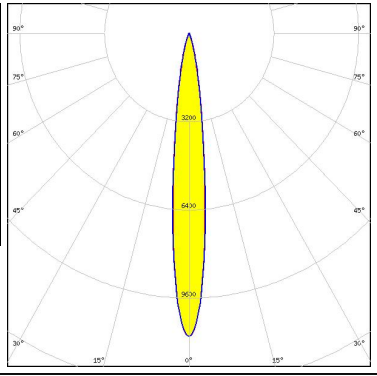

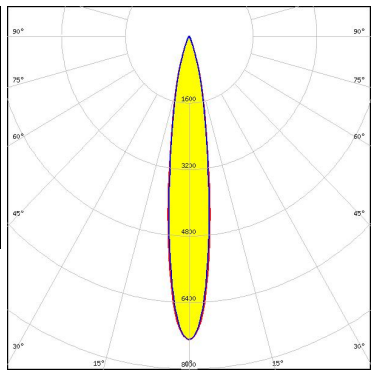

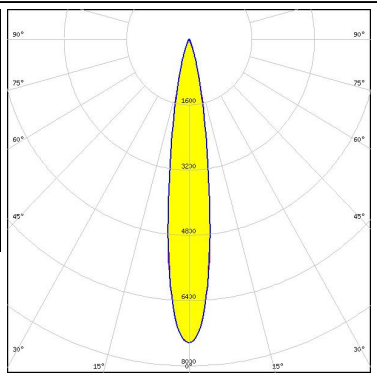

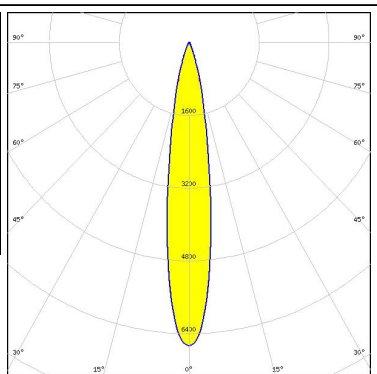

#### OPTICAL RESULTS (MEASURED):

<p></p> <p>LED V10 Gen 8            FWHM / FWTM 18.0° / 38.0°            Efficiency 91 %            Peak intensity 6.1 cd/lm            LEDs/each optic 1            Light colour White            Required components:            F15255_HEKLA-SOCKET-C</p>		
<p></p> <p>LED V11 HD Gen 8            FWHM / FWTM 20.0° / 41.0°            Efficiency 90 %            Peak intensity 5 cd/lm            LEDs/each optic 1            Light colour White            Required components:            Bender Wirth: 633d Hekla</p>		
<p></p> <p>LED V13 Gen 8            FWHM / FWTM 28.0° / 53.0°            Efficiency 87 %            Peak intensity 2.8 cd/lm            LEDs/each optic 1            Light colour White            Required components:            F15859_HEKLA-SOCKET-I</p>		
<p></p> <p>LED V4 HD Gen 7            FWHM / FWTM 10.0° / 24.0°            Efficiency 93 %            Peak intensity 14.6 cd/lm            LEDs/each optic 1            Light colour White            Required components:            F15253_HEKLA-SOCKET-A</p>		

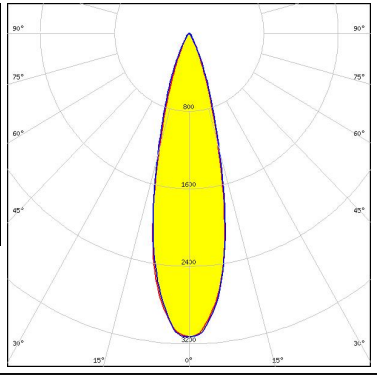

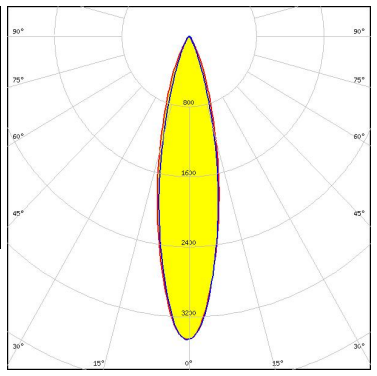

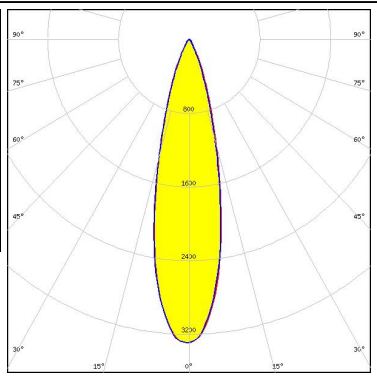

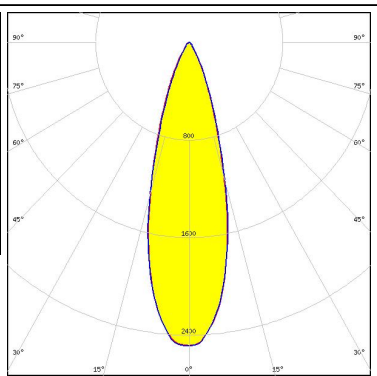

#### OPTICAL RESULTS (MEASURED):

<p></p> <p>LED V6 HD Gen 7</p> <p>FWHM / FWTM 12.0° / 28.0°</p> <p>Efficiency 92 %</p> <p>Peak intensity 11 cd/lm</p> <p>LEDs/each optic 1</p> <p>Light colour White</p> <p>Required components: F15255_HEKLA-SOCKET-C</p>		
<p></p> <p>LED V8 Gen 8</p> <p>FWHM / FWTM 16.0° / 35.0°</p> <p>Efficiency 92 %</p> <p>Peak intensity 7.3 cd/lm</p> <p>LEDs/each optic 1</p> <p>Light colour White</p> <p>Required components: F15253_HEKLA-SOCKET-A</p>		
<p></p> <p>LED V9 HD Gen7</p> <p>FWHM / FWTM 16.0° / 33.0°</p> <p>Efficiency 90 %</p> <p>Peak intensity 7.4 cd/lm</p> <p>LEDs/each optic 1</p> <p>Light colour White</p> <p>Required components: F15859_HEKLA-SOCKET-I</p>		
<p></p> <p>LED VERO10</p> <p>FWHM / FWTM 17.0° / 36.0°</p> <p>Efficiency 90 %</p> <p>Peak intensity 6.7 cd/lm</p> <p>LEDs/each optic 1</p> <p>Light colour White</p> <p>Required components: F15616_HEKLA-SOCKET-F</p>		

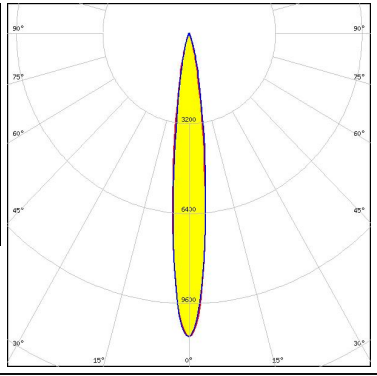
#### OPTICAL RESULTS (MEASURED):

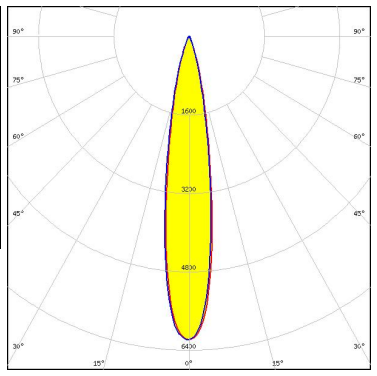
<p></p> <p>LED Vesta DTW 13mm (21W)            FWHM / FWTM 27.0° / 49.0°            Efficiency 86 %            Peak intensity 3.1 cd/m            LEDs/each optic 1            Light colour White            Required components:            C16142_HEKLA-SOCKET-K            Bender Wirth: 491 Typ L8</p>		
<p></p> <p>LED Vesta DTW 15mm (33W)            FWHM / FWTM 24.0° / 49.0°            Efficiency 86 %            Peak intensity 3.5 cd/m            LEDs/each optic 1            Light colour White            Required components:            C16142_HEKLA-SOCKET-K            Bender Wirth: 491 Typ L8</p>		
<p></p> <p>LED Vesta TW 13mm (18W) DP            FWHM / FWTM 25.0° / 49.0°            Efficiency 86 %            Peak intensity 3.3 cd/m            LEDs/each optic 1            Light colour Tunable White            Required components:            C16142_HEKLA-SOCKET-K            Bender Wirth: 492 Typ L8</p>		
<p></p> <p>LED Vesta TW 15mm DP            FWHM / FWTM 30.0° / 55.0°            Efficiency 85 %            Peak intensity 2.5 cd/m            LEDs/each optic 1            Light colour Tunable White            Required components:            C16142_HEKLA-SOCKET-K            Bender Wirth: 482 Typ L8</p>		

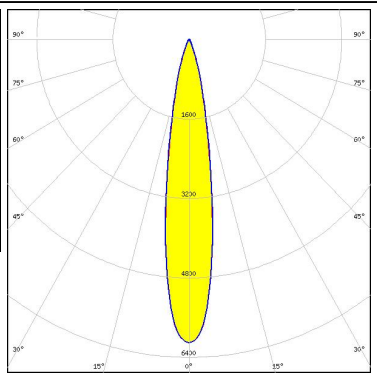
#### OPTICAL RESULTS (MEASURED):

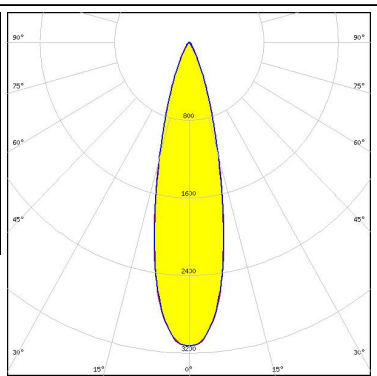
<p></p> <p>LED Vesta TW 6mm DP            FWHM / FWTM 13.0° / 28.0°            Efficiency 90 %            Peak intensity 10.8 cd/lm            LEDs/each optic 1            Light colour Tunable White            Required components:            C16142_HEKLA-SOCKET-K            Bender Wirth: 504 Typ L8</p>		
<p></p> <p>LED Vesta TW 9mm (9W) DP            FWHM / FWTM 18.0° / 36.0°            Efficiency 88 %            Peak intensity 6.2 cd/lm            LEDs/each optic 1            Light colour Tunable White            Required components:            C16142_HEKLA-SOCKET-K            Bender Wirth: 489 Typ L8</p>		
<p><b>CITIZEN</b></p> <p>LED CLL02x/CLU02x (LES10)            FWHM / FWTM 18.0° / 36.0°            Efficiency 89 %            Peak intensity 6.1 cd/lm            LEDs/each optic 1            Light colour White            Required components:            F17435_HEKLA-G2-C</p>		
<p><b>CITIZEN</b></p> <p>LED CLL03x/CLU03x            FWHM / FWTM 26.0° / 50.0°            Efficiency 86 %            Peak intensity 3.1 cd/lm            LEDs/each optic 1            Light colour White            Required components:            F17438_HEKLA-G2-I</p>		

#### OPTICAL RESULTS (MEASURED):

### CITIZEN

LED CLU700/701/702/703  
 FWHM / FWTM 13.0° / 28.0°  
 Efficiency 90 %  
 Peak intensity 11.2 cd/lm  
 LEDs/each optic 1  
 Light colour White  
 Required components:  
 F17435\_HEKLA-G2-C

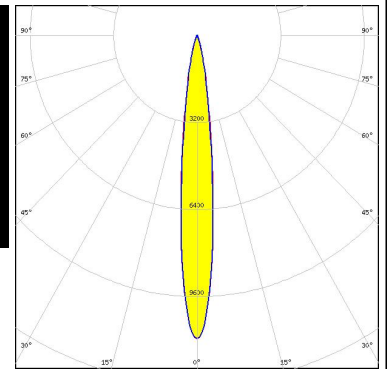
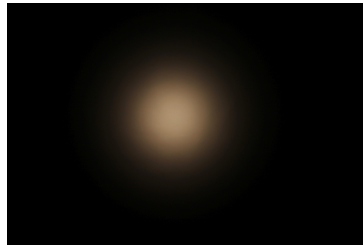

### CITIZEN

LED CLU7A2/7A3  
 FWHM / FWTM 10.0° / 23.0°  
 Efficiency 91 %  
 Peak intensity 15.3 cd/lm  
 LEDs/each optic 1  
 Light colour White  
 Required components:  
 F17435\_HEKLA-G2-C

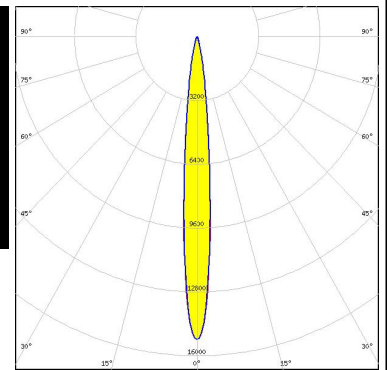
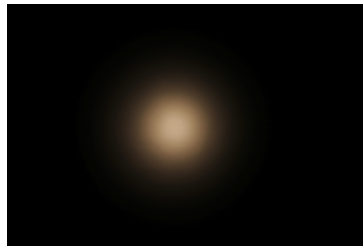

### CITIZEN

LED CLU7B2  
 FWHM / FWTM 9.0° / 22.0°  
 Efficiency 91 %  
 Peak intensity 18.2 cd/lm  
 LEDs/each optic 1  
 Light colour White  
 Required components:  
 F17435\_HEKLA-G2-C

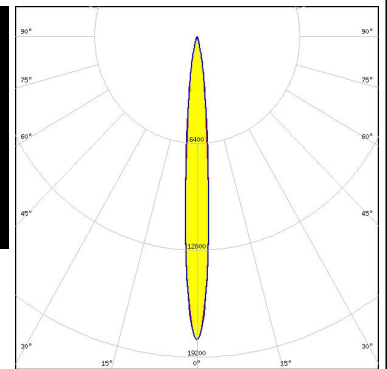
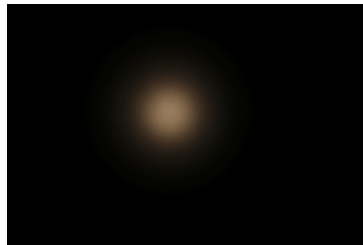





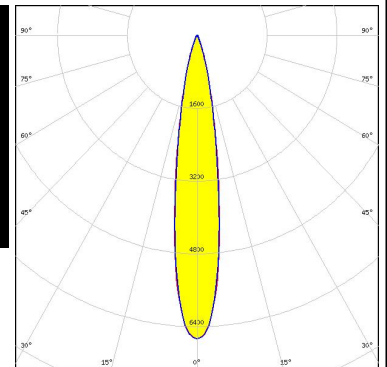
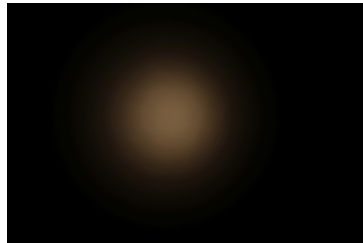

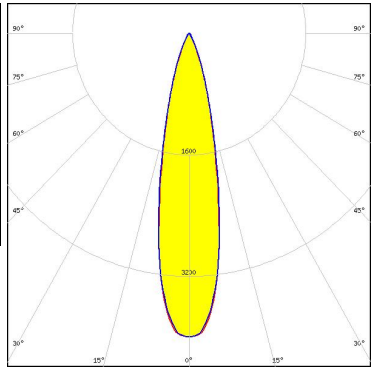

### CREE LED

LED CMA1516  
 FWHM / FWTM 17.0° / 35.0°  
 Efficiency 90 %  
 Peak intensity 6.7 cd/lm  
 LEDs/each optic 1  
 Light colour White  
 Required components:  
 F17436\_HEKLA-G2-D

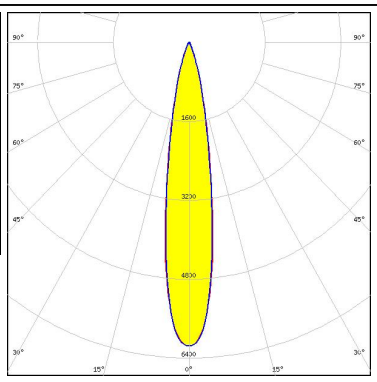

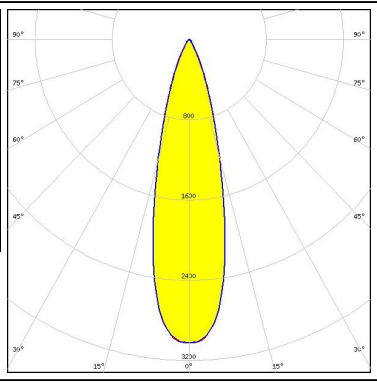

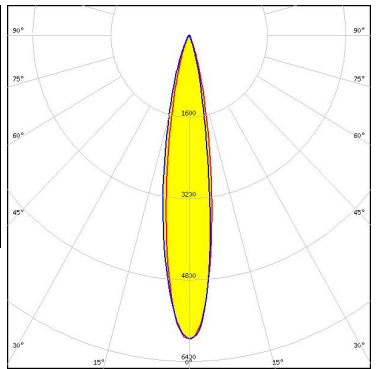



#### OPTICAL RESULTS (MEASURED):

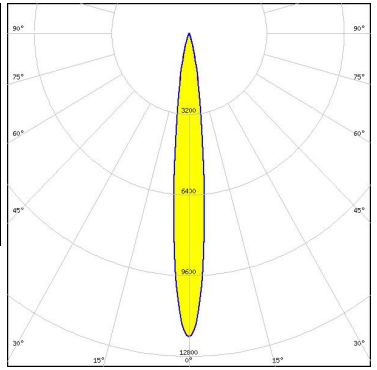

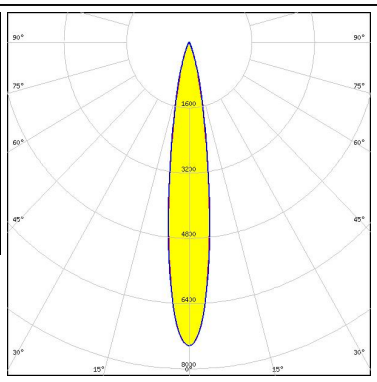

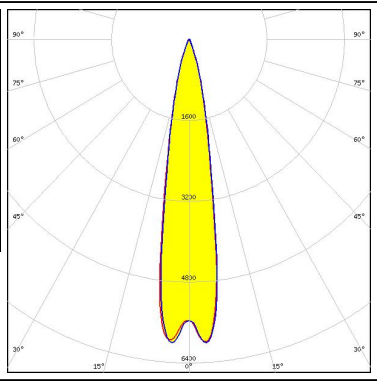

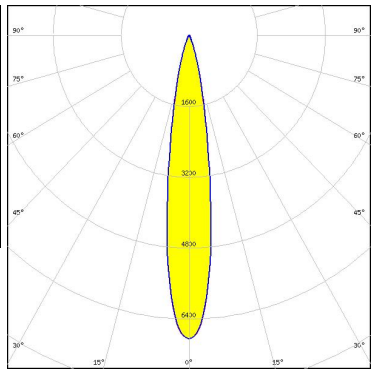
<p><b>CREE</b>  <b>LED</b></p> <p>LED CMA1825            FWHM / FWTM 23.0° / 45.0°            Efficiency 89 %            Peak intensity 4 cd/lm            LEDs/each optic 1            Light colour White            Required components:            F15254_HEKLA-SOCKET-B</p>		
<p><b>CREE</b>  <b>LED</b></p> <p>LED CMT14xx            FWHM / FWTM 18.0° / 37.0°            Efficiency 89 %            Peak intensity 6.2 cd/lm            LEDs/each optic 1            Light colour White            Required components:            F17435_HEKLA-G2-C</p>		
<p><b>CREE</b>  <b>LED</b></p> <p>LED CMT19xx            FWHM / FWTM 26.0° / 51.0°            Efficiency 87 %            Peak intensity 3 cd/lm            LEDs/each optic 1            Light colour White            Required components:            F17438_HEKLA-G2-I</p>		
<p><b>CREE</b>  <b>LED</b></p> <p>LED CMU10xx            FWHM / FWTM 18.0° / 37.0°            Efficiency 89 %            Peak intensity 6 cd/lm            LEDs/each optic 1            Light colour White            Required components:            F17435_HEKLA-G2-C</p>		



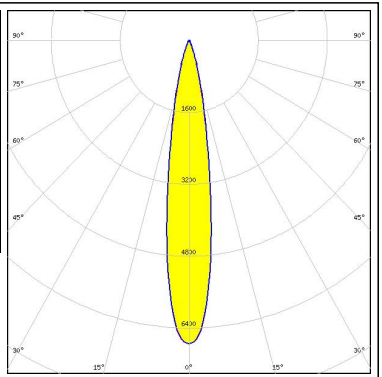

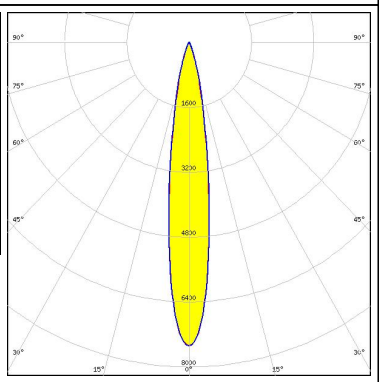
#### OPTICAL RESULTS (MEASURED):

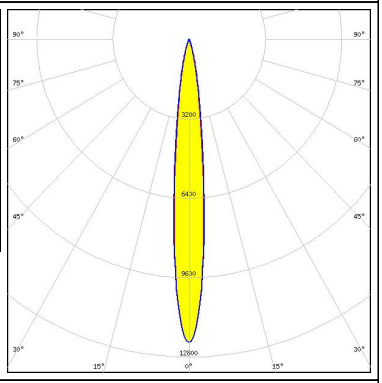
<p><b>CREE</b> LED</p> <p>LED CXA/B 13xx            FWHM / FWTM 12.0° / 27.0°            Efficiency 92 %            Peak intensity 12 cd/lm            LEDs/each optic 1            Light colour White            Required components:            F17439_HEKLA-G2-J</p>		
<p><b>CREE</b> LED</p> <p>LED CXA/B 15xx            FWHM / FWTM 15.0° / 34.0°            Efficiency 90 %            Peak intensity 7.4 cd/lm            LEDs/each optic 1            Light colour White            Required components:            F17436_HEKLA-G2-D</p>		
<p><b>LEDIM</b></p> <p>LED LEDIM/C6            FWHM / FWTM 19.0° / 37.0°            Efficiency 90 %            Peak intensity 6.2 cd/lm            LEDs/each optic 9            Light colour White            Required components:            F17438_HEKLA-G2-I</p>		
<p><b>LUMILEDS</b></p> <p>LED LUXEON CoB 1202/1203            FWHM / FWTM 17.0° / 35.0°            Efficiency 89 %            Peak intensity 6.9 cd/lm            LEDs/each optic 1            Light colour White            Required components:            F17437_HEKLA-G2-H</p>		

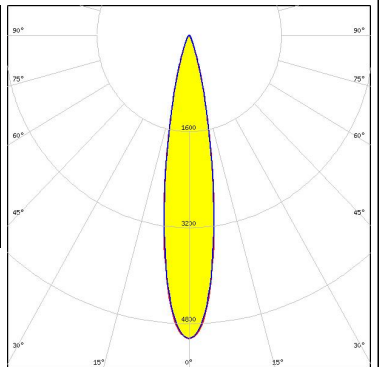



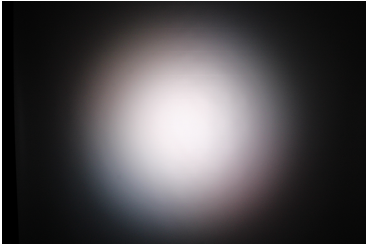
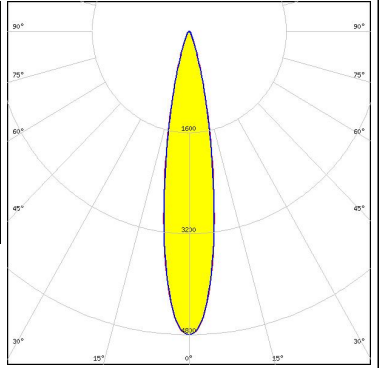

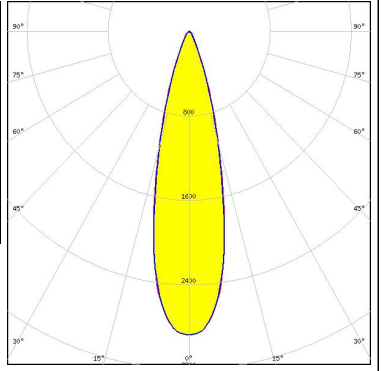
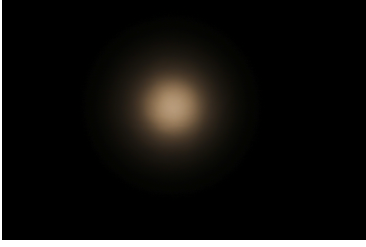
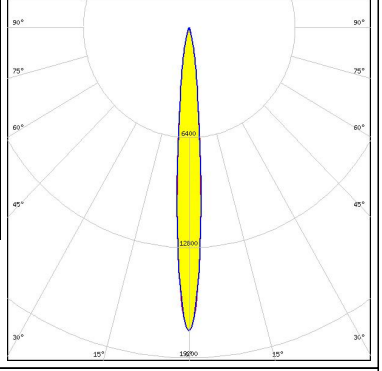
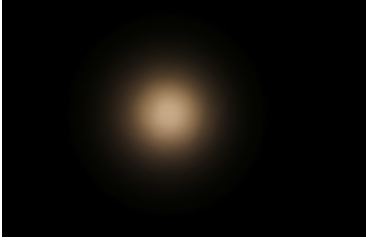
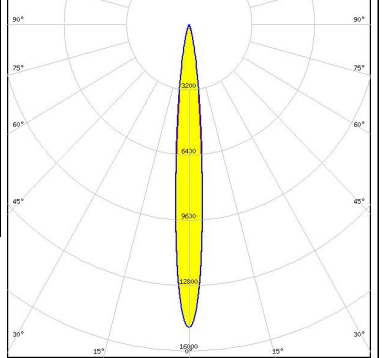
#### OPTICAL RESULTS (MEASURED):

<p><b>LUMILEDS</b></p> <p>LED LUXEON CoB 1204HD</p> <p>FWHM / FWTM 17.0° / 35.0°</p> <p>Efficiency 89 %</p> <p>Peak intensity 6.8 cd/lm</p> <p>LEDs/each optic 1</p> <p>Light colour White</p> <p>Required components: F17437_HEKLA-G2-H</p>		
<p><b>LUMILEDS</b></p> <p>LED LUXEON CoB M02/M03</p> <p>FWHM / FWTM 16.0° / 34.0°</p> <p>Efficiency 90 %</p> <p>Peak intensity 7.5 cd/lm</p> <p>LEDs/each optic 1</p> <p>Light colour White</p> <p>Required components: F17436_HEKLA-G2-D</p>		
<p><b>LUMILEDS</b></p> <p>LED LUXEON CoB S01</p> <p>FWHM / FWTM 12.0° / 27.0°</p> <p>Efficiency 91 %</p> <p>Peak intensity 12.2 cd/lm</p> <p>LEDs/each optic 1</p> <p>Light colour White</p> <p>Required components: F17439_HEKLA-G2-J</p>		
<p><b>LUMILEDS</b></p> <p>LED LUXEON Fusion 12-up (20x24)</p> <p>FWHM / FWTM 19.0° / 38.0°</p> <p>Efficiency 83 %</p> <p>Peak intensity 5.1 cd/lm</p> <p>LEDs/each optic 12</p> <p>Light colour White</p> <p>Required components: C16142_HEKLA-SOCKET-K F18158_HEKLA-RZ-LENS Bender Wirth: 442 Typ L8</p>		

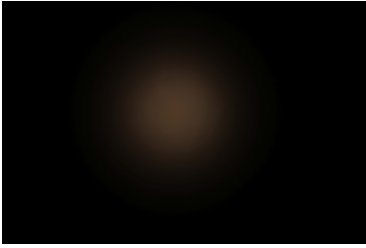
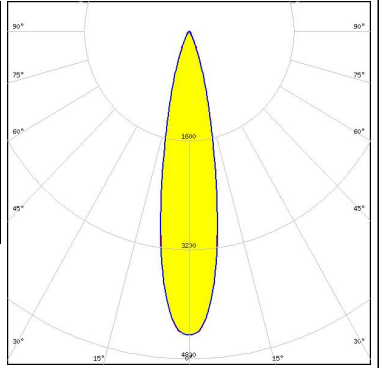
#### OPTICAL RESULTS (MEASURED):

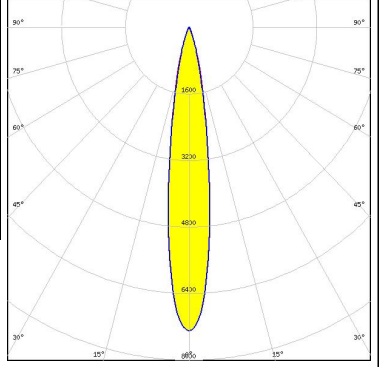
<p><b>LUMILEDS</b></p> <p>LED LUXEON Fusion 21-up (20x24)</p> <p>FWHM / FWTM 19.0° / 38.0°</p> <p>Efficiency 81 %</p> <p>Peak intensity 4.8 cd/lm</p> <p>LEDs/each optic 21</p> <p>Light colour White</p> <p>Required components: C16142_HEKLA-SOCKET-K F18158_HEKLA-RZ-LENS Bender Wirth: 442 Typ L8</p>		
<p><b>LUMILEDS</b></p> <p>LED LUXEON Fusion 27-up (20x24)</p> <p>FWHM / FWTM 26.0° / 48.0°</p> <p>Efficiency 80 %</p> <p>Peak intensity 2.9 cd/lm</p> <p>LEDs/each optic 27</p> <p>Light colour White</p> <p>Required components: C16142_HEKLA-SOCKET-K F18158_HEKLA-RZ-LENS Bender Wirth: 442 Typ L8</p>		
<p><b>LUMINUS</b></p> <p>LED CXM-3</p> <p>FWHM / FWTM 10.0° / 22.0°</p> <p>Efficiency 91 %</p> <p>Peak intensity 17.7 cd/lm</p> <p>LEDs/each optic 1</p> <p>Light colour White</p> <p>Required components: F17435_HEKLA-G2-C</p>		
<p><b>LUMINUS</b></p> <p>LED CXM-4</p> <p>FWHM / FWTM 10.0° / 24.0°</p> <p>Efficiency 91 %</p> <p>Peak intensity 14.9 cd/lm</p> <p>LEDs/each optic 1</p> <p>Light colour White</p> <p>Required components: F17435_HEKLA-G2-C</p>		

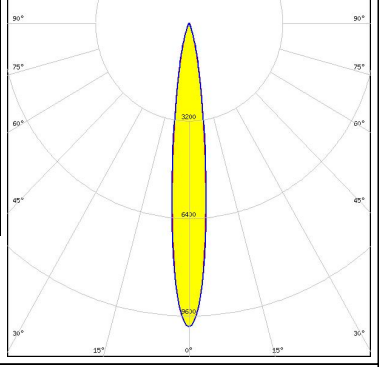
#### OPTICAL RESULTS (MEASURED):

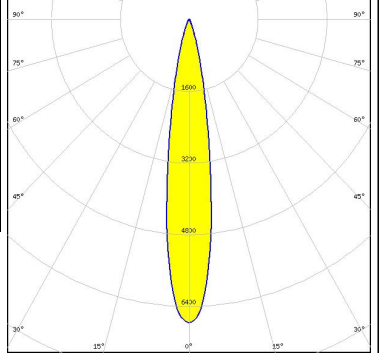
<p><b>NICHIA</b></p> <p>LED COB L-Type (LES 11)</p> <p>FWHM / FWTM 22.0° / 43.0°</p> <p>Efficiency 88 %</p> <p>Peak intensity 4.4 cd/lm</p> <p>LEDs/each optic 1</p> <p>Light colour White</p> <p>Required components: F17437_HEKLA-G2-H</p>		
<p><b>NICHIA</b></p> <p>LED COB L-Type (LES 9)</p> <p>FWHM / FWTM 16.0° / 34.0°</p> <p>Efficiency 89 %</p> <p>Peak intensity 7.3 cd/lm</p> <p>LEDs/each optic 1</p> <p>Light colour White</p> <p>Required components: F17437_HEKLA-G2-H</p>		
<p><b>NICHIA</b></p> <p>LED COB S-Type (LES 7)</p> <p>FWHM / FWTM 13.0° / 29.0°</p> <p>Efficiency 91 %</p> <p>Peak intensity 10 cd/lm</p> <p>LEDs/each optic 1</p> <p>Light colour White</p> <p>Required components: F17437_HEKLA-G2-H</p>		
<p><b>PHILIPS</b></p> <p>LED Fortimo SLM L09 CoB</p> <p>FWHM / FWTM 17.0° / 35.0°</p> <p>Efficiency 89 %</p> <p>Peak intensity 6.8 cd/lm</p> <p>LEDs/each optic 1</p> <p>Light colour White</p> <p>Required components: F17437_HEKLA-G2-H</p>		

#### OPTICAL RESULTS (MEASURED):

### SAMSUNG

LED LC003D / LC006D / LC009D / LC013D  
 FWHM / FWTM 17.0° / 36.0°  
 Efficiency 89 %  
 Peak intensity 6.3 cd/m  
 LEDs/each optic 1  
 Light colour White  
 Required components:  
 F17435\_HEKLA-G2-C

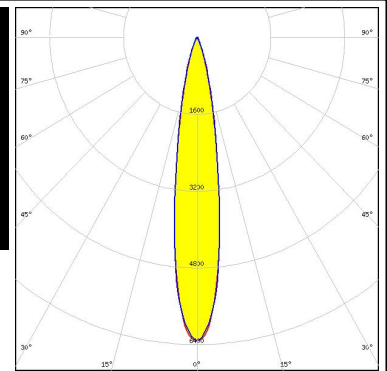
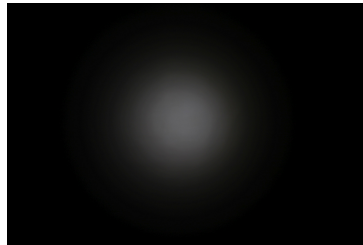

### SAMSUNG

LED LC016D / LC019D / LC026D / LC033D  
 FWHM / FWTM 28.0° / 55.0°  
 Efficiency 86 %  
 Peak intensity 2.7 cd/m  
 LEDs/each optic 1  
 Light colour White  
 Required components:  
 F17438\_HEKLA-G2-I

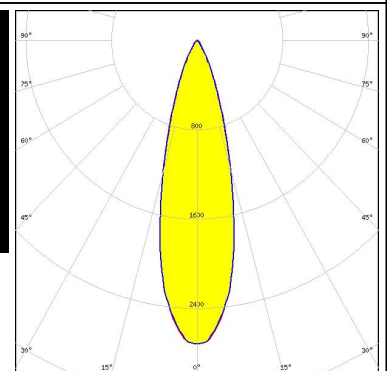
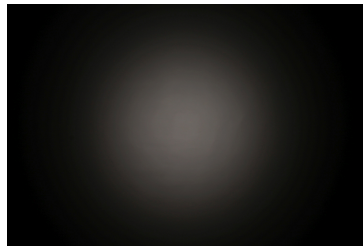

### SAMSUNG

LED LC030C/040C G2  
 FWHM / FWTM 21.0° / 42.0°  
 Efficiency 88 %  
 Peak intensity 4.5 cd/m  
 LEDs/each optic 1  
 Light colour White  
 Required components:  
 F17438\_HEKLA-G2-I

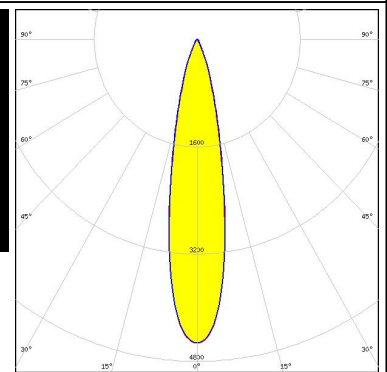
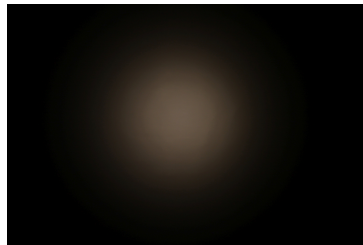





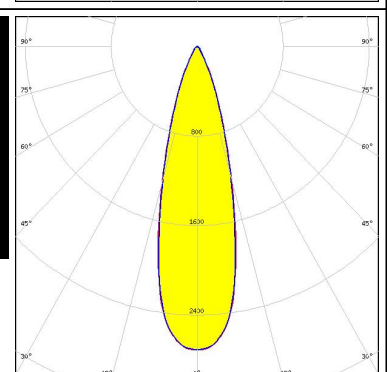
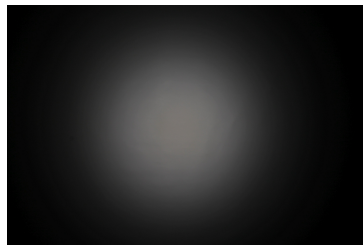

SEOUL SEMICONDUCTOR

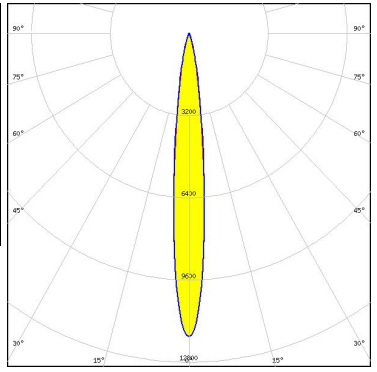
LED MJT COB LES 14.5  
 FWHM / FWTM 28.0° / 53.0°  
 Efficiency 86 %  
 Peak intensity 2.7 cd/m  
 LEDs/each optic 1  
 Light colour White  
 Required components:  
 F17438\_HEKLA-G2-I

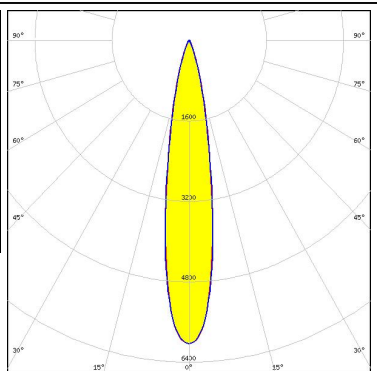

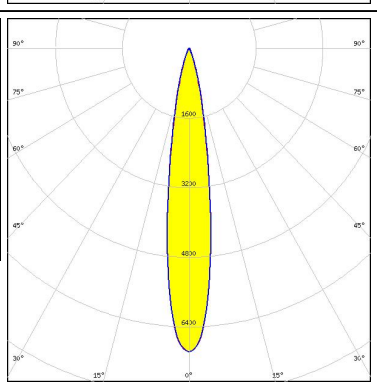
#### OPTICAL RESULTS (MEASURED):

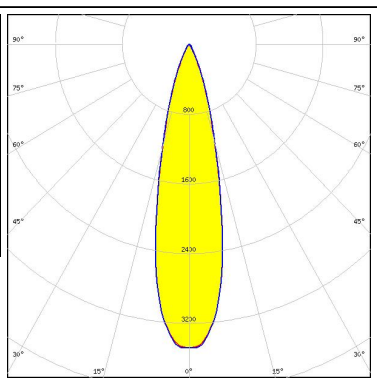
<p><b>SEOL</b> SEOL SEMICONDUCTOR</p> <p>LED MJT COB LES 6 FWHM / FWTM 12.0° / 27.0° Efficiency 91 % Peak intensity 11.9 cd/lm LEDs/each optic 1 Light colour White Required components: F17435_HEKLA-G2-C</p>		
<p><b>SEOL</b> SEOL SEMICONDUCTOR</p> <p>LED MJT COB LES 9.8 FWHM / FWTM 18.0° / 37.0° Efficiency 89 % Peak intensity 6 cd/lm LEDs/each optic 1 Light colour White Required components: F17435_HEKLA-G2-C</p>		
<p><b>TRIDONIC</b></p> <p>LED SLE G7 LES09 FWHM / FWTM 16.0° / 34.0° Efficiency 89 % Peak intensity 7 cd/lm LEDs/each optic 1 Light colour White Required components: F15848_HEKLA-SOCKET-G</p>		
<p><b>TRIDONIC</b></p> <p>LED SLE G7 LES13 FWHM / FWTM 25.0° / 48.0° Efficiency 87 % Peak intensity 3.5 cd/lm LEDs/each optic 1 Light colour White Required components: F17438_HEKLA-G2-I</p>		



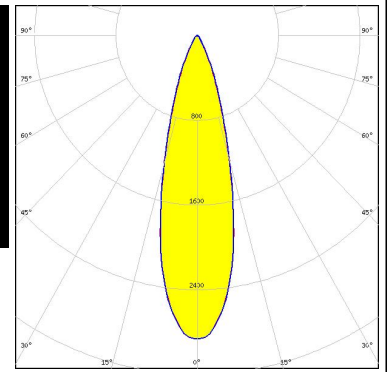

## OPTICAL RESULTS (MEASURED):

### TRIDONIC

LED SLE G7 LES15  
FWHM / FWTM 27.0° / 53.0°  
Efficiency 86 %  
Peak intensity 2.9 cd/lm  
LEDs/each optic 1  
Light colour White  
Required components:  
F17438\_HEKLA-G2-I

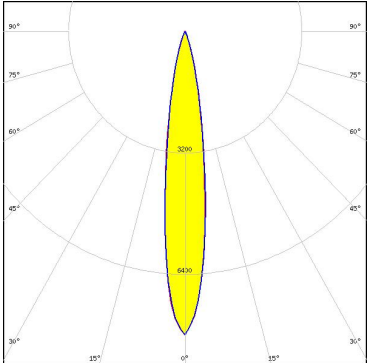

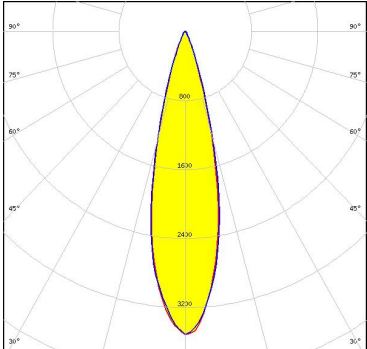
#### OPTICAL RESULTS (SIMULATED):

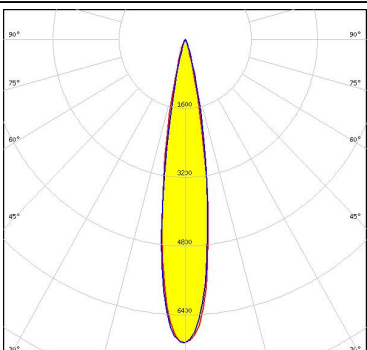
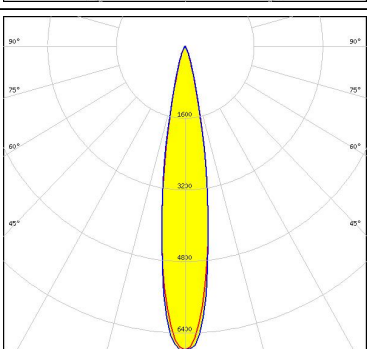
<p></p> <p>LED V8 Gen7</p> <p>FWHM / FWTM 16.0° / 34.0°</p> <p>Efficiency 89 %</p> <p>Peak intensity 8 cd/lm</p> <p>LEDs/each optic 1</p> <p>Light colour White</p> <p>Required components: F15253_HEKLA-SOCKET-A</p>	
<p></p> <p>LED Vero SE 13</p> <p>FWHM / FWTM 26.0° / 44.0°</p> <p>Efficiency 81 %</p> <p>Peak intensity 3.5 cd/lm</p> <p>LEDs/each optic 1</p> <p>Light colour White</p> <p>Required components: C16142_HEKLA-SOCKET-K</p>	
<p></p> <p>LED Vesta TW 9mm (12W) CSP</p> <p>FWHM / FWTM 18.1° / 32.2 + 31.2°</p> <p>Efficiency 81 %</p> <p>Peak intensity 7.1 cd/lm</p> <p>LEDs/each optic 1</p> <p>Light colour White</p> <p>Required components: C16142_HEKLA-SOCKET-K</p>	
<p><b>CITIZEN</b></p> <p>LED CLL02x/CLU02x (LES10)</p> <p>FWHM / FWTM 18.1° / 33.2 + 34.2°</p> <p>Efficiency 87 %</p> <p>Peak intensity 6.8 cd/lm</p> <p>LEDs/each optic 1</p> <p>Light colour White</p> <p>Required components: F15255_HEKLA-SOCKET-C</p>	



#### OPTICAL RESULTS (SIMULATED):

#### CITIZEN

LED CLU700/701/702/703  
 FWHM / FWTM 11.3° / 22.1°  
 Efficiency 91 %  
 Peak intensity 15 cd/lm  
 LEDs/each optic 1  
 Light colour White  
 Required components:  
 F15255\_HEKLA-SOCKET-C

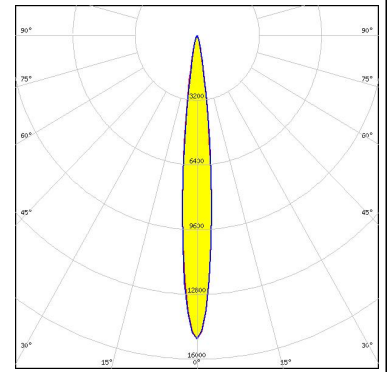

#### CITIZEN

LED CLU710/711  
 FWHM / FWTM 16.1° / 30.2°  
 Efficiency 89 %  
 Peak intensity 8.7 cd/lm  
 LEDs/each optic 1  
 Light colour White  
 Required components:  
 F15859\_HEKLA-SOCKET-I

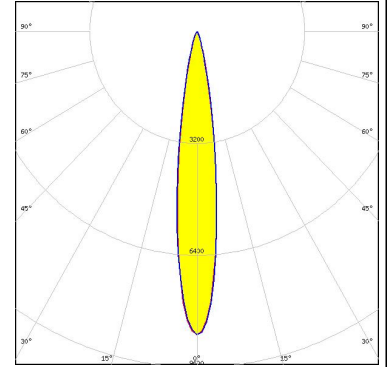

#### CITIZEN

LED CLU712/713  
 FWHM / FWTM 16.0° / 34.0°  
 Efficiency 90 %  
 Peak intensity 8.1 cd/lm  
 LEDs/each optic 1  
 Light colour White  
 Required components:  
 F17438\_HEKLA-G2-I

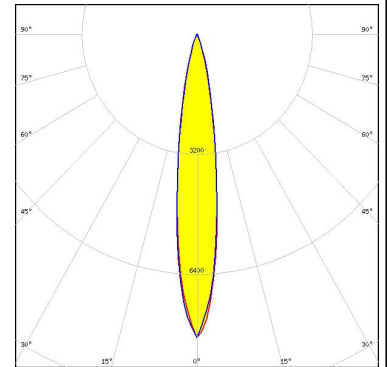

#### CREE LED

LED CHA0304  
 FWHM / FWTM 10.0° / 22.0°  
 Efficiency 91 %  
 Peak intensity 17.5 cd/lm  
 LEDs/each optic 1  
 Light colour White  
 Required components:  
 F17435\_HEKLA-G2-C

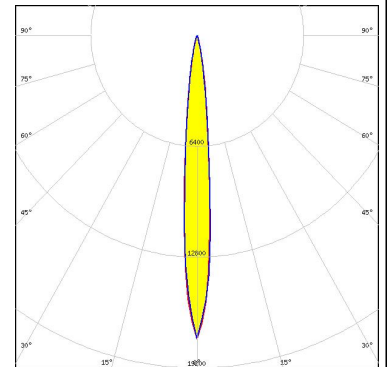

#### OPTICAL RESULTS (SIMULATED):



LED: CHA0612  
 FWHM / FWTM: 12.0° / 28.0°  
 Efficiency: 91 %  
 Peak intensity: 11.8 cd/lm  
 LEDs/each optic: 1  
 Light colour: White  
 Required components:  
 F17435\_HEKLA-G2-C

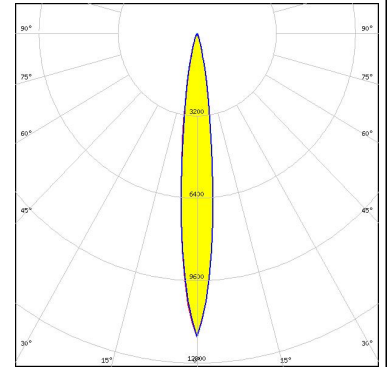

LED: CHA0825  
 FWHM / FWTM: 16.0° / 34.0°  
 Efficiency: 90 %  
 Peak intensity: 7.6 cd/lm  
 LEDs/each optic: 1  
 Light colour: White  
 Required components:  
 F17438\_HEKLA-G2-I

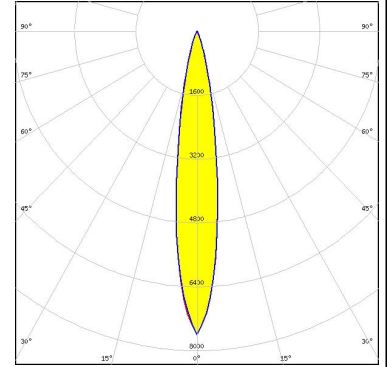

LED: CMA1306  
 FWHM / FWTM: 12.0° / 26.0°  
 Efficiency: 94 %  
 Peak intensity: 13.5 cd/lm  
 LEDs/each optic: 1  
 Light colour: White  
 Required components:  
 F15956\_HEKLA-SOCKET-J

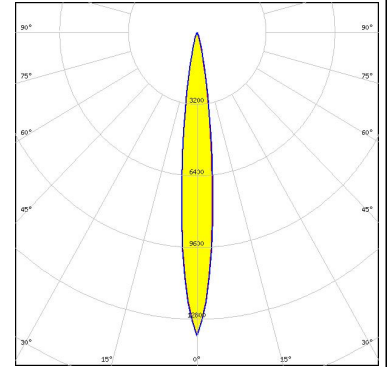

LED: LUXEON CoB 1202/1203  
 FWHM / FWTM: 16.1° / 30.2°  
 Efficiency: 88 %  
 Peak intensity: 8.2 cd/lm  
 LEDs/each optic: 1  
 Light colour: White  
 Required components:  
 F15858\_HEKLA-SOCKET-H

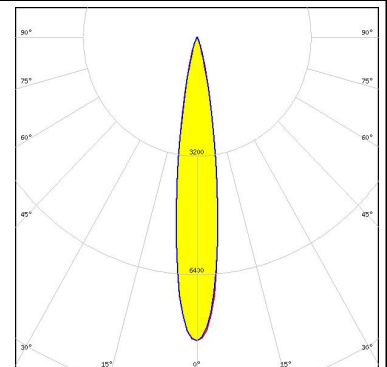

#### OPTICAL RESULTS (SIMULATED):



LED COB S-Type (LES 7)  
Assembly NULL  
FWHM / FWTM 14.0° / 30.0°  
Efficiency 89 %  
Peak intensity 10.2 cd/lm  
LEDs/each optic 1  
Light colour White  
Required components:  
Bender Wirth: 652a Hekla

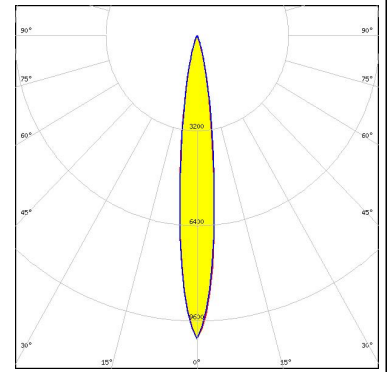

#### SAMSUNG

LED LC003D / LC006D / LC009D / LC013D  
FWHM / FWTM 16.1° / 32.2°  
Efficiency 87 %  
Peak intensity 7.4 cd/lm  
LEDs/each optic 1  
Light colour White  
Required components:  
F15255\_HEKLA-SOCKET-C

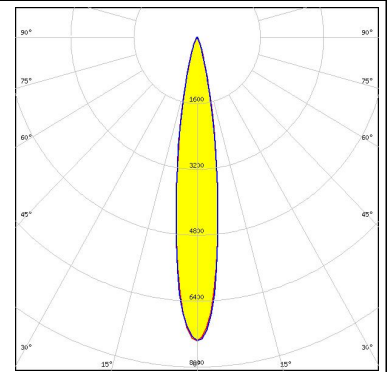

#### TRIDONIC

LED SLE SNC8 LES06  
FWHM / FWTM 12.0° / 28.0°  
Efficiency 93 %  
Peak intensity 12.2 cd/lm  
LEDs/each optic 1  
Light colour White  
Required components:  
F17435\_HEKLA-G2-C

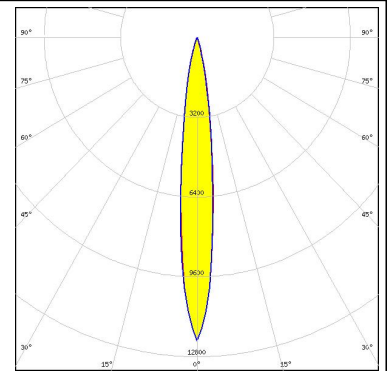

### GENERAL INFORMATION:

NOTE: The typical beam angle will be changed by different color, chip size and chip position tolerance. The typical total beam angle is the full angle measured where the luminous intensity is half of the peak value.

Due to use of high power COB's with this product, special attention to proper thermal design is highly recommended. LEDiL has no liability for direct, indirect or consecutive damages arising from the LEDiL products being used outside of the recommended temperature range.

### MATERIALS:

As part of our continuous research and improvement processes, and to ensure the best possible quality and availability of our products, LEDiL reserves the right to change material grades without notice.

### PRODUCT DATA USER AGREEMENT AND DISCLAIMER:

The measured data in the provided downloadable LEDiL Product Datasheets and Mechanical 2D-Drawings is rounded and provided as reference for planning. LEDiL Oy's optical specifications have been verified by conducting performance testing of the products in accordance with the company's quality system. The reported data are averaged results of multiple measurements with typical variation. LEDiL Oy reserves the right to without prior notification make changes and improvements to its products.

LEDiL Oy assumes neither warranty, nor guarantee nor any other liability of any kind for the contents and correctness of the provided data. The provided data has been generated with highest diligence but the provided data may in reality not represent the complete possible variation range of all intrinsic parameters. Therefore, in certain cases a deviation from the provided data could occur.

LEDiL Oy reserves the right to undertake technical changes of its products without further notification which could lead to changes in the provided data. LEDiL Oy assumes no liability of any kind for the possible deviation from any provided data or any other damage resulting from the usage of the provided data.

The user agrees to this disclaimer and user agreement with the download or usage of the provided files.

#### LEDiL Oy

Joensuunkatu 13  
FI-24240 SALO  
Finland

#### LEDiL Inc.

228 West Page Street  
Suite D  
Sycamore IL 60178  
USA

#### Ledil Optics Technology (Shenzhen) Co., Ltd.

# 405 , Block B  
Casic Motor Building  
Shenzhen 518057  
P.R.CHINA

#### Local sales and technical support

[www.ledil.com/  
where\\_to\\_buy](http://www.ledil.com/where_to_buy)

#### Shipping locations

Salo, Finland  
Hong Kong, China

#### Distribution Partners

[www.ledil.com/  
where\\_to\\_buy](http://www.ledil.com/where_to_buy)