

GP Batteries

PRODUCT SPECIFICATION

USB 4-Slot Charging Dock Model : D451

Revision History

Revision	Date	Initiator	Reason for Change
0.0	31 Mar 2020	CC Li	Initial release

Prepared By CC Li	Approved By Vincent Lam
Date: 31 Mar 2020	Date: 31 Mar 2020

GPI International Limited

7/F, Building 16W, 16 Science Park West Avenue
Hong Kong Science Park, New Territories, Hong Kong,
Tel: (852) 2484 3333 Fax: (852) 24805912
Email: gpii@goldpeak.com
Website: <http://www.gpbatteries.com>

GP Batteries

Product Specification

Model no.: D451

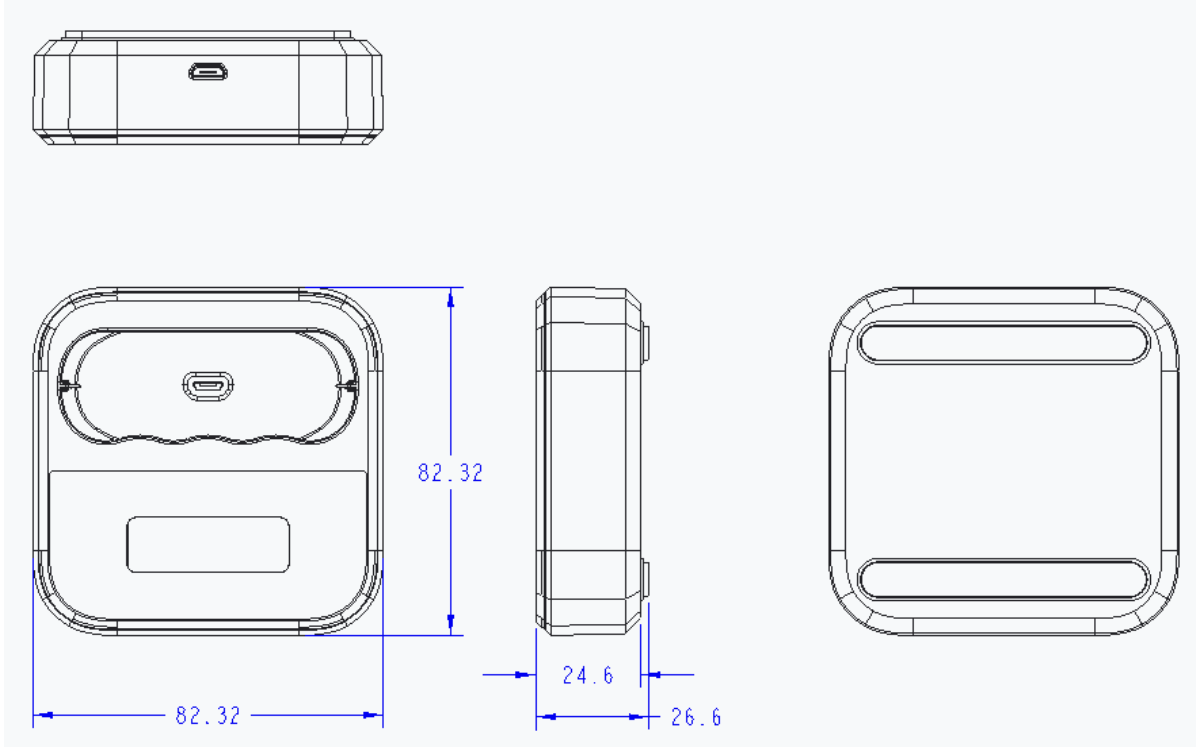

Product Name	:	USB 4-Slot Charging Dock D451
Input	:	DC5V 1A
Applicable Charger	:	1 pcs of USB 4-slot Charger of B421, M451 or P461
Charging Time	:	Same charging time of B421, M451 and P461
Operation Temperature	:	0°C to 35°C
Dimensions	:	82 (L) x 82 (W) x 27 (H) mm
Weight	:	71.5 g (approx.)
Certification	:	CE, FCC, Rohs
Warranty Period	:	12 months from ex-factory date

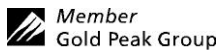



Manufacturer reserves the right to alter or amend the design, model and specification without prior notice.

GP Batteries

Product Specification

Model no.: D451

LCD Indication :

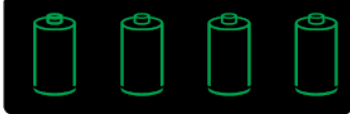
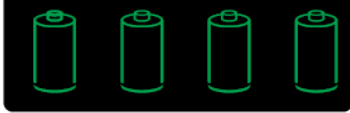
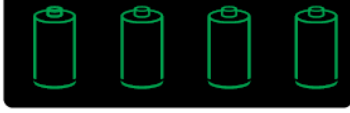
CONDITION	SCREEN DESCRIPTION	LCD STATES
Power on and no charger box inserted	4 Power block turn on	
Charging in progress	Corresponding battery power block flashing	
When charging is finished and then switch to trickle charge	Corresponding battery all power block invariability	
No battery in changer box slot	Corresponding battery icon on	
Changer box plug off	4 Batteries icon flash 10s (f=0.5Hz)	
Bad/ Primary battery inserted	Corresponding battery icon flashing (f=2Hz)	
Ageing battery	Corresponding warning icon turn on and battery power block flashing	