

HRL HIGH RETENTION LOCK SWITCHES

GENERAL ELECTRICAL & MECHANICAL SPECIFICATION

Switch Rating:	1A @ 115Vac
(Switching Resistive load):	1A @ 24Vdc
Life:	>10,000 Cycles
Operating Temperature:	-20°C to +65 °C
Proof Voltage:	750 Vdc (Initial)
Insulation Resistance:	>999 MΩ at 500Vdc (Initial)
Contact Resistance:	<20 mΩ (Initial)
Lock Type:	5 Disc
Std. Qty. of Keys per Lock:	2 Mild Steel Ni Plated
Contact Material:	Brass CZ108 Ag Plated
Moulding Material:	Polyamide 6.6 G.F. V0 Rated
Lock Housing:	Zinc Alloy Bright Cr Plated

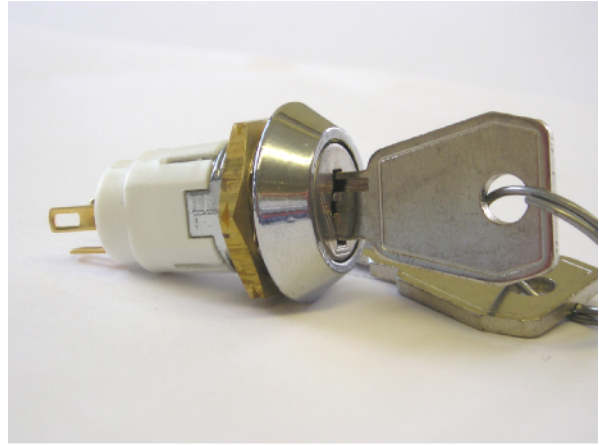

GENERAL FEATURES

- Made in UK.
- Miniature key-operated Lock switch.
- Single or Double pole
- Up to 200 key combinations – keys to differ.
- Common keys available – keys to pass.
- Keys are double entry (they can be inserted into the lock either way up).
- Occupies small panel area.
- Easily assembled through front of equipment panel.
- Rear projection less than 30mm from panel.
- Special high retention module for portable and vehicle applications.

RoHS COMPLIANT

SINGLE POLE LOCK SWITCH

Parallel Lock Head 90° Indexing

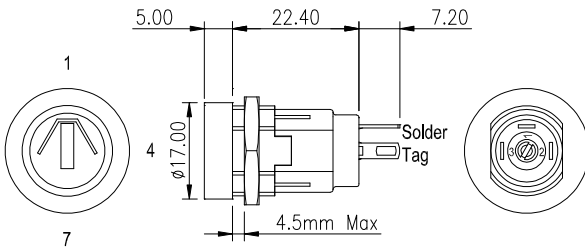

Key Withdrawal Positions

SINGLE POLE LOCK SWITCH

Tapered Lock Head 90° Indexing

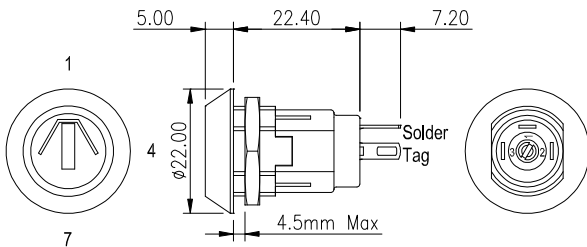

Key Withdrawal Positions

PANEL PIERCING DETAILS

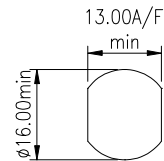

BASIC PART No.	TOTAL MOVEMENT	INDEXING	KEY WITHDRAWAL POSITIONS	SWITCH CONFIGURATION
HRL-5-A	90°	90°	1,4	
HRL-5-B	90°	90°	1 ONLY	
HRL-5-C	180°	90°	1,4,7	
HRL-5-N	180°	90°	1,4,7	

BASIC PART No.	TOTAL MOVEMENT	INDEXING	KEY WITHDRAWAL POSITIONS	SWITCH CONFIGURATION
HRL-5-D	90°	90°	1,4	
HRL-5-E	90°	90°	1 ONLY	
HRL-5-F	180°	90°	1,4,7	
HRL-5-P	180°	90°	1,4,7	

HRL LOCK SWITCHES

DOUBLE POLE LOCK SWITCH

Parallel Lock Head 60° Indexing

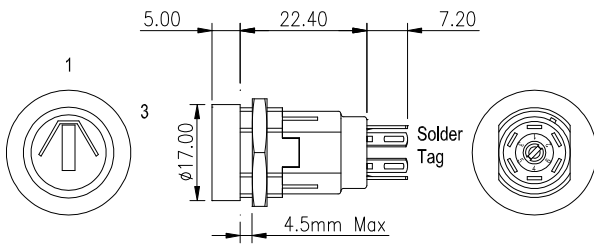

Key Withdrawal Positions

BASIC PART No.	TOTAL MOVEMENT	INDEXING	KEY WITHDRAWAL POSITIONS	SWITCH CONFIGURATION
HRL-5-J	60°	60°	1,3	1—2 3—4
HRL-5-K	60°	60°	1 ONLY	4—5 6—6

DOUBLE POLE LOCK SWITCH

Tapered Lock Head 60° Indexing

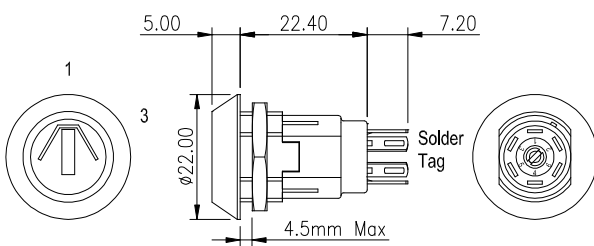

Key Withdrawal Positions

BASIC PART No.	TOTAL MOVEMENT	INDEXING	KEY WITHDRAWAL POSITIONS	SWITCH CONFIGURATION
HRL-5-L	60°	60°	1,3	1—2 3—4
HRL-5-M	60°	60°	1 ONLY	4—5 6—6

OPTIONAL EXTRAS

Moulded Bezel for Parallel Lock Headed Versions

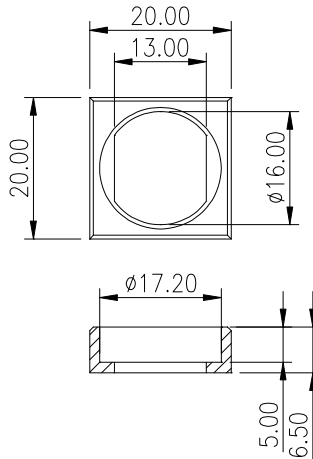

SUPPLIED LOOSE: ORDERING CODE SRL 02101

HRL LOCK SWITCH ORDER CODE

