

# Round LED

## 5mm, Blue

multicomp<sup>PRO</sup>

RoHS  
Compliant



### Features

- 5mm Rounded LED Lamps
- Low power consumption
- Excellent product quality and reliability
- Lead-free device

### Applications

- Electronic signs and signals
- Bright ambient lighting conditions
- Backlight.
- General purpose indicators

Device Selection Guide			
Part No.	Chip		Lens color
MP008538	Material	Emitted color	Water Clear
	InGaN	Blue	

Absolute Maximum Ratings: (T <sub>A</sub> = 25°C)			
Parameter	Symbol	Value	Unit
Power Dissipation	P <sub>D</sub>	120	mW
Forward Current	I <sub>F</sub>	30	mA
Peak Forward Current <sup>*1</sup>	I <sub>FP</sub>	100	mA
Reverse Voltage	V <sub>R</sub>	5	V
Operating Temperature	T <sub>OPR</sub>	-40 to +85	°C
Storage Temperature	T <sub>STG</sub>	-40 to +85	°C
Soldering Temperature <sup>*2</sup>	T <sub>SOI</sub>	260°C For 5 Seconds	

Notes:

\*1: Pulse width ≤ 0.1ms, Duty cycle ≤ 1/10

\*2: Δ At the position of 3mm below package base.

\*3: ▲ Please refer to the curve of forward current vs. temperature

Newark.com/multicomp-pro  
Farnell.com/multicomp-pro  
Element14.com/multicomp-pro

multicomp<sup>PRO</sup>

# Round LED

## 5mm, Blue

Electrical / Optical Characteristics at T <sub>A</sub> = 25°C						
Parameter	Symbol	Min.	Typ.	Max	Unit	Test Conditions
Forward Voltage	V <sub>F</sub>	2.7	3	3.5	V	I <sub>F</sub> =20mA
Reverse Current	I <sub>R</sub>	5	—	—	μA	V <sub>R</sub> =5V
Dominant Wavelength	λ <sub>d</sub>	464	468	474	nm	I <sub>F</sub> =20mA
Peak Wavelength	λ <sub>P</sub>	—	465	—	nm	
Spectral line Half-width	Δλ	—	19	—	nm	
Luminous Intensity	I <sub>v</sub>	—	4000	—	mcd	
Power Angle	2θ <sub>1/2</sub>	—	30	—	Deg.	

**Remarks:**

If special sorting is required (e.g. binning based on forward voltage, luminous intensity, or dominant wavelength), the typical accuracy of the sorting process is as follows:

1. Dominant Wavelength: +/-1nm
2. Chromatic Coordinates: +/-0.01
3. Luminous Intensity: +/-15%
4. Forward Voltage: +/-0.1V

### Dimensions

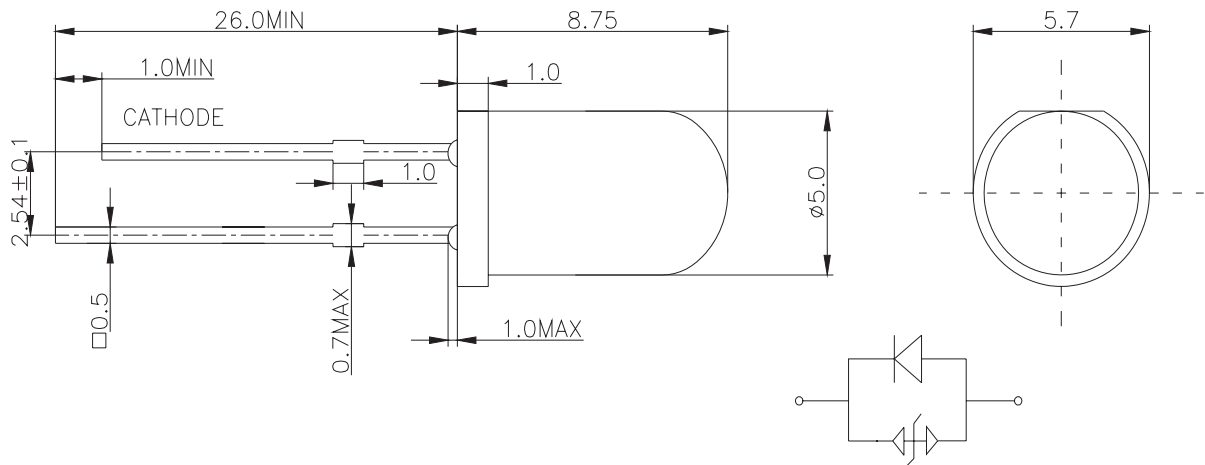

Dimensions : Millimetres

**Notes:**

1. Tolerance is ±0.25 unless otherwise noted.
2. Lead spacing is measured where the leads emerge from the package.
3. Specifications are subject to change without notice.
4. The design and working current for LED is not less than 2mA.

# Round LED

## 5mm, Blue

multicomp **PRO**

### VF Rank

Rank	VF(V)		Condition
	Min	Max	
F1F2	2.7	2.9	IF=20mA
G1G2	2.9	3.1	
H1H2	3.1	3.3	
I1I2	3.3	3.5	

Tolerance :  $\pm 0.1V$

### $\lambda D$ Rank

Rank	$\lambda D$ (nm)		Condition
	Min	Max	
B8	464	466	IF=20mA
B9	466	468	
BA	468	470	
BB	470	472	
BC	472	474	

Tolerance :  $\pm 0.1nm$

### IV Rank

Rank	IV(mcd)		Condition
	Min	Max	
P	2500	3800	IF=20mA
P1	3800	5700	

Tolerance :  $\pm 15\%$

# Round LED

## 5mm, Blue

### Typical Electrical/Optical Characteristics Curves ( Ta=25°C Unless Otherwise Noted )

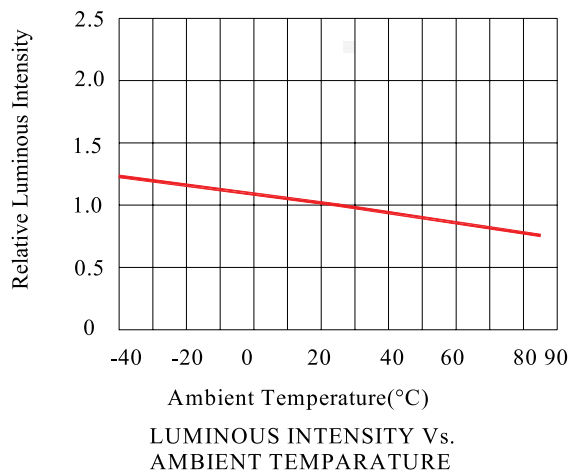
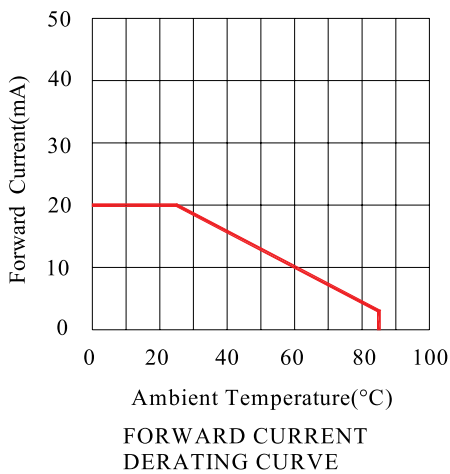
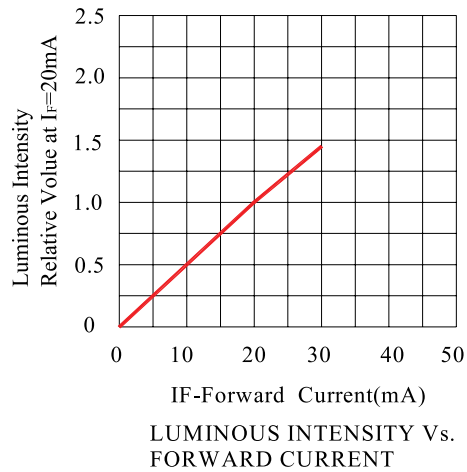
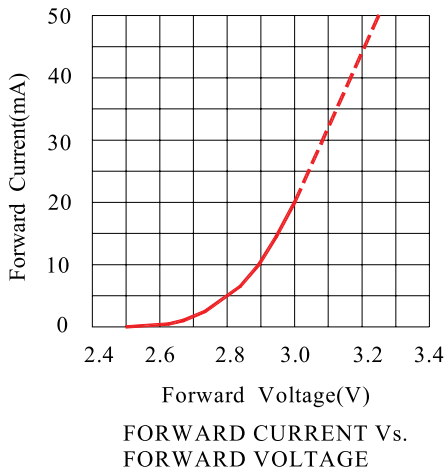

# Round LED

## 5mm, Blue

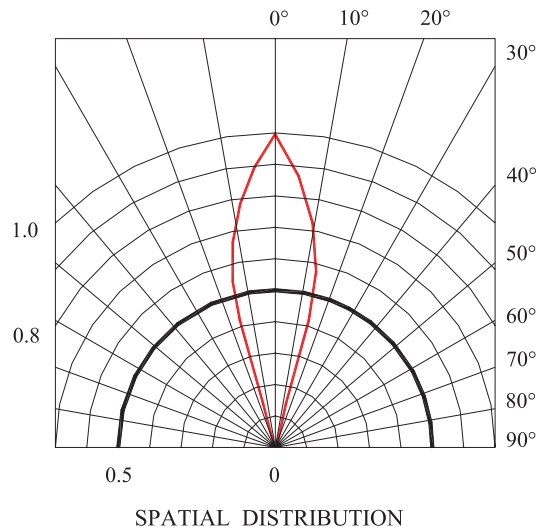
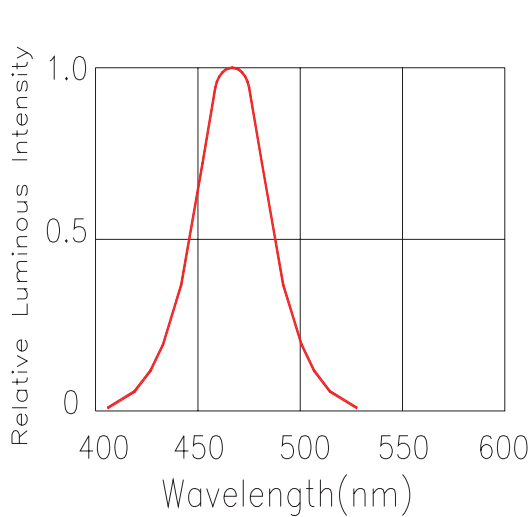

### Part Number Table

Description	Part Number
Round LED, Blue, 465nm, 30°, 4000mcd, Through hole	MP008538

**Important Notice :** This data sheet and its contents (the "Information") belong to the members of the AVNET group of companies (the "Group") or are licensed to it. No licence is granted for the use of it other than for information purposes in connection with the products to which it relates. No licence of any intellectual property rights is granted. The Information is subject to change without notice and replaces all data sheets previously supplied. The Information supplied is believed to be accurate but the Group assumes no responsibility for its accuracy or completeness, any error in or omission from it or for any use made of it. Users of this data sheet should check for themselves the Information and the suitability of the products for their purpose and not make any assumptions based on information included or omitted. Liability for loss or damage resulting from any reliance on the Information or use of it (including liability resulting from negligence or where the Group was aware of the possibility of such loss or damage arising) is excluded. This will not operate to limit or restrict the Group's liability for death or personal injury resulting from its negligence. Multicomp Pro is the registered trademark of Premier Farnell Limited 2019.