

# SA1U Photoelectric Switches

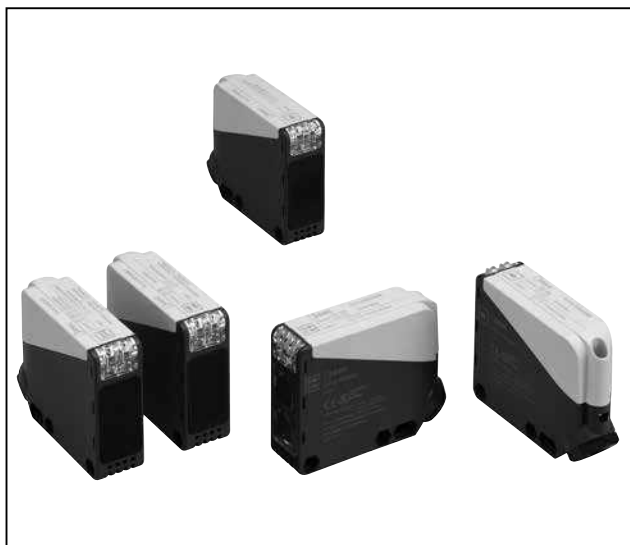

**Wide variations such as universal voltage and DC power types, available with time delay. Maximum sensing range of 50m (through-beam).**

- Universal voltage types operate on 24 to 240V AC and 12 to 240V DC. DC power types operate on 12 to 24V DC.
- Washable IP67
- Four sensing methods: through-beam, polarized retro-reflective, diffuse-reflective, and background suppression.
- Adjustable time delay: 0.1 to 5 seconds
- Mounting hole centers: 40, 50 to 55 mm
- Operation and stable LED indicators.
- SPDT contact for relay output type.
- Transistor output type has NPN and PNP open collector dual outputs.
- Interference prevention allows two units to be mounted in close proximity (except through-beam model).
- Spring-up terminal block structure enables easy wiring. Wiring can be extended to up to 100m using  $\varnothing 8$  to  $\varnothing 10$  mm round cables.

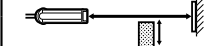
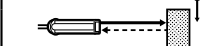

## Model

Package Quantity: 1

Sensing Method	Detectable Object	Sensing Range	Power Voltage	Control Output	Attachments	Time Delay Functions	Part No. (Ordering Part No.)
 Through-Beam	Opaque	50m max.	24 to 240V AC (50/60Hz)	Relay contact SPDT 250V AC/3A, 30V DC/3A (resistive load)	<ul style="list-style-type: none"> <li>• Sensitivity control screwdriver</li> <li>• Mounting bracket</li> <li>• Gland, gland washer</li> <li>• Gland gaskets*</li> </ul>	Without	SA1U-T50M
			12 to 240V DC			With	SA1U-T50MT
			12 to 24V DC	Without		SA1U-T50MW	
				With		SA1U-T50MWT	
 Polarized Retroreflective	Opaque Mirror surface	7m max.	24 to 240V AC (50/60Hz)	Relay contact SPDT 250V AC/3A, 30V DC/3A (resistive load)	<ul style="list-style-type: none"> <li>• Sensitivity control screwdriver</li> <li>• Reflector (IAC-R5)</li> <li>• Mounting bracket</li> <li>• Gland, gland washer</li> <li>• Gland gaskets*</li> </ul>	Without	SA1U-P07M
			12 to 240V DC			With	SA1U-P07MT
			12 to 24V DC	Without		SA1U-P07MW	
				With		SA1U-P07MWT	
 Diffuse-Reflective	Opaque Transparent	1m max.	24 to 240V AC (50/60Hz)	Relay contact SPDT 250V AC/3A, 30V DC/3A (resistive load)	<ul style="list-style-type: none"> <li>• Sensitivity control screwdriver</li> <li>• Mounting bracket</li> <li>• Gland, gland washer</li> <li>• Gland gaskets*</li> </ul>	Without	SA1U-D01M
			12 to 240V DC			With	SA1U-D01MT
			12 to 24V DC	Without		SA1U-D01MW	
				With		SA1U-D01MWT	
 Background Suppression	Opaque	2m max.	24 to 240V AC (50/60Hz)	Relay contact SPDT 250V AC/3A, 30V DC/3A (resistive load)	<ul style="list-style-type: none"> <li>• Sensitivity control screwdriver</li> <li>• Mounting bracket</li> <li>• Gland, gland washer</li> <li>• Gland gaskets*</li> </ul>	Without	SA1U-B02M
			12 to 240V DC			With	SA1U-B02MT
			12 to 24V DC	Without		SA1U-B02MW	
				With		SA1U-B02MWT	

\*Two different-size gland gaskets are supplied. Select according to the cable diameter.  
 Small hole gasket: cable diameter  $\varnothing 8$  to  $\varnothing 9$  mm  
 Large hole gasket: cable diameter  $\varnothing 9$  to  $\varnothing 10$  mm

## Accessories

Item	Part No. (Ordering Part No.)	Package Quantity	
Reflector	Standard	IAC-R5	1
	Small	IAC-R6	1
	Large	IAC-R8	1
	Narrow (rear/side mounting)	IAC-R7M	1
	Narrow (rear mounting)	IAC-R7B	1
	Narrow (side mounting)	IAC-R7S	1
	Tape (40 × 35 mm)	IAC-RS1	1
	Tape (80 × 70 mm)	IAC-RS2	1
Reflector Mounting Bracket	For IAC-R5	IAC-L2	1
	For IAC-R6	IAC-L3	1
	For IAC-R8	IAC-L5	1

Item	Slit Size (mm)	Part No.	Ordering Part No.	Package Quantity
Vertical Slit	1.0 × 22	SA9Z-S15	SA9Z-S15PN02	2
	3.0 × 22	SA9Z-S16	SA9Z-S16PN02	2

- The IAC-L2 is not supplied with reflector mounting screws (M4) and nuts.
- The IAC-L3 is supplied with two mounting screws (M3 × 8 mm sems).

## Specifications

### Universal Voltage Model

Sensing Method	Through-Beam	Polarized Retroreflective	Diffuse-Reflective	Background Suppression
Part No.	SA1U-T50M SA1U-T50MT	SA1U-P07M SA1U-P07MT	SA1U-D01M SA1U-D01MT	SA1U-B02M SA1U-B02MT
Power Voltage	24 to 240V AC (21.6 to 264V AC) 50/60Hz, 12 to 240V DC (10.8 to 264V DC) compatible			
Power Consumption	Projector: 3 VA maximum Receiver: 3 VA maximum	3 VA maximum		
Control Output	Relay contact SPDT, switching capacity: 250V AC/3A (resistive load), 30V DC/3A (resistive load) Electrical life (minimum operations): 100,000 (NO contact), 50,000 (NC contact) Mechanical life (minimum operations): 50,000,000			
Minimum Applicable Load	5V DC, 10 mA minimum (reference value)			
Response Time	20 ms maximum			
Insulation Resistance	Between power and output terminals: 20 MΩ minimum (500V DC megger)			
Dielectric Strength	Between power and output terminals: 1500V AC, 1 minute, Between output terminals: 750V AC, 1 minute			
Weight (approx.)	Projector: 115g, Receiver: 130g		130g	

### DC Power Model

Sensing Method	Through-Beam	Polarized Retroreflective	Diffuse-Reflective	Background Suppression
Part No.	SA1U-T50MW SA1U-T50MWT	SA1U-P07MW SA1U-P07MWT	SA1U-D01MW SA1U-D01MWT	SA1U-B02MW SA1U-B02MWT
Power Voltage	12 to 24V DC (10 to 30V DC) ripple rate 10% p-p maximum			
Current Draw	Projector: 20 mA maximum Receiver: 25 mA maximum	30 mA maximum		
Control Output	Type	NPN, PNP open collector (dual output)		
	Load Current	NPN: 100 mA maximum, PNP: 100 mA maximum		
	Applied Voltage	30V DC maximum		
	Voltage Drop	NPN: 2.4V maximum, PNP: 2.4V maximum		
Response Time	1 ms maximum			
Insulation Resistance	Between live and dead parts: 20 MΩ minimum (500V DC megger)			
Dielectric Strength	Between live and dead parts: 1000V AC, 1 minute			
Weight (approx.)	Projector: 105g, Receiver: 110g		110g	

### Common Specifications

Sensing Method	Through-Beam	Polarized Retroreflective	Diffuse-Reflective	Background Suppression
Sensing Distance	50m maximum	0.2 to 7m (when using supplied reflector IAC-R5)	1m maximum (200 × 200 mm white mat paper)	0.2 to 2m (200 × 200 mm white mat paper)
Preset Distance	—			0.4 to 2m (200 × 200 mm white mat paper)
Detectable Object	Opaque	Opaque/Mirror surface	Opaque/Transparent	Opaque
Hysteresis	—	—	20% of sensing distance max.	15% of sensing distance max.
Operation Mode	Light ON or Dark ON (mode selector)			
LED Indicator	[Projector] Power LED: Green [Receiver] Operation LED: Yellow Stable LED: Green	Operation LED: Yellow Stable LED: Green		Operation LED: Yellow
Light Emitting Element	Infrared LED (870 nm)	Red LED (660 nm)	Infrared LED (870 nm)	
Sensitivity Adjustment	1-turn control knob			8-turn control knob
Extraneous Light Immunity	Sunlight: 10,000 lux maximum, Incandescent lamp: 5,000 lux maximum			
Vibration Resistance	Damage limits: 10 to 55 Hz, amplitude 1.5 mm, 30 minutes in each axis			
Shock Resistance	Damage limits: 500 m/s <sup>2</sup> , 3 shocks each in 6 axes 3 consecutive times			
Operating Temperature	-25 to +60°C (no freezing), storage temperature: -40 to +70°C			
Operating Humidity	35 to 85% RH (no condensation), storage humidity: 35 to 85% RH			
Connection Method	Terminal block with M3 spring-up screws			
Applicable Cable	Outside diameter ø8 to ø10 mm (core 0.3 to 0.75 mm <sup>2</sup> )			
Cable Extension	Extendable up to 100m with a cable of 0.3 mm <sup>2</sup> minimum			
Housing Material	PBT (indicator cover: PC)			
Lens Material	PC/PET	PMMA	PC/PET	
Degree of Protection	IP67 (IEC/EN60529)			

### Time Delay Specifications

Sensing Method	Through-Beam	Polarized Retroreflective	Diffuse-Reflective	Background Suppression
Part No.	SA1U-T50MT SA1U-T50MWT	SA1U-P07MT SA1U-P07MWT	SA1U-D01MT SA1U-D01MWT	SA1U-B02MT SA1U-B02MWT
Time Range	0.1 to 5.0 sec (adjusted with the 1-turn control knob)			
Time Delay Function	One shot, ON delay, OFF delay, and normal (no delay limit operation) modes			
Temperature Effect of Time Delay	±10% maximum of the time delay for 20°C temperature rise within the operating temperature range			
Repetitive Accuracy of Time Delay	±1.0% maximum of the time delay for repetitive inputs at 10 seconds or more			

# SA1U Photoelectric Switches

## Descriptions

### Part Names

SA1U-T50M\*  
SA1U-P07M\*  
SA1U-D01M\*

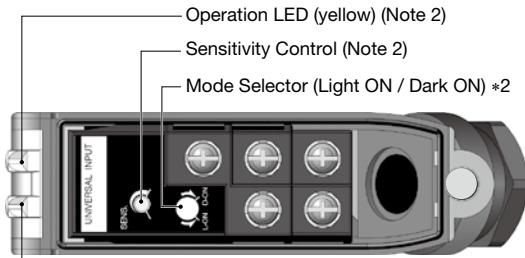

SA1U-B02M\*

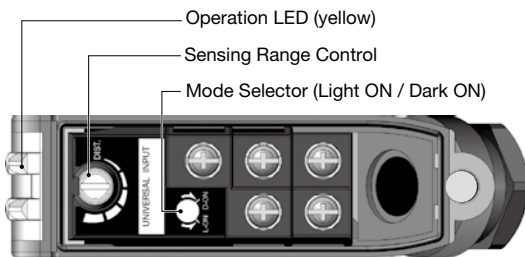

\*1: Power LED for through-beam projector  
\*2: Not available on through-beam projector

### Output Circuit / Connection Diagram

[Universal Voltage Type]

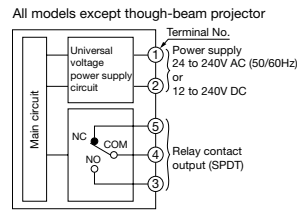

[DC Power Type]

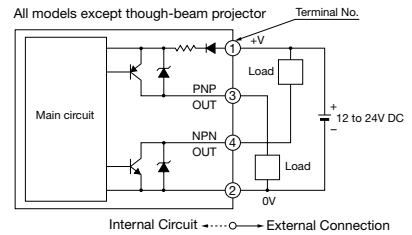

Though-beam projector

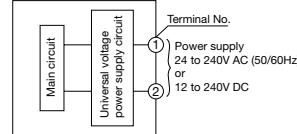

Though-beam projector

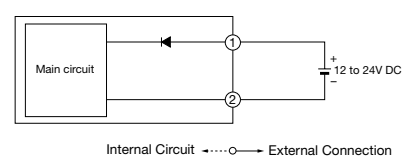

### Terminal Arrangement

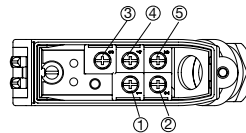

\*Terminal ③ is not available on DC power types.

### Operation Chart

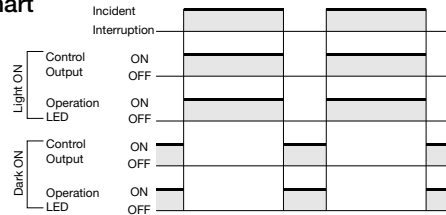

### Part Names

SA1U-T50M\*T  
SA1U-P07M\*T  
SA1U-D01M\*T

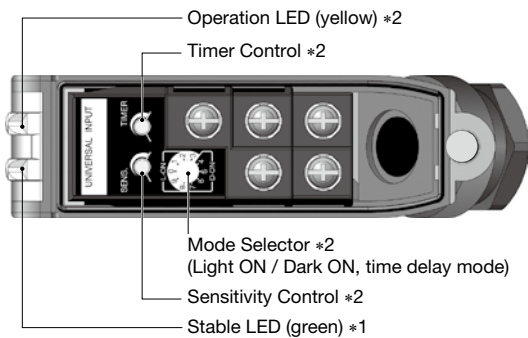

SA1U-B02M\*T

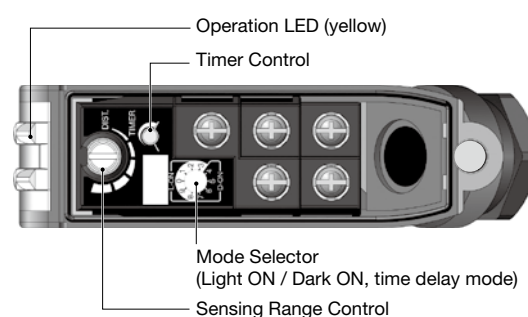

\*1: Power LED for through-beam projector  
\*2: Not available on through-beam projector

### Output Circuit / Connection Diagram

See the "Output Circuit / Connection Diagram" diagram above.

### Terminal Arrangement

See the "Terminal Arrangement" diagram above.

### Operation Chart

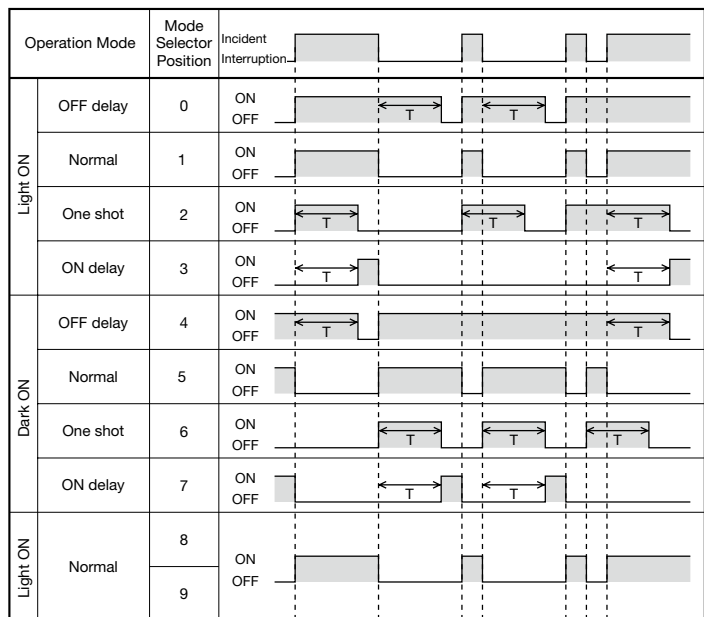

## Dimensions

### Photoelectric Switch

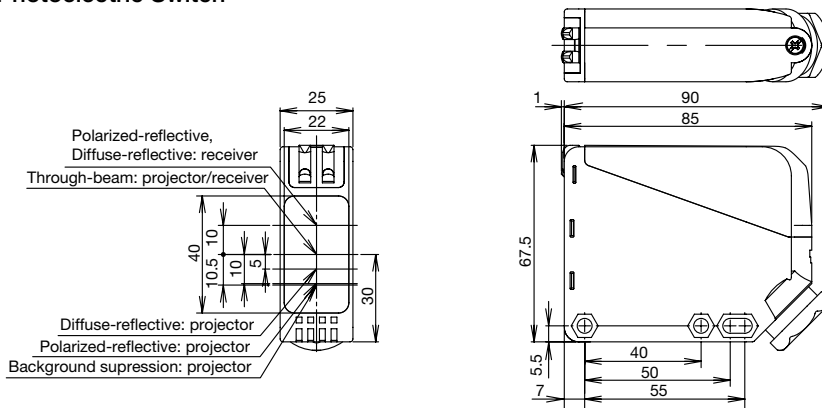

### When the Mounting Bracket is Attached

### Mounting Bracket

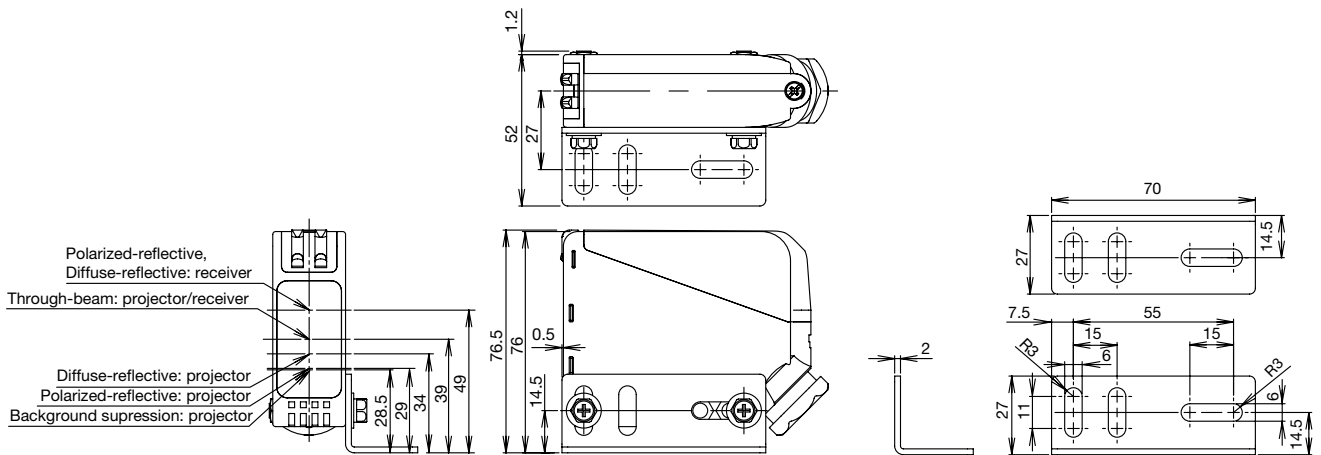

### Reflector

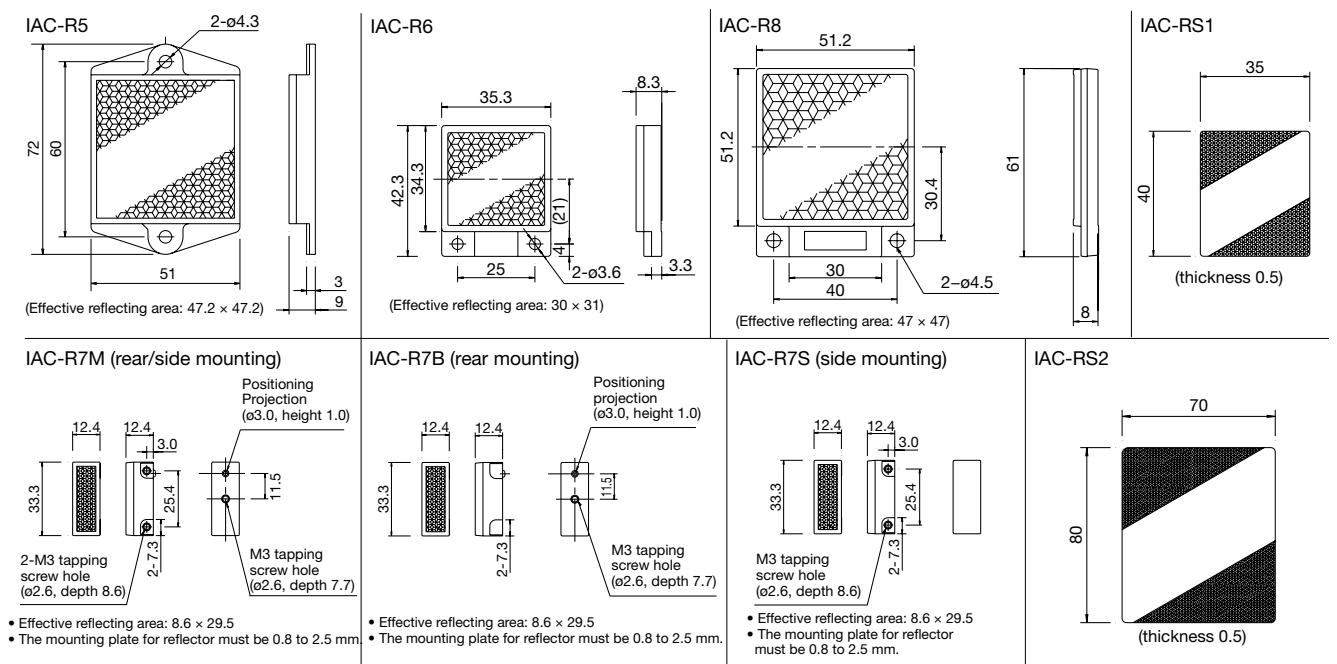

All dimensions in mm.

# SA1U Photoelectric Switches

## Dimensions

### Reflector Mounting Bracket

IAC-L2 (for IAC-R5)

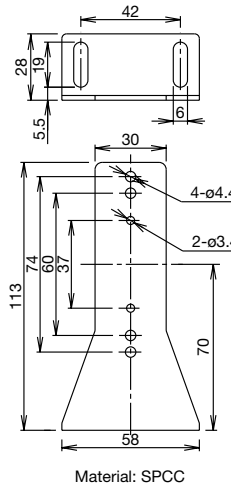

Material: SPCC

IAC-L3 (for IAC-R6)

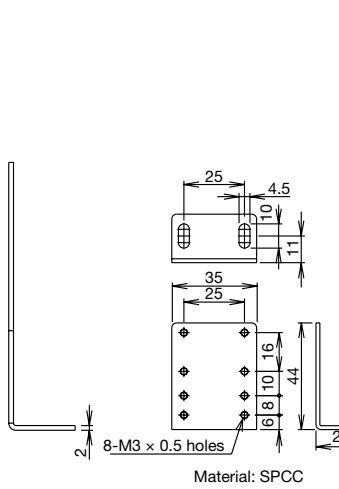

Material: SPCC

IAC-L5 (for IAC-R8)

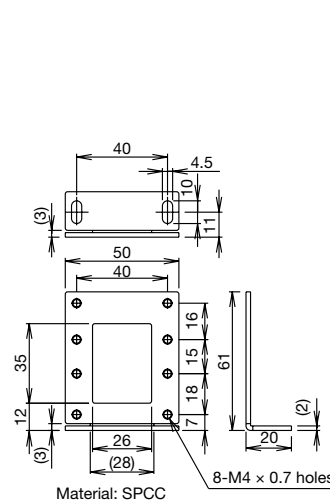

Material: SPCC

### Slit

SA9Z-S15, SA9Z-S16

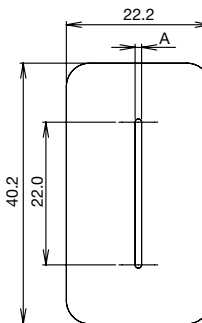

Dimension (A)

Part No.	A	Material
SA9Z-S15	1.0	PC (t=0.3)
SA9Z-S16	3.0	

All dimensions in mm.

## Characteristics (Typical)

### Through-Beam Model SA1U-T50M\*

#### • Excess Gain

(when using transparency 1% ND filter)

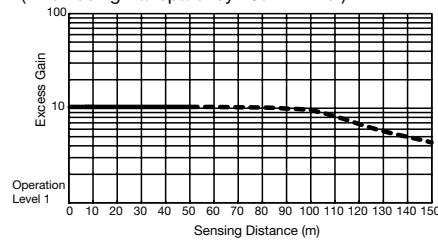

#### • Lateral Displacement

(when using transparency 2.8% ND filter)

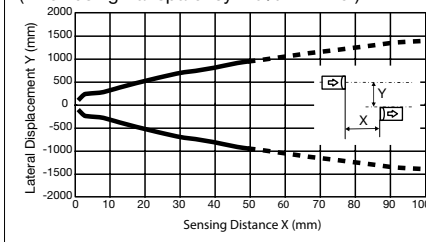

#### • Angle

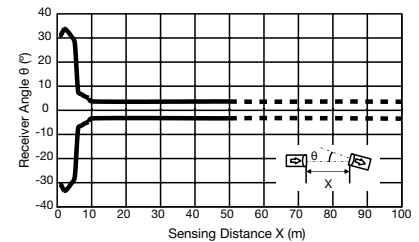

#### • Excess Gain

(when using 1.0-mm wide vertical slit)

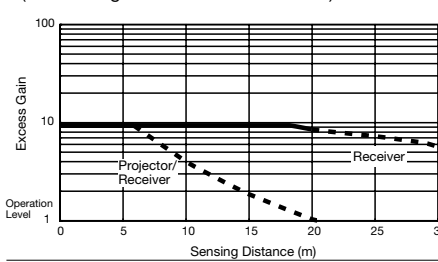

#### • Lateral Displacement

(when using 1.0-mm wide vertical slit)

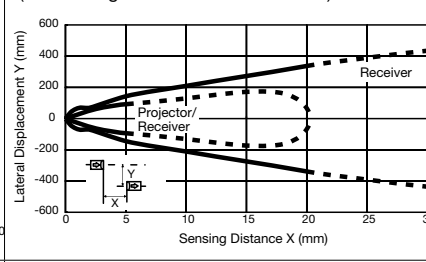

#### • Excess Gain

(when using 3.0-mm wide vertical slit)

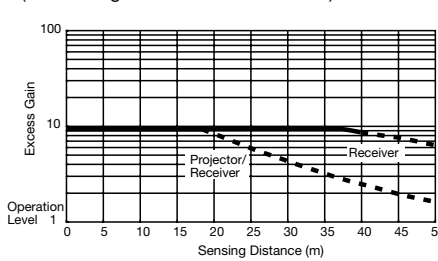

#### • Lateral Displacement

(when using 3.0-mm wide vertical slit)

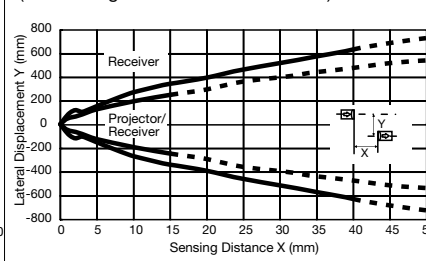

## Sensing Range and Minimum Detectable Object Size When Using Slits

Slit		Sensing Range (m)		Minimum Detectable Object Size (mm)	
Part No.	Slit Width	Slit attached on either projector or receiver	Slits attached on both projector and receiver	Slit attached on either projector or receiver	Slits attached on both projector and receiver
SA9Z-S15	1 mm	20	5	1	1
SA9Z-S16	3 mm	40	15	3	3

The slit can be easily attached to the front surface.

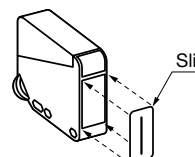

Note 1: Wipe the lens surface before sticking the slit on the lens surface.

Note 2: The slit cannot be used once it is peeled off because the adhesive power is lost.

## Polarized Retroreflective Model SA1U-P07M\*

### • Excess Gain

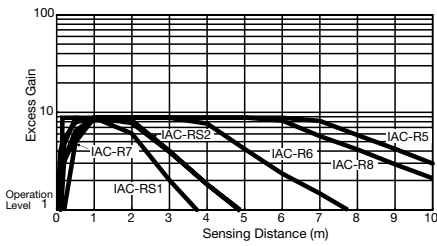

### • Lateral Displacement

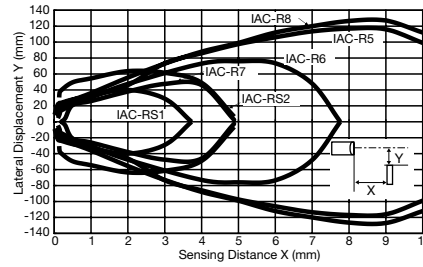

### • Angle

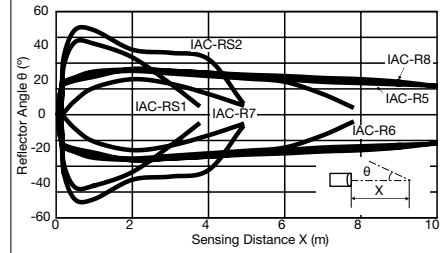

## Diffuse-Reflective Model SA1U-D01M\*

### • Excess Gain

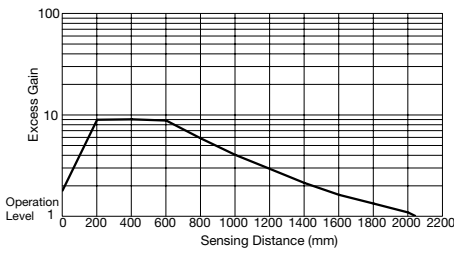

### • Lateral Displacement

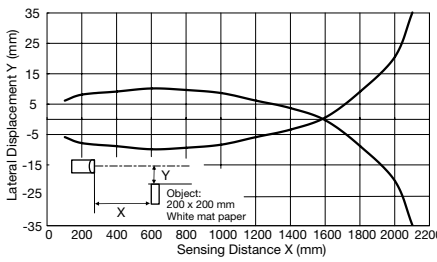

### • Object Size vs. Sensing Distance

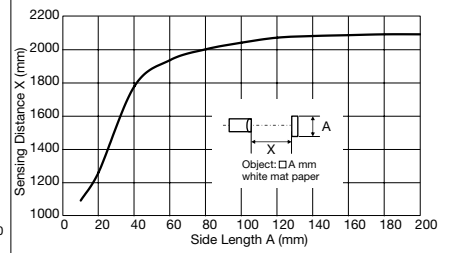

## Characteristics (Typical)

### Background Suppression Model SA1U-B02M\*

#### • Lateral Displacement (preset 1m)

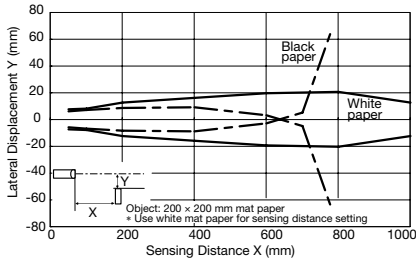

#### • Lateral Displacement (preset 2m)

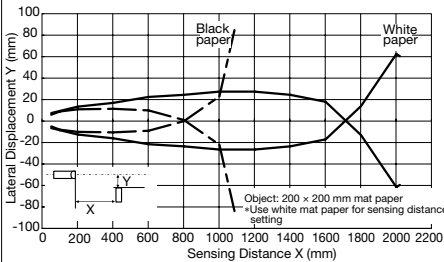

#### • Light Beam Diameter

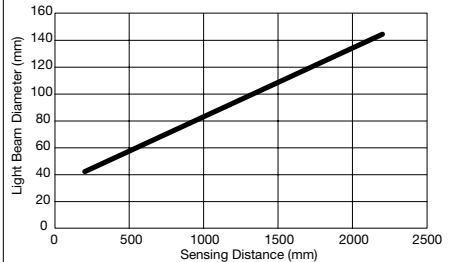

#### • Sensing Distance vs. Hysteresis

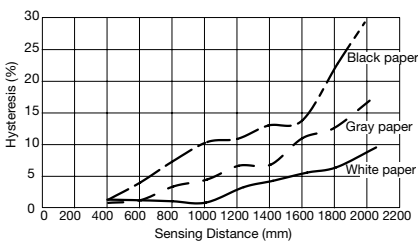

#### • Control Knob vs. Sensing Distance

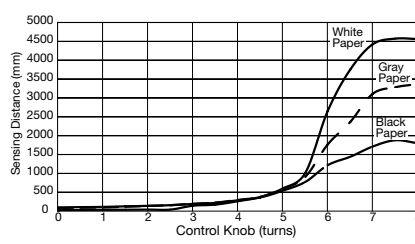

#### • Color Mat Paper and Other Materials

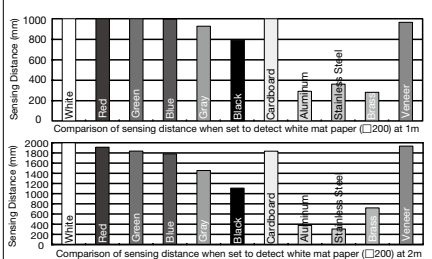

## Instructions

### Installation

Make sure that there are no gaps between the cover and the housing as shown in the diagram below.

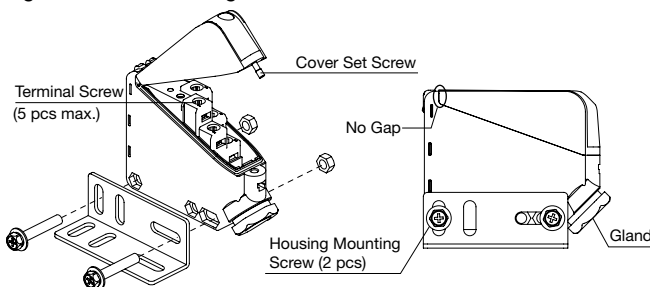

To maintain waterproof characteristics, tighten the screws within the range of the recommended tightening torque. Excessive tightening may cause damage.

#### • Screw Tightening Torque

Screw	Recommended Tightening Torque (N·m)
Terminal screw	0.6 to 1.0
Gland	4.0 to 6.0
Cover set screw	0.5 to 0.8
Housing mounting screw	0.8 to 1.2



# SA1U Photoelectric Switches

## Instructions

### Notes

- When installing photoelectric switches, take into consideration the reflecting light from the floor or walls as it may affect sensing of through-beam and background suppression models.
- Make sure to prevent sunlight, fluorescent light, and fluorescent light of inverters from entering the receiver of the photoelectric switch directly. Keep the through-beam model receiver away from intense extraneous light.
- When installing SA1U photoelectric switches, do not tighten the mounting screws excessively or hit the switch with a hammer, otherwise the protection degree cannot be maintained.
- Make sure that the supply voltage is within the rated values.
- When using a switching regulator, be sure to ground the FG (frame ground) terminal.
- To suppress a transient state at start-up, a circuit to turn off the output is installed (universal voltage type: 50 ms, DC power type: 100 ms). The timer will start after resetting the off output.
- To meet European Union Low Voltage Directives, install an EN approved fuse on the outside of the power terminal or output terminal of the universal voltage type SA1U photoelectric switches.
- Attach the cover properly to maintain waterproof characteristics.
- Interference prevention allows two SA1U photoelectric switches to be mounted in close proximity. However, the through-beam model is not equipped with interference prevention. Maintain appropriate distance between the switches referring to the lateral displacement characteristics on page 8.
- Optional slits (SA9Z-S15, SA9Z-S16) for through-beam models are available for interference prevention and to detect small objects. When using the slits, take the following into consideration:
  - 1) Wipe the lens surface of the switch with a soft dry cloth before sticking the adhesive tape side of the slit to the lens surface.
  - 2) When attaching the slit, align the ends of the slit with the ends of the lens correctly.
  - 3) The slit cannot be reused once it is peeled off because the adhesive power is lost.
  - 4) Wipe off water drops as water on the slit will change detection characteristics.
- When mounting the reflector, do not tighten the mounting screws excessively, otherwise the screw hole of the reflector may be damaged.
- Use M4 mounting screws for the IAC-R5 and IAC-R8 reflectors and M3 mounting screws for the IAC-R6 reflector. Tighten the mounting screws to a tightening torque of 0.5 N·m maximum.
- Use the M3 self-tapping screw, flat washer, and spring washer to tighten the IAC-R7 reflector to a torque of 0.5 to 0.6 N·m. While optional reflector mounting bracket IAC-L2 is not supplied with mounting screws or nuts, the IAC-L3 and IAC-L5 are supplied with mounting screws for mounting the reflector on the bracket.
- IAC-RS1 and IAC-RS2 reflectors can be installed directly on a flat surface using the adhesive tape attached to the back of the reflector. Before attaching the reflector, clean the surface to ensure secure attachment.
- Polycarbonate or acrylic resins are used for optical elements. Do not use ammonia or caustic soda for cleaning, otherwise optical elements will dissolve. To remove dust and moisture build-up, use soft dry cloth.
- Do not install the SA1U photoelectric switches in areas where the switches are subject to water, oil, and chemicals.

### Installing the Background Suppression (BGS) Model

Install the sensor head as shown below to minimize sensing errors.

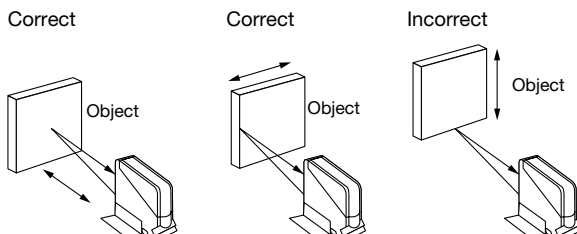

### Wiring

#### Connecting Cables

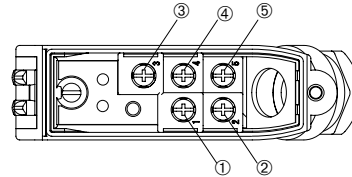
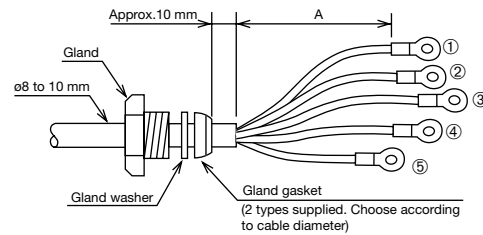

Recommended insulation length (A)

Terminal No.	①	②	③	④	⑤
Length "A" (mm)	45	30	55	40	25

- Connect the cables to the correct terminal number. Connect the lower terminal screws first.
- Attach the cover and secure with the set screw.
  - \*To maintain waterproof and dustproof characteristics, use cable-type cables (do not use soft cables as it may fall out) with  $\phi 8$  to  $\phi 10$  mm diameter. Install the attached gland gasket and washer and tighten the gland securely. For the small gland gasket, use a cable with  $\phi 8$  to  $\phi 10$  mm diameter. For the large gland gasket, use a cable with  $\phi 9$  to  $\phi 10$  mm diameter. The cable sheath should be 10 mm approx. Make sure that the gland washer fits in the groove of the gasket.
- When wiring, make sure that the power is turned off.
- Incorrect wiring may cause damage to the internal circuit.
- Avoid parallel wiring with high-voltage or power lines (especially inverters) in the same conduit, otherwise noise may cause malfunction and damage.
- When wiring is long or may be affected by power lines, use a separate conduit for wiring.
- Use a cable of 0.3 mm<sup>2</sup> minimum core wires. The cable can be extended up to 100m. For DC power types, voltage drop due to resistance of the cable lead wire should be taken into consideration.
- When using crimp terminals, make sure that the terminals do not come into contact with adjacent terminals. For correct installation, see the figure below.

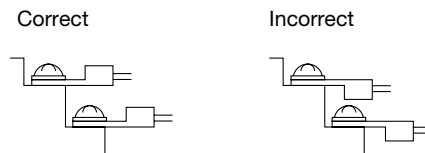

#### Dimension of Applicable Crimping Terminals

Dimensions in mm.

Ring Terminal	Spade Terminal

- When using insulation for ring terminals, use an insulating sheath.
- Install the insulation sheath to the crimp part before wiring.
- Only one crimp terminal can be connected per terminal.

## Instructions

### Indicator and Output Operation

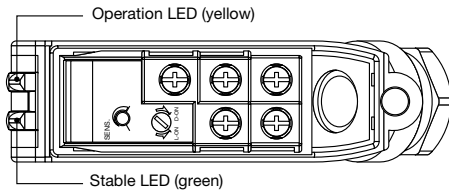

The operation LED turns on (yellow) when the control output is on. The stable LED turns on (green) either at stable incident or stable interruption. Make sure to use the SA1U photoelectric switch after the stable LED is on. See the table below.

Light Receiving Status	Stable LED (green)	Operation LED (yellow)/ Control Output	
		Light ON	Dark ON
Stable Incident	ON	ON	OFF
Unstable Incident	OFF	ON	OFF
Unstable Interruption		OFF	ON
Stable Interruption	ON	OFF	ON

### Optical Axis Alignment (Light ON)

#### (1) Through-Beam Model

Fasten the receiver temporarily. Place the projector facing the receiver. Move the projector up, down, right and left to find the range where the operation LED turns on. Fasten the projector in the middle of the range. Next, move the receiver up, down, right, and left in the same manner and fasten in the middle of the range where the operation LED turns on. Make sure that stable LED turns on at stable incident and stable interruption.

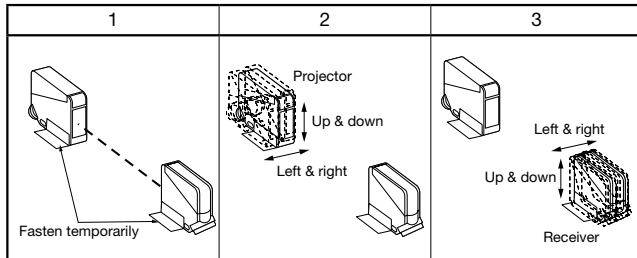

#### (2) Polarized Retroreflective Model

Install the reflector perpendicularly to the optical axis. Move the SA1U photoelectric switch up, down, right, and left to find the range where the operation LED turns on. Fasten the switch in the middle of the range. Polarized retroreflective model can be installed also by finding the position where the reflection of projected red light is most intense, while observing the reflection on the reflector from behind the switch. Make sure that stable LED turns on at stable incident and stable interruption.

#### (3) Diffuse-Reflective Model

Place the SA1U photoelectric switch where the switch can detect an object. Move the switch up, down, right, and left to find the range where the operation LED turns on. Fasten the switch in the middle of the range. Make sure that stable LED turns on at stable incident and stable interruption.

### Sensitivity Adjustment (except Background Suppression Model)

- Referring to the table below, adjust the sensitivity of the SA1U photoelectric switch when necessary, such as when the through-beam model is used to detect small or translucent objects or the reflective model is affected by background. The table explains the status of operation LED when the operation mode is set to light ON.
- After adjusting the sensitivity, make sure that stable LED turns on at stable incident and stable interruption.

- Sensitivity is set to the maximum at the factory before shipment. When adjusting the sensitivity, use the screwdriver supplied with the SA1U photoelectric switch to turn the control as shown below, to a torque of 0.03 N·m maximum.

Step	Photoelectric Switch Status	Sensitivity Control	Adjusting Procedure
1	Receiving light • Through-beam, polarized reflective: No object detected • Diffuse reflective: Object detected		Turn the control counterclockwise to the minimum. Then turn clockwise until the operation LED turns on (turns off with dark ON type) (point A).
2	Light is interrupted • Through-beam, polarized reflective: Object detected • Diffuse reflective: No object detected		At interruption status, turn the control clockwise from point A, until the operation LED turns on (turns off with dark ON type) (point B). If the operation LED does not turn on (turn off with dark ON type) even though the control has reached the maximum, set the maximum position as point B.
3	—		Set the middle point between point A and B as point C.

### Adjustment of Sensing Range for Background Suppression

When adjusting the sensing range, follow the instruction below.

Step	Distance Control	Adjusting Procedure
1		Install the photoelectric switch and the object firmly. Turn the control counterclockwise until the operation LED turns off (turns on with dark ON type). From this point, turn the control clockwise until the operation LED turns on (turns off with dark ON type) (point A).
2		Remove the object, and confirm that the operation LED turns off (turns on with dark ON type). Turn the control clockwise until the operation LED turns on (detecting the background) (turns off with dark ON type) (point B). (Note 1)
3		Set the middle point between point A and B as point C. (Note 2)

Note 1: When the background distance is too far and not detected, turn the control 360°, and set the point as point C.

Note 2: Because the control is multi-turn, it may take more than one turn to move from point A to point B.

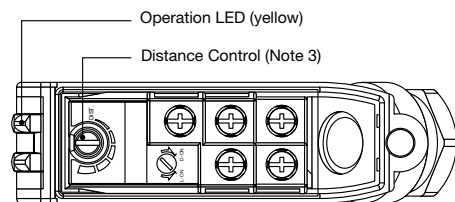

Note 3: Turning the control clockwise lengthens the sensing distance.

Note 4: Background suppression (BGS) model is not provided with a stable LED.



# SA1E Miniature Photoelectric Switches (Built-in Amplifier Model)

## Simple, small, and worldwide standard

- Six sensing methods
- Cable model (three cable lengths) and M8 connector model are available.
- NPN output, PNP output, light ON, and dark ON can be selected.
- Background suppression (BGS) model detects objects only, ignoring the background.
- Red LED model available for easy alignment in long distance applications (through-beam, polarized retroreflective, small-beam reflective, BGS)
- Convergent reflective model is ideal for detecting objects at a short distance with a background.
- Also available without sensitivity adjustment (through-beam and polarized retroreflective)
- Air blower mounting block for installing an air blower to clean the lens surface, ideal to maintain a clean lens surface and sensor performance.
- UL listed, CE marked



Sensing Method		Sensing Range	Part No.
Through-Beam		15m (SA1E-T*NA)	<ul style="list-style-type: none"> <li>•NPN output SA1E-TN*</li> <li>•PNP output SA1E-TP*</li> </ul>
Polarized Retroreflective		3.0m [100 mm] (when IAC-R5/R8 is used)	<ul style="list-style-type: none"> <li>•NPN output SA1E-PN*</li> <li>•PNP output SA1E-PP*</li> </ul>
Diffuse-Reflective		700 mm	<ul style="list-style-type: none"> <li>•NPN output SA1E-DN*</li> <li>•PNP output SA1E-DP*</li> </ul>
Small-beam Reflective		50 to 150 mm	<ul style="list-style-type: none"> <li>•NPN output SA1E-NN*</li> <li>•PNP output SA1E-NP*</li> </ul>
Background Suppression		20 to 200 mm Adjustable sensing range 40 to 200 mm	<ul style="list-style-type: none"> <li>•NPN output SA1E-BN*</li> <li>•PNP output SA1E-BP*</li> </ul>
Convergent Reflective		5 to 35 mm	<ul style="list-style-type: none"> <li>•NPN output SA1E-GN*</li> <li>•PNP output SA1E-GP*</li> </ul>



### Safety Precautions

Turn off power to the SA1U photoelectric switches before installation, removal, wiring, maintenance, and inspection. Failure to turn power off may cause electrical shock or fire hazard.

Specifications and other descriptions in this brochure are subject to change without notice.



## IDEC CORPORATION

6-64, Nishi-Miyahara 2-Chome, Yodogawa-ku, Osaka 532-0004, Japan  
Tel: +81-6-6398-2527, Fax: +81-6-6398-2547  
E-mail: marketing@idec.co.jp

**IDEC CORPORATION (USA)**  
1175 Elko Drive, Sunnyvale, CA 94089-2209, USA  
Tel: +1-408-747-0550 / (800) 262-IDEC (4332)  
Fax: +1-408-744-9055 / (800) 635-6246  
E-mail: opencontact@idec.com

**IDEC CANADA LIMITED**  
3155 Pepper Mill Court, Unit 4  
Mississauga, Ontario, L5L 4X7, Canada  
Tel: +1-905-890-8561, Toll Free: (888) 317-IDEC (4332)  
Fax: +1-905-890-8562  
E-mail: sales@ca.idec.com

**IDEC AUSTRALIA PTY. LTD.**  
Unit 17, 104 Ferntree Gully Road,  
Oakleigh, Victoria 3166, Australia  
Tel: +61-3-8523-5900, Toll Free: 1800-68-4332  
Fax: +61-3-8523-5999  
E-mail: sales@au.idec.com

**IDEC ELEKTROTECHNIK GmbH**  
Heselerstrucken 8, 22453 Hamburg, Germany  
Tel: +49-40-25 30 54 - 0, Fax: +49-40-25 30 54 - 24  
E-mail: service@eu.idec.com

**IDEC (SHANGHAI) CORPORATION**  
Room 701-702 Chong Hing Finance Center,  
No. 288 Nanjing Road West, Shanghai 200003, PRC  
Tel: +86-21-6135-1515  
Fax: +86-21-6135-6225 / +86-21-6135-6226  
E-mail: idecS@cn.idec.com

**IDEC (BEIJING) CORPORATION**  
Room 211B, Tower B, The Grand Pacific Building,  
8A Guanghua Road, Chaoyang District,  
Beijing 100026, PRC  
Tel: +86-10-6581-6131, Fax: +86-10-6581-5119

**IDEC (SHENZHEN) CORPORATION**  
Unit AB-3B2, Tian Xiang Building, Tian'an Cyber Park,  
Fu Tian District, Shenzhen, Guang Dong 518040, PRC  
Tel: +86-755-8356-2977, Fax: +86-755-8356-2944

**IDEC IZUMI (H.K.) CO., LTD.**  
Unit G & H, 26/F, MG Tower, No. 133 Hoi Bun Road,  
Kwun Tong, Kowloon, Hong Kong  
Tel: +852-2803-8989, Fax: +852-2565-0171  
E-mail: info@hk.idec.com

**IDEC TAIWAN CORPORATION**  
8F-1, No. 79, Hsin Tai Wu Road, Sec. 1,  
Hsi-Chih District, 22101 New Taipei City, Taiwan  
Tel: +886-2-2698-3929, Fax: +886-2-2698-3931  
E-mail: service@tw.idec.com

**IDEC IZUMI ASIA PTE. LTD.**  
No. 31, Tannery Lane #05-01,  
HB Centre 2, Singapore 347788  
Tel: +65-6746-1155, Fax: +65-6844-5995  
E-mail: info@sg.idec.com

**IDEC ASIA (THAILAND) CO.,LTD.**  
20th Fl., Sorachai Bldg., No.23/78,  
Soi Sukhumvit 63, Sukhumvit Rd.,  
Klongton-nua, Wattana, Bangkok 10110  
Tel: +662-392-9765, Fax: +662-392-9768  
E-mail: sales@th.idec.com