

5

4

3

2

1

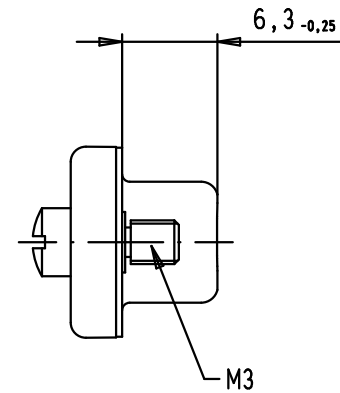
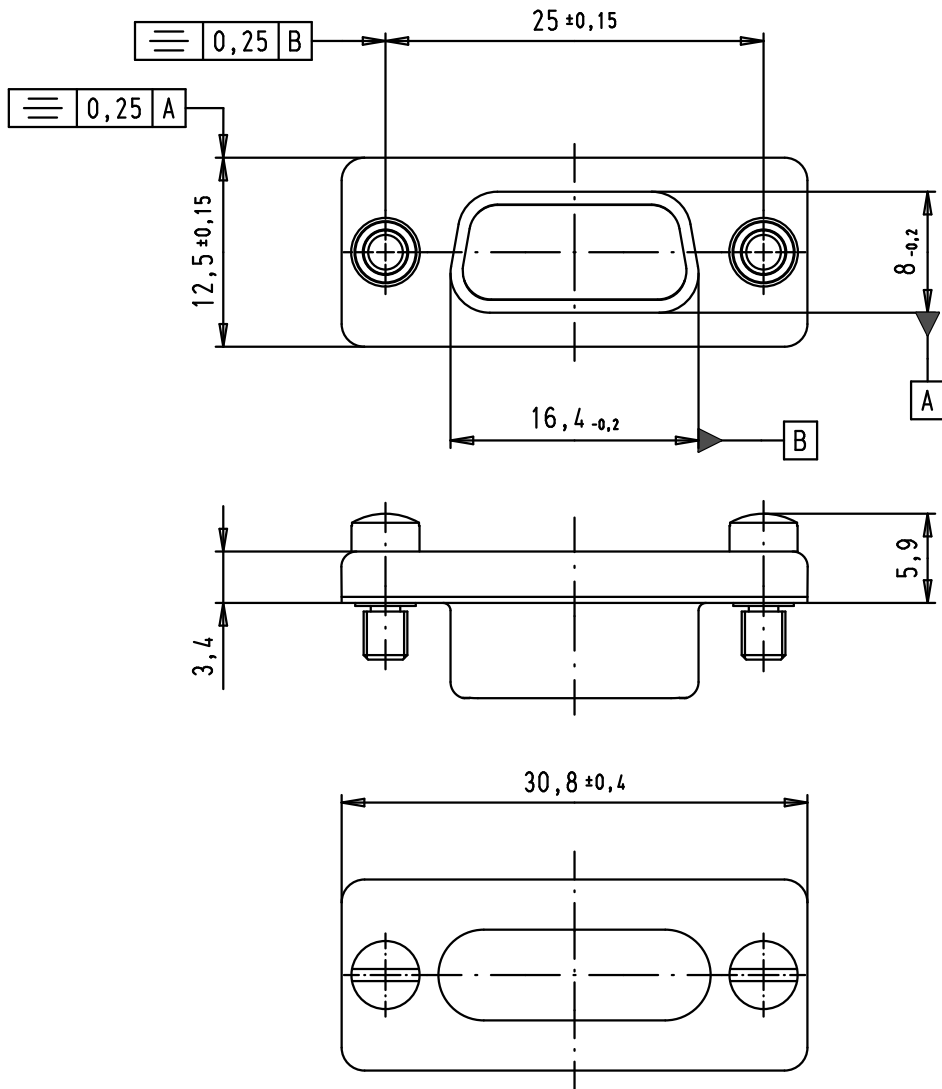

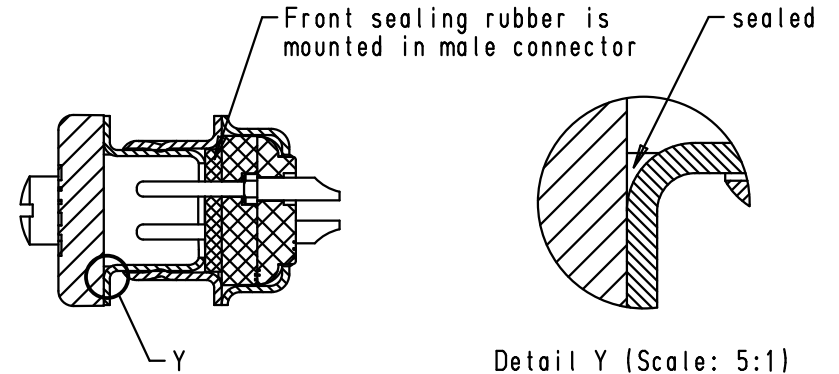

IP 67 shielding concept

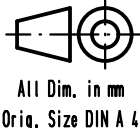

Detail Y (Scale: 5:1)

Front sealing rubber 09 67 002 9001 must be purchased separately

				Dot.	Name	 <p>All Dim. in mm Orig. Size DIN A 4</p>	IP 67 female metal shielding cap, tin plated shell for 9 poles male D-Sub with screw locks	Maßstab/ Scale
			Detail.	12/04/07	PK			2:1
			Insp.					
			Stand.					
34906	18/04/08	PK	HARTING EURL F-95972 Paris				TB 09 67 002 9065	Blatt/ Page
33977	12/04/07	PK						1 / 1
Mod.	Dot.	Name					Sub.	

D

C

B

A