



Part no.: 50130606
MD 7XXP-11-42IO5-13
Distribution box



Figure can vary

Contents

- Technical data
- Dimensioned drawings
- Circuit diagrams
- Operation and display
- Accessories

Part no.: 50130606 – MD 7XXP-11-42IO5-13 – Distribution box

Technical data

Electrical data	
Switching signal	PNP
Performance data	
Total current	8 A
Input data logic	
Nominal input voltage U_N	24 V DC

Connection	
Master connection	
Type of connection	Connector
Function	Connection to the control
Thread size	M23
No. of pins	12 -pin
Encoding	A-coded
Type	Male
Distribution box connections	
Number of connections	4 Piece(s)
Thread size	M12
No. of pins	5 -pin
Encoding	A-coded
Type	Female
Material	Plastic
Material of O-ring seal	TPU
Material of contacts	Gold-plated
Operating current per contact	1.5 A

Mechanical data	
Design	Cubic
Dimension (W x H x L)	50 mm x 36.5 mm x 100 mm
Housing material	Plastic
Net weight	140 g
Screw tightening torque	1 N·m

Operation and display	
Type of display	LED

Environmental data	
Ambient temperature, operation	-20 ... 70 °C , Depending on the connected cable

Certifications	
Degree of protection	IP 65 IP 67
Certifications	c UL US

Classification	
Customs tariff number	85369010
eCl@ss 8.0	27279219
eCl@ss 9.0	27440108

ETIM 5.0	EC002585
ETIM 6.0	EC002585

Dimensioned drawings

All dimensions in millimeters

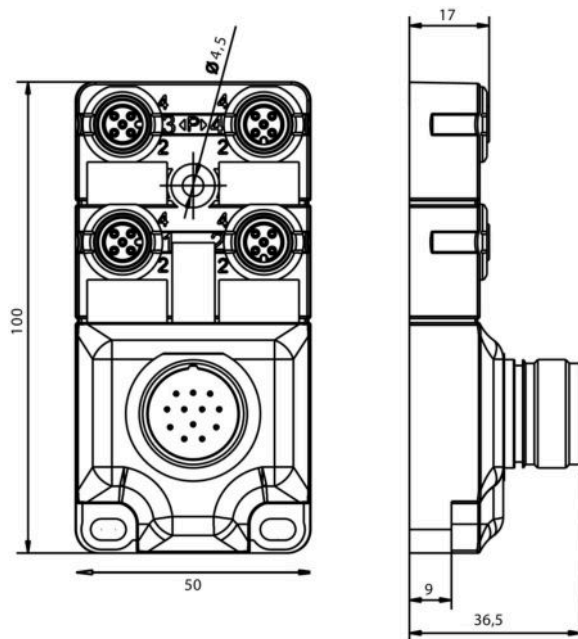

Pin	Pin assignment
1	Socket 1 / contact 4
2	Socket 2 / contact 4
3	Socket 3 / contact 4
4	Socket 4 / contact 4
5	Socket 1 / contact 2
6	Socket 2 / contact 2
7	Socket 3 / contact 2
8	Socket 4 / contact 2
9	Socket 1-4 / contact 3
10	Socket 1-4 / contact 3
11	Socket 1-4 / contact 1
12	Socket 1-4 / contact 5

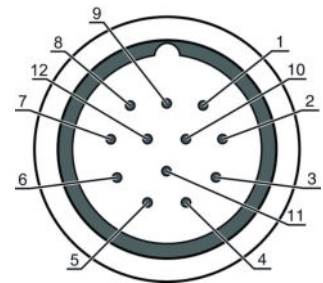

Pin	Pin assignment
1	+
2	Signal 2 (NC)
3	-
4	Signal 1 (NO)
5	PE

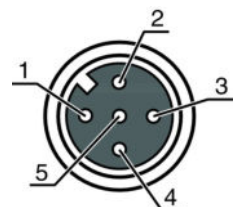

Circuit diagrams

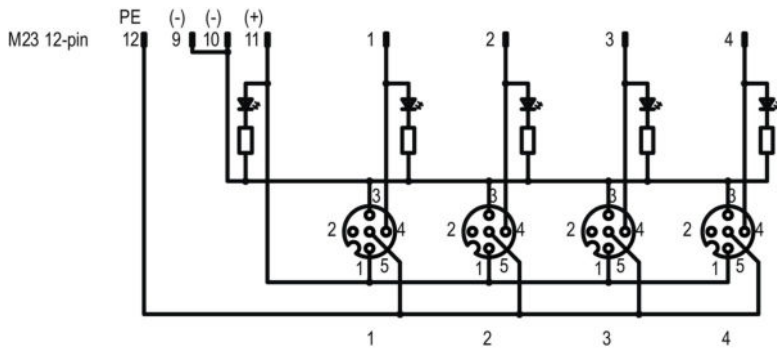



Operation and display

LEDs

LED	Display	Meaning
1	Green, continuous light	Operating voltage applied
2	Yellow, continuous light	Signal 1
3	White, continuous light	Signal 2

Accessories

Connection technology - Connection cables

	Part no.	Designation	Article	Description
	50134969	KD U-M23-CA-P1-050	Connection cable	Connection 1: Connector, M23, Axial, Female, A-coded, 12 -pin Connection 2: Open end Shielded: No Cable length: 5,000 mm Sheathing material: PUR
	50134973	KD U-M23-CW-P1-050	Connection cable	Connection 1: Connector, M23, Angled, Female, A-coded, 12 -pin Connection 2: Open end Shielded: No Cable length: 5,000 mm Sheathing material: PUR

General

	Part no.	Designation	Article	Description
	50134480	CAP M12K-Set	Connection cap	Type: Cap for free sockets Thread size: M12 Material: Plastic

Part no.: 50130606 – MD 7XXP-11-42IO5-13 – Distribution box

Note

A list with all available accessories can be found on the Leuze electronic website in the Download tab of the article detailed page.