









Support filaire écran 42" - 75" 3m
Wired screen support 42" - 75" 3m
Capacité : 30kg par écran
Capacity: 30kg per screen
VESA: 400x600mm







Liste



A1	A2	A3	A4
M5X15 	M6X15 	M8X15 	Ø16xØ6.2x1.5 
X4	X4	X4	X4

X1

B1	B2	B3	B4
	6mm 	Ø16xØ6.2x1.5 	Ø6x50 
X2	X8	X8	X8

X2

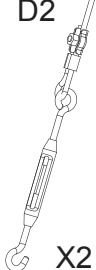
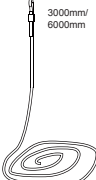
C1	C2	C3	C4	C5	C6
				5mm 	
X1	X4	X4	X4	X1	X4

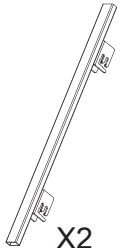
D1	D2	D3	D4	D5
		 3000mm/ 6000mm		
X4	X2	X2	X2	X2

Installation

1

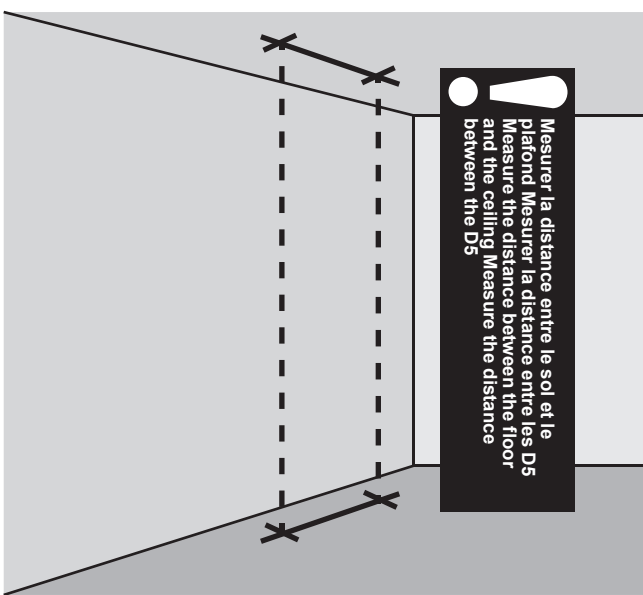

Mesurer la distance entre le sol et le plafond. Mesurer la distance entre les D5 and the ceiling. Measure the distance between the floor and the ceiling. Measure the distance between the D5

Confirmer la hauteur et la largeur d'installation

Confirm installation height and width

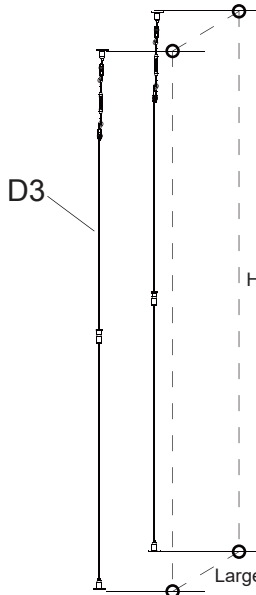

D3

Hauteur / Height

Largeur / Width (3000mm)

2

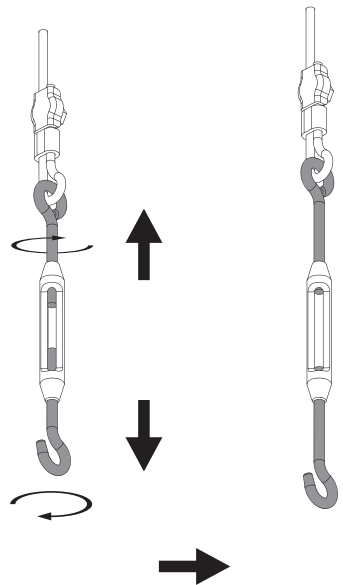

3

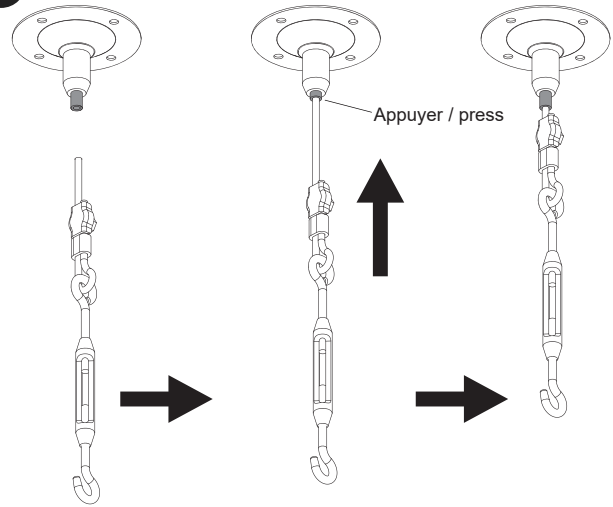

Appuyer / press

