



Silicon PIN Photodiode



21568-1 VEMD2020X01



VEMD2000X01

DESCRIPTION

VEMD2000X01 and VEMD2020X01 are high speed and high sensitive PIN photodiodes in a miniature surface mount package (SMD) with dome lens and daylight blocking filter. Filter is matched with IR emitters operating at wavelength of 830 nm to 950 nm. The photo sensitive area of the chip is 0.23 mm².

FEATURES

- Package type: surface mount
- Package form: GW, RGW
- Dimensions (L x W x H in mm): 2.3 x 2.3 x 2.8
- AEC-Q101 qualified
- High radiant sensitivity
- Daylight blocking filter matched with 830 nm to 950 nm IR emitters
- Fast response times
- Angle of half sensitivity: $\phi = \pm 15^\circ$
- Package matched with IR emitter series VSMB2000X01
- Floor life: 4 weeks, MSL 2a, acc. J-STD-020
- Lead (Pb)-free reflow soldering
- Compliant to RoHS Directive 2002/95/EC and in accordance to WEEE 2002/96/EC



Note

** Please see document "Vishay Material Category Policy": www.vishay.com/doc?99902

APPLICATIONS

- High speed photo detector
- Infrared remote control
- Infrared data transmission
- Photo interrupters
- Shaft encoders

| PRODUCT SUMMARY | | | |
|-----------------|----------------------|---------|-----------------------|
| COMPONENT | I _{ra} (μA) | φ (deg) | λ _{0.5} (nm) |
| VEMD2000X01 | 12 | ± 15 | 750 to 1050 |
| VEMD2020X01 | 12 | ± 15 | 750 to 1050 |

Note

- Test conditions see table "Basic Characteristics"

| ORDERING INFORMATION | | | |
|----------------------|---------------|------------------------------|------------------|
| ORDERING CODE | PACKAGING | REMARKS | PACKAGE FORM |
| VEMD2000X01 | Tape and reel | MOQ: 6000 pcs, 6000 pcs/reel | Reverse gullwing |
| VEMD2020X01 | Tape and reel | MOQ: 6000 pcs, 6000 pcs/reel | Gullwing |

Note

- MOQ: minimum order quantity

| ABSOLUTE MAXIMUM RATINGS (T _{amb} = 25 °C, unless otherwise specified) | | | | |
|---|-----------------------------------|-------------------|---------------|------|
| PARAMETER | TEST CONDITION | SYMBOL | VALUE | UNIT |
| Reverse voltage | | V _R | 60 | V |
| Power dissipation | T _{amb} ≤ 25 °C | P _V | 215 | mW |
| Junction temperature | | T _j | 100 | °C |
| Operating temperature range | | T _{amb} | - 40 to + 100 | °C |
| Storage temperature range | | T _{stg} | - 40 to + 100 | °C |
| Soldering temperature | Acc. reflow solder profile fig. 7 | T _{sd} | 260 | °C |
| Thermal resistance junction/ambient | Acc. J-STD-051 | R _{thJA} | 250 | K/W |



| BASIC CHARACTERISTICS ($T_{amb} = 25\text{ }^{\circ}\text{C}$, unless otherwise specified) | | | | | | |
|---|---|-----------------|------|-------------|------|---------------|
| PARAMETER | TEST CONDITION | SYMBOL | MIN. | TYP. | MAX. | UNIT |
| Forward voltage | $I_F = 50\text{ mA}$ | V_F | | 1 | | V |
| Breakdown voltage | $I_R = 100\text{ }\mu\text{A}$, $E = 0$ | $V_{(BR)}$ | 32 | | | V |
| Reverse dark current | $V_R = 10\text{ V}$, $E = 0$ | I_{ro} | | 1 | 10 | nA |
| Diode capacitance | $V_R = 0\text{ V}$, $f = 1\text{ MHz}$, $E = 0$ | C_D | | 4 | | pF |
| | $V_R = 5\text{ V}$, $f = 1\text{ MHz}$, $E = 0$ | C_D | | 1.3 | | pF |
| Open circuit voltage | $E_e = 1\text{ mW/cm}^2$, $\lambda = 950\text{ nm}$ | V_o | | 350 | | mV |
| Temperature coefficient of V_o | $E_e = 1\text{ mW/cm}^2$, $\lambda = 950\text{ nm}$ | TK_{V_o} | | -2.6 | | mV/K |
| Short circuit current | $E_e = 1\text{ mW/cm}^2$, $\lambda = 950\text{ nm}$ | I_k | | 11 | | μA |
| Temperature coefficient of I_k | $E_e = 1\text{ mW/cm}^2$, $\lambda = 950\text{ nm}$ | TK_{I_k} | | 0.1 | | %/K |
| Reverse light current | $E_e = 1\text{ mW/cm}^2$, $\lambda = 950\text{ nm}$, $V_R = 5\text{ V}$ | I_{ra} | 8.5 | 12 | 17 | μA |
| Angle of half sensitivity | | ϕ | | ± 15 | | deg |
| Wavelength of peak sensitivity | | λ_p | | 940 | | nm |
| Range of spectral bandwidth | | $\lambda_{0.5}$ | | 750 to 1050 | | nm |
| Rise time | $V_R = 10\text{ V}$, $R_L = 1\text{ k}\Omega$, $\lambda = 820\text{ nm}$ | t_r | | 100 | | ns |
| Fall time | $V_R = 10\text{ V}$, $R_L = 1\text{ k}\Omega$, $\lambda = 820\text{ nm}$ | t_f | | 100 | | ns |

BASIC CHARACTERISTICS ($T_{amb} = 25\text{ }^{\circ}\text{C}$, unless otherwise specified)

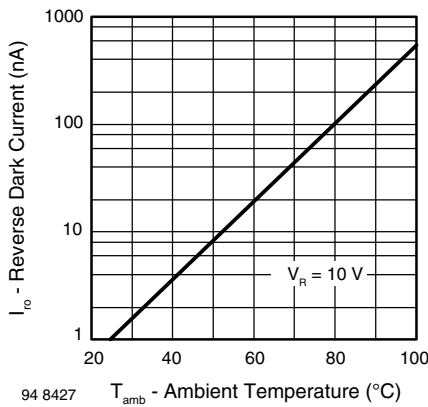

Fig. 1 - Reverse Dark Current vs. Ambient Temperature

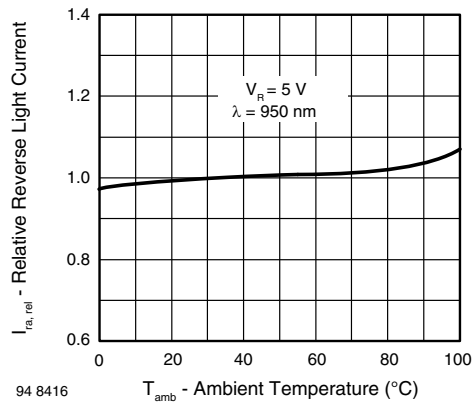

Fig. 2 - Relative Reverse Light Current vs. Ambient Temperature

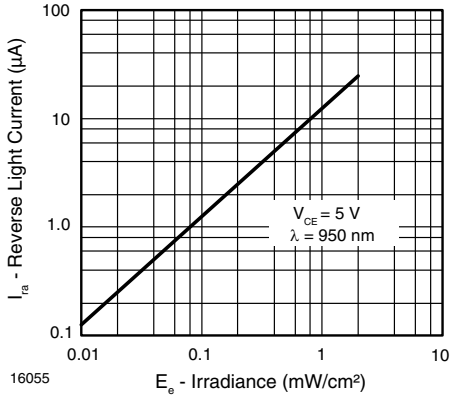

Fig. 3 - Reverse Light Current vs. Irradiance

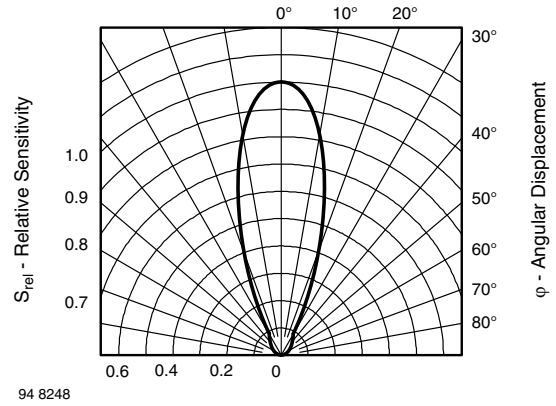

Fig. 6 - Relative Radiant Intensity vs. Angular Displacement

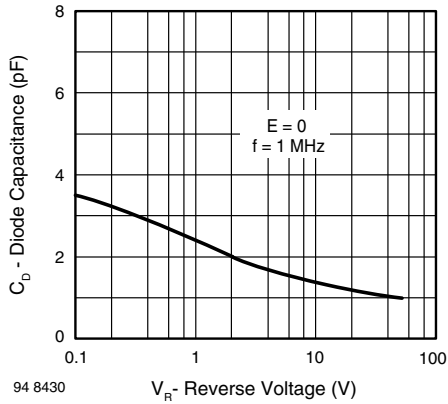

Fig. 4 - Diode Capacitance vs. Reverse Voltage

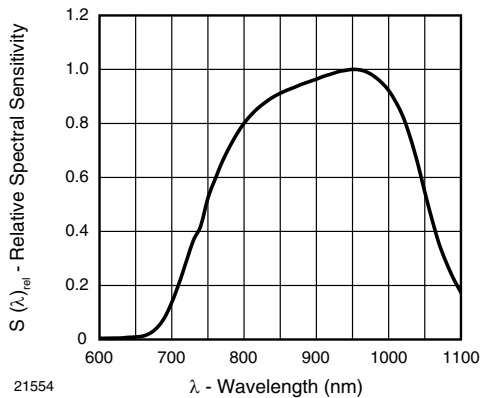

Fig. 5 - Relative Spectral Sensitivity vs. Wavelength



REFLOW SOLDER PROFILE



Fig. 7 - Lead (Pb)-free Reflow Solder Profile acc. J-STD-020D

DRYPACK

Devices are packed in moisture barrier bags (MBB) to prevent the products from moisture absorption during transportation and storage. Each bag contains a desiccant.

FLOOR LIFE

Floor life (time between soldering and removing from MBB) must not exceed the time indicated on MBB label:

Floor life: 4 weeks

Conditions: $T_{amb} < 30\text{ °C}$, RH < 60 %

Moisture sensitivity level 2a, acc. to J-STD-020.

DRYING

In case of moisture absorption devices should be baked before soldering. Conditions see J-STD-020 or label. Devices taped on reel dry using recommended conditions 192 h at 40 °C (+ 5 °C), RH < 5 %.

PACKAGE DIMENSIONS in millimeters: VEMD2000

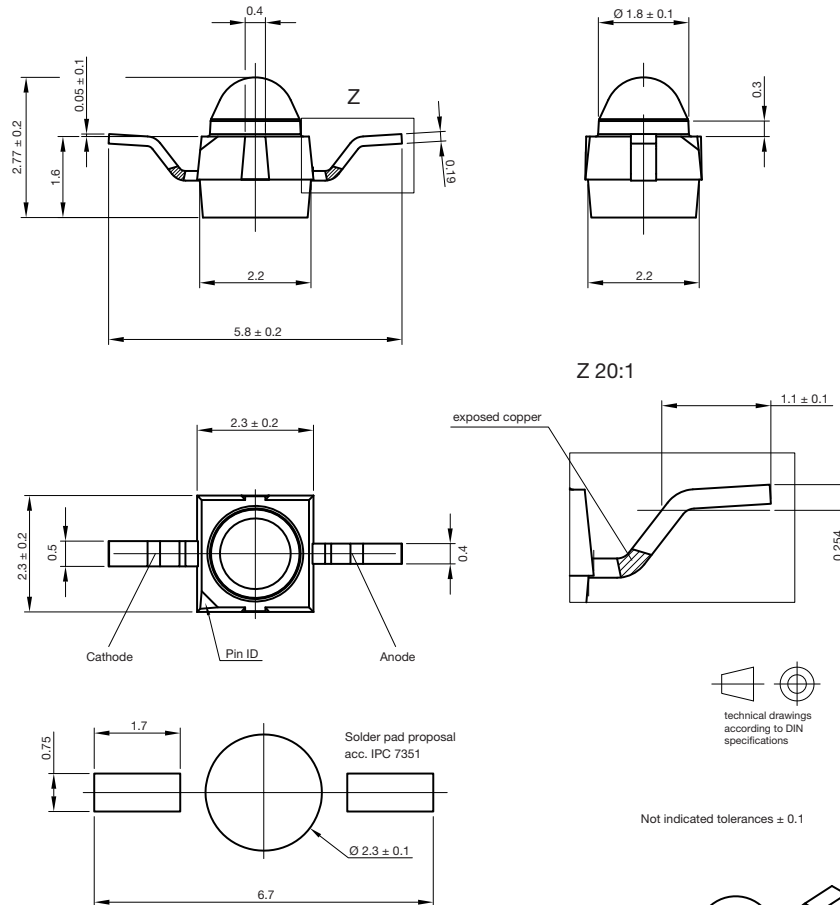

Drawing-No.: 6.544-5391.02-4
Issue: 2; 18.03.10
21517

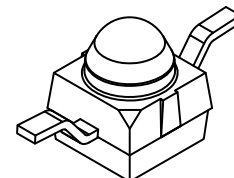



PACKAGE DIMENSIONS in millimeters: VEMD2020

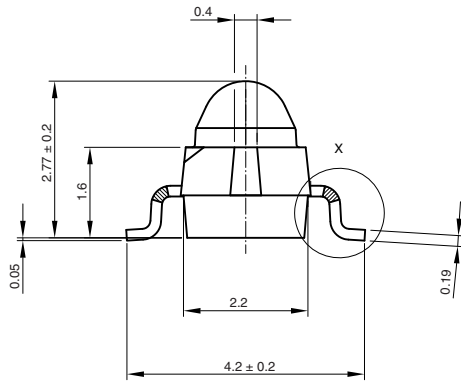

X 20:1

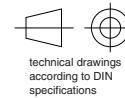

Not indicated tolerances ± 0.1

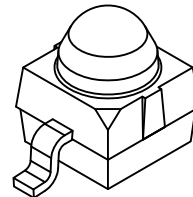

Drawing-No.: 6.544-5383.02-4
 Issue: 4; 18.03.10
 21488



TAPING AND REEL DIMENSIONS in millimeters: **VEMD2000**

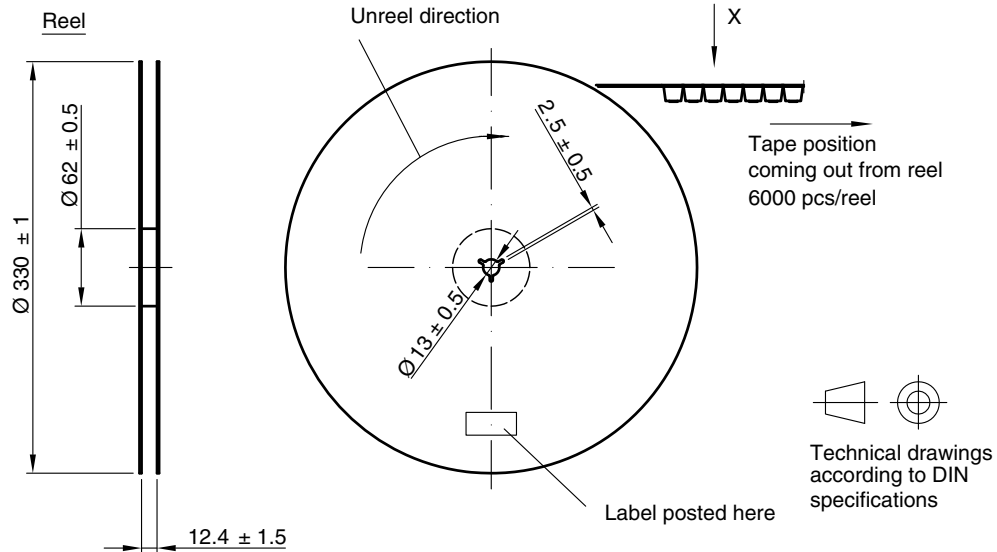

Technical drawings according to DIN specifications

Leader and trailer tape:

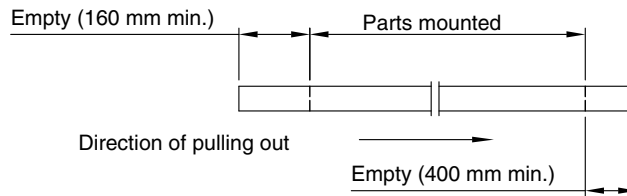

Terminal position in tape

| Device | Lead I | Lead II |
|------------|-----------|---------|
| VEMT2000 | Collector | Emitter |
| VEMT2500 | | |
| VEMD2000 | Cathode | Anode |
| VEMD2500 | | |
| VSMB2000 | | |
| VSMG2000 | Anode | Cathode |
| VSMY2850RG | | |

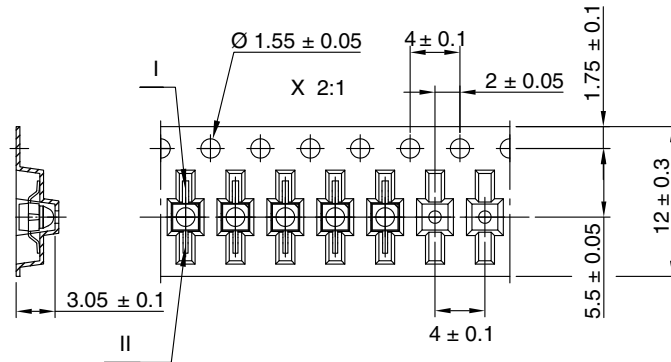

Drawing-No.: 9.800-5100.01-4
 Issue: 2; 18.03.10
 21572

TAPING AND REEL DIMENSIONS in millimeters: VEMD2020

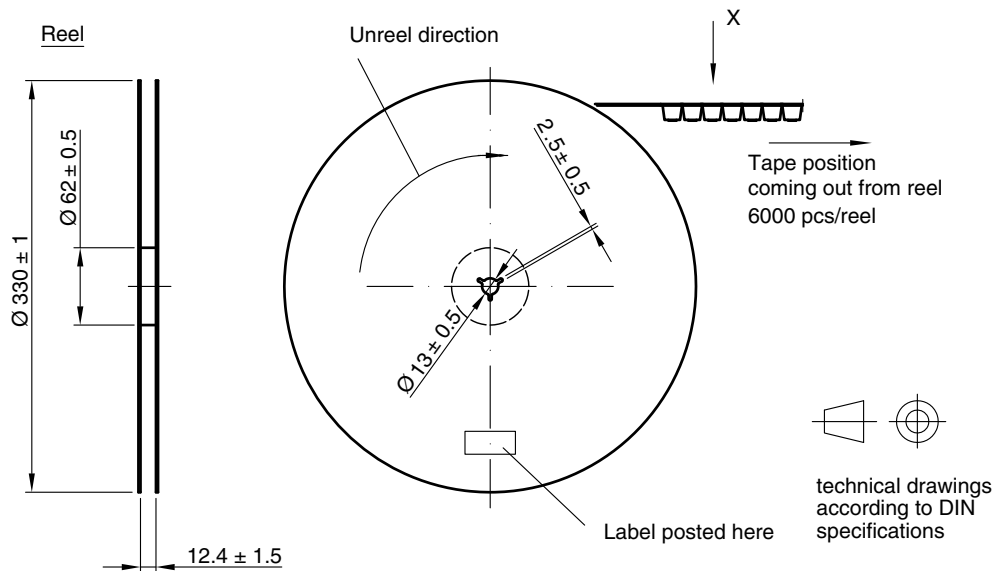

Leader and trailer tape:



Terminal position in tape

| Device | Lead I | Lead II |
|-----------|-----------|---------|
| VEMT2020 | Collector | Emitter |
| VEMT2520 | | |
| VSMB2020 | Cathode | Anode |
| VSMG2020 | | |
| VEMD2020 | | |
| VEMD2520 | Anode | Cathode |
| VSMY2850G | | |



Drawing-No.: 9.800-5091.01-4

Issue: 3; 18.03.10

21571



Disclaimer

ALL PRODUCT, PRODUCT SPECIFICATIONS AND DATA ARE SUBJECT TO CHANGE WITHOUT NOTICE TO IMPROVE RELIABILITY, FUNCTION OR DESIGN OR OTHERWISE.

Vishay Intertechnology, Inc., its affiliates, agents, and employees, and all persons acting on its or their behalf (collectively, "Vishay"), disclaim any and all liability for any errors, inaccuracies or incompleteness contained in any datasheet or in any other disclosure relating to any product.

Vishay makes no warranty, representation or guarantee regarding the suitability of the products for any particular purpose or the continuing production of any product. To the maximum extent permitted by applicable law, Vishay disclaims (i) any and all liability arising out of the application or use of any product, (ii) any and all liability, including without limitation special, consequential or incidental damages, and (iii) any and all implied warranties, including warranties of fitness for particular purpose, non-infringement and merchantability.

Statements regarding the suitability of products for certain types of applications are based on Vishay's knowledge of typical requirements that are often placed on Vishay products in generic applications. Such statements are not binding statements about the suitability of products for a particular application. It is the customer's responsibility to validate that a particular product with the properties described in the product specification is suitable for use in a particular application. Parameters provided in datasheets and/or specifications may vary in different applications and performance may vary over time. All operating parameters, including typical parameters, must be validated for each customer application by the customer's technical experts. Product specifications do not expand or otherwise modify Vishay's terms and conditions of purchase, including but not limited to the warranty expressed therein.

Except as expressly indicated in writing, Vishay products are not designed for use in medical, life-saving, or life-sustaining applications or for any other application in which the failure of the Vishay product could result in personal injury or death. Customers using or selling Vishay products not expressly indicated for use in such applications do so at their own risk. Please contact authorized Vishay personnel to obtain written terms and conditions regarding products designed for such applications.

No license, express or implied, by estoppel or otherwise, to any intellectual property rights is granted by this document or by any conduct of Vishay. Product names and markings noted herein may be trademarks of their respective owners.

Material Category Policy

Vishay Intertechnology, Inc. hereby certifies that all its products that are identified as RoHS-Compliant fulfill the definitions and restrictions defined under Directive 2011/65/EU of The European Parliament and of the Council of June 8, 2011 on the restriction of the use of certain hazardous substances in electrical and electronic equipment (EEE) - recast, unless otherwise specified as non-compliant.

Please note that some Vishay documentation may still make reference to RoHS Directive 2002/95/EC. We confirm that all the products identified as being compliant to Directive 2002/95/EC conform to Directive 2011/65/EU.

Vishay Intertechnology, Inc. hereby certifies that all its products that are identified as Halogen-Free follow Halogen-Free requirements as per JEDEC JS709A standards. Please note that some Vishay documentation may still make reference to the IEC 61249-2-21 definition. We confirm that all the products identified as being compliant to IEC 61249-2-21 conform to JEDEC JS709A standards.