



TAOGLAS®



Datasheet

Part No:
GW.05.0153

Description:

Dual-Band Wi-Fi 2.4~2.5GHz/5.15~5.85GHz Terminal Mount Monopole Antenna
Also Covering Wi-Fi 6 Frequencies

Features:

High Efficiency – with and without ground plane
Wi-Fi 2.4/5.8/7.1GHz
Covers Wi-Fi 6 Frequencies: 5.9-71GHz
Extremely Compact - 62.3mm ± 1.5mm
Aesthetic look and feel
Unique can rotate 360 degrees and articulate through 180 degrees
Max Peak Gain compliant with most Wi-Fi modules
Connector: RP-SMA(M)
Dimensions: 62.3*Ø10mm
RoHS & Reach Compliant

1. Introduction	3
2. Specifications	5
3. Antenna Characteristics	8
4. Radiation Patterns	12
5. Mechanical Drawing	22
6. Installation	23
7. Packaging	24
<hr/>	
Changelog	25

Taoglas makes no warranties based on the accuracy or completeness of the contents of this document and reserves the right to make changes to specifications and product descriptions at any time without notice. Taoglas reserves all rights to this document and the information contained herein. Reproduction, use or disclosure to third parties without express permission is strictly prohibited.



1. Introduction



The GW.05 dual band Wi-Fi Hinged Rotatable Antenna is a high efficiency monopole antenna with the capacity to cover Wi-Fi 6 frequencies up to 7.125GHz. Compared to other much larger antennas on the market, it has superior wide-band high efficiency characteristics. The bright green colour of the antenna adds a unique quality look and feel to any modern Wi-Fi application point, device or router. It also provides differentiation if using Taoglas other similar looking antennas (such as the black color Taoglas TG.09 cellular antenna) on same device.

The GW.05, as all monopole antennas, works best connected directly to the ground-plane of the device main PCB or to the outside of a metal housing. However, it still has very good performance (>50%) even without connecting to a ground-plane, making it the best all round small Wi-Fi terminal antenna on the market.

In the un-grounded installation condition, it also comes below the max peak gain requirements for most Wi-Fi modules which are usually 2dBi, so it can comply with FCC regulations. The GW.05 is for Wi-Fi, WLAN, Zigbee, Bluetooth, and 802.11a/b/g/n/ac applications.

Many module manufacturers specify peak gain limits for any antennas that are to be connected to that module. Those peak gain limits are based on free-space conditions. In practice, the peak gain of an antenna tested in free-space can degrade by at least 1 or 2dBi when put inside a device. So ideally you should go for a slightly higher peak gain antenna than mentioned on the module specification to compensate for this effect, giving you better performance.

Upon testing of any of our antennas with your device and a selection of appropriate layout, integration technique, or cable, Taoglas can make sure any of our antennas' peak gain will be below the peak gain limits. Taoglas can then issue a specification and/or report for the selected antenna in your device that will clearly show it complying with the peak gain limits, so you can be assured you are meeting regulatory requirements for that module.

For example, a module manufacturer may state that the antenna must have less than 2dBi peak gain, but you don't need to select an embedded antenna that has a peak gain of less than 2dBi in free-space. This will give you a less optimized solution. It is better to go for a slightly higher free-space peak gain of 3dBi or more if available. Once that antenna gets integrated into your device, performance will degrade below this 2dBi peak gain due to the effects of GND plane, surrounding components, and device housing. If you want to be absolutely sure, contact Taoglas and we will test. Choosing a Taoglas antenna with a higher peak gain than what is specified by the module manufacturer and enlisting our help will ensure you are getting the best performance possible without exceeding the peak gain limits.

It is better not to select an embedded antenna with very low free-space peak gain (<2dBi) directly, as this antenna would have worse performance in your device, and lead to compromised performance compared to using a Taoglas antenna.

This antenna's colour and connector and be customized subject to NRE, for further information please contact your regional Taoglas customer support team.



2. Specifications

Free Space Electrical									
Band	Frequency (MHz)	Setup	Efficiency (%)	Average Gain (dB)	Peak Gain (dBi)	Impedance	Max Power Input	Polarization	Radiation Pattern
2.4GHz Wi-Fi	2400~2500	Straight	76.7	-1.2	2.8	50Ω	10W	Linear	Omnidirectional
		90° Bent	75.9	-1.2	2.7				
5.8GHz Wi-Fi	5150~5850	Straight	87.5	-0.6	3.6				
		90° Bent	82.1	-0.9	2.8				
7.1GHz Wi-Fi 6	5925~7125	Straight	75.8	-1.2	4.1				
		90° Bent	80	-1	3.4				
15x9cm Ground Plane Centre Electrical									
Band	Frequency (MHz)	Setup	Efficiency (%)	Average Gain (dB)	Peak Gain (dBi)	Impedance	Max Power Input	Polarization	Radiation Pattern
2.4GHz Wi-Fi	2400~2500	Straight	55.5	-2.6	4.7	50Ω	10W	Linear	Omnidirectional
		90° Bent	41.6	-3.8	3.5				
5.8GHz Wi-Fi	5150~5850	Straight	51.5	-2.9	2				
		90° Bent	47.2	-3.3	1.3				
7.1GHz Wi-Fi 6	5925~7125	Straight	46.8	-3.3	2.6				
		90° Bent	46.3	-3.4	2.2				
30x30cm Ground Plane Centre Electrical									
Band	Frequency (MHz)	Setup	Efficiency (%)	Average Gain (dB)	Peak Gain (dBi)	Impedance	Max Power Input	Polarization	Radiation Pattern
2.4GHz Wi-Fi	2400~2500	Straight	69.5	-1.6	3.9	50Ω	10W	Linear	Omnidirectional
		90° Bent	62.9	-2	3.6				
5.8GHz Wi-Fi	5150~5850	Straight	72.9	-1.4	6.4				
		90° Bent	75.8	-1.2	5.6				
7.1GHz Wi-Fi 6	5925~7125	Straight	68.9	-1.7	6.1				
		90° Bent	66.2	-1.8	5.2				

30x30cm Ground Plane Edge Electrical									
Band	Frequency (MHz)	Setup	Efficiency (%)	Average Gain (dB)	Peak Gain (dBi)	Impedance	Max Power Input	Polarization	Radiation Pattern
2.4GHz Wi-Fi	2400~2500	Straight	48.4	-3.2	3.3	50Ω	2W	Linear	Omnidirectional
		90° Bent	41.5	-3.8	3				
5.8GHz Wi-Fi	5150~5850	Straight	38.4	-4.2	5.1				
		90° Bent	35.5	-4.5	5.2				
7.1GHz Wi-Fi 6	5925~7125	Straight	27	-5.7	4.4				
		90° Bent	25.7	-5.9	4.6				

Mechanical	
Antenna length	62.3mm
Antenna Diameter	10mm
Casing	POM
Connector	RP-SMA(M)
Weight	6g
Recommended Torque for Mounting	0.9N·m
Max Torque for Mounting	1.176N·m
Environmental	
Operation Temperature	-40°C ~ + 85°C
Storage Temperature	-40°C ~ + 85°C
Humidity	Non-condensing 65°C 95% RH

3. Antenna Characteristics

3.1 Return Loss – Free Space

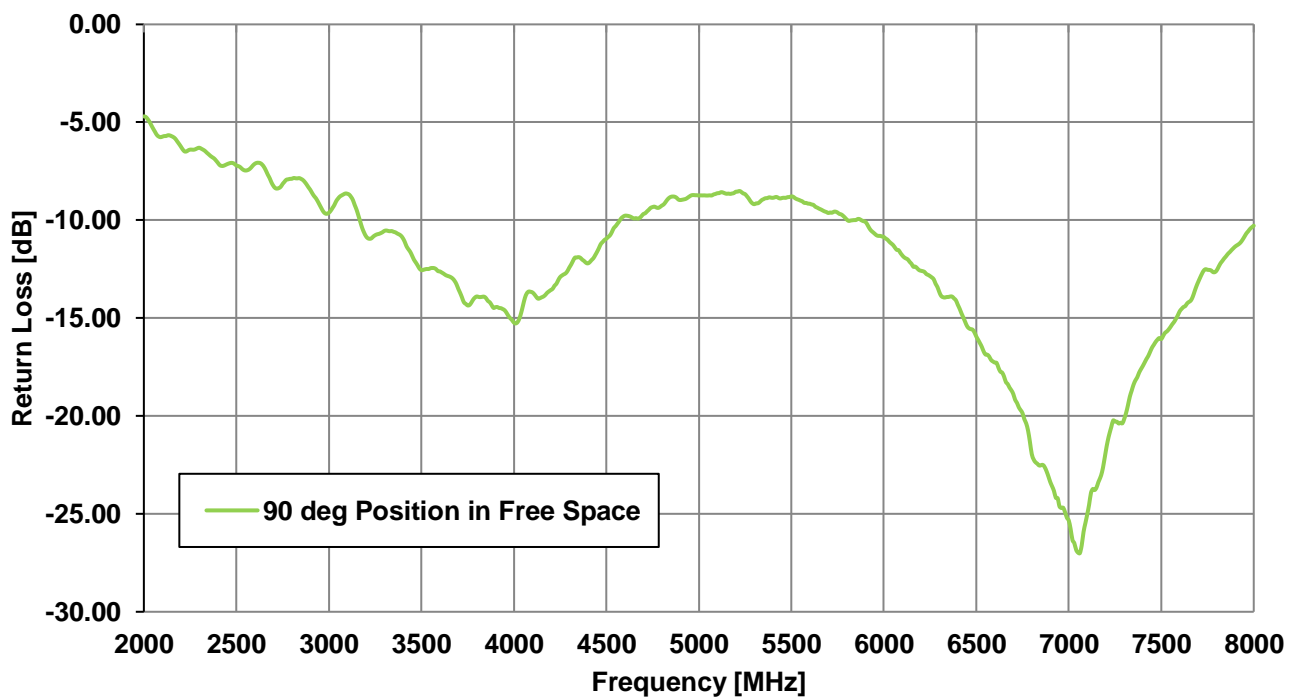

3.2 Efficiency – Free Space

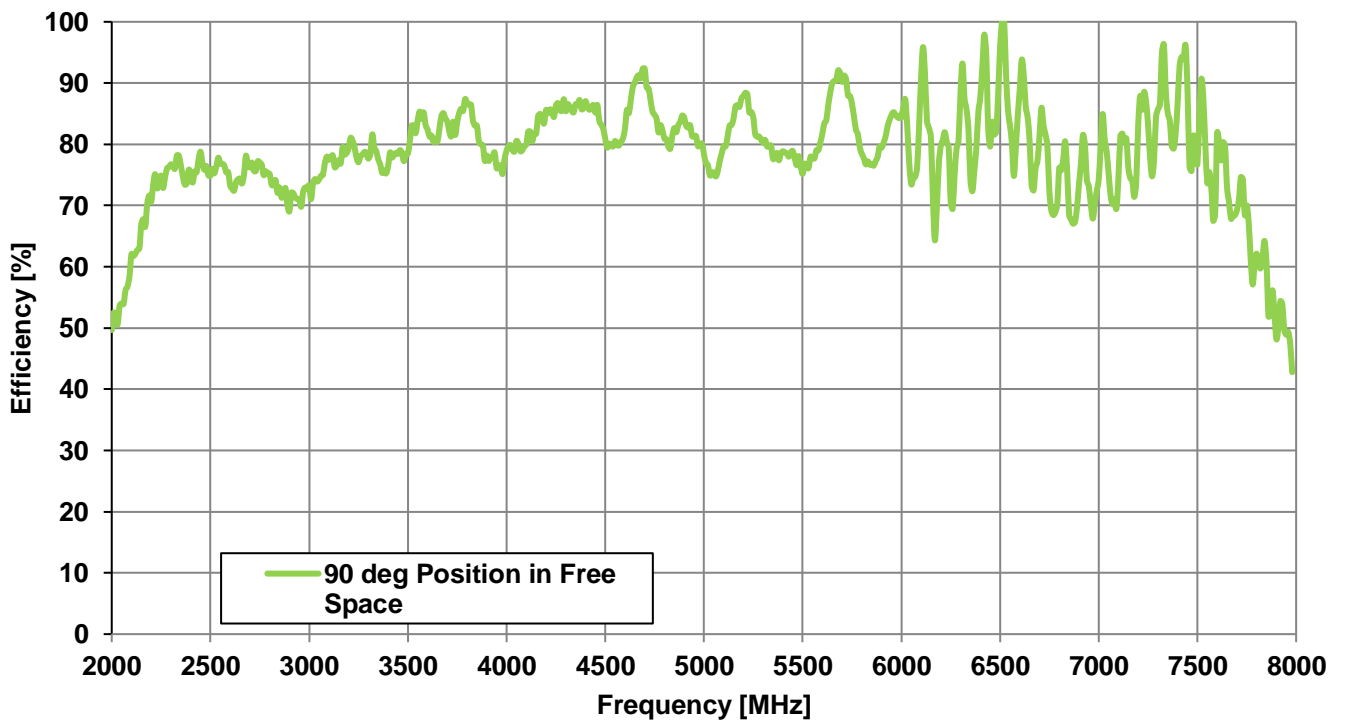
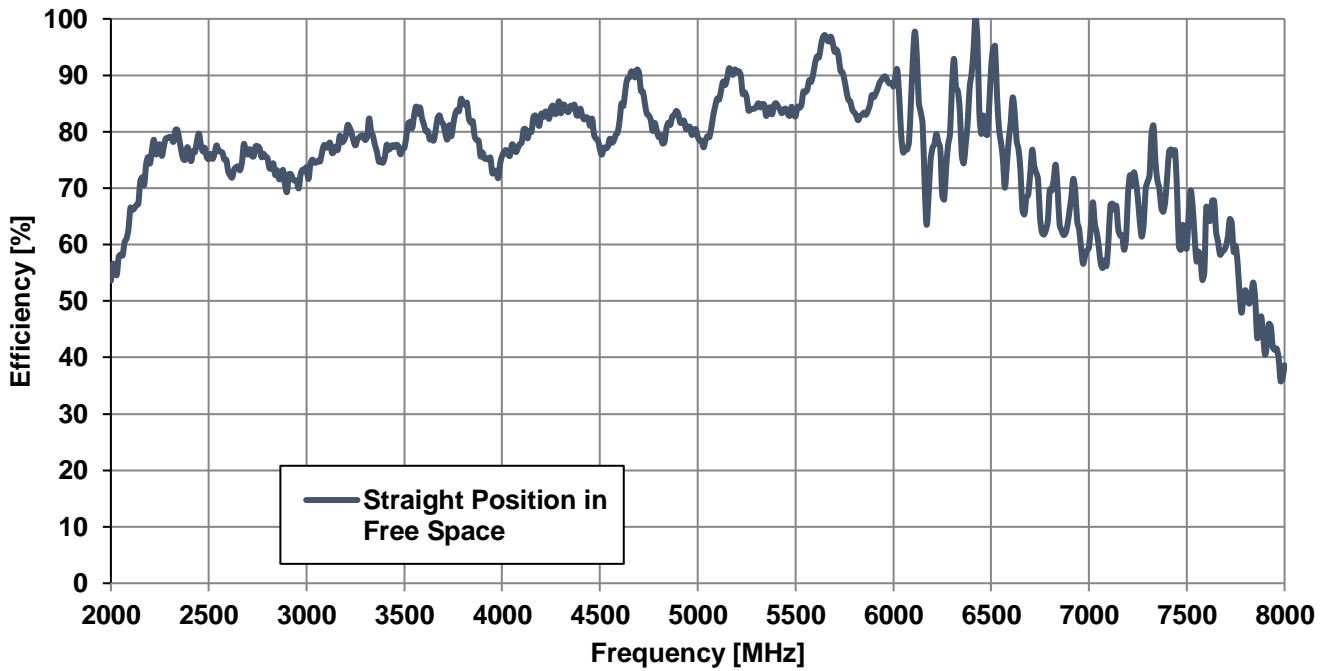

3.3 Peak Gain – Free Space

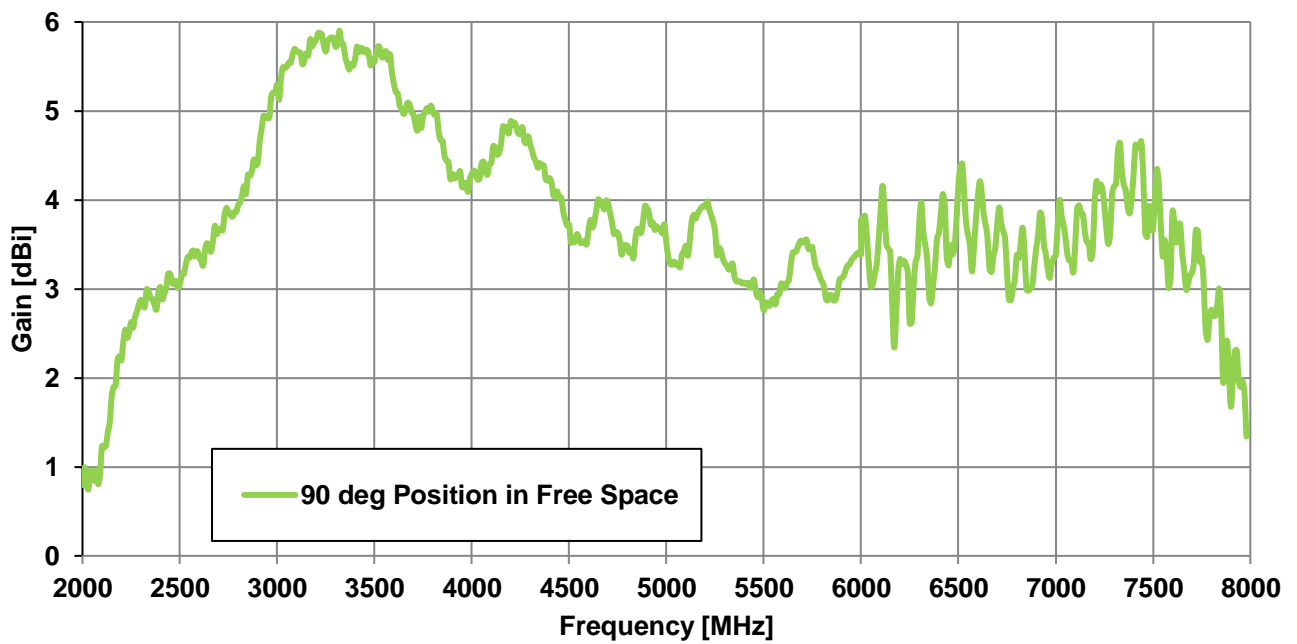
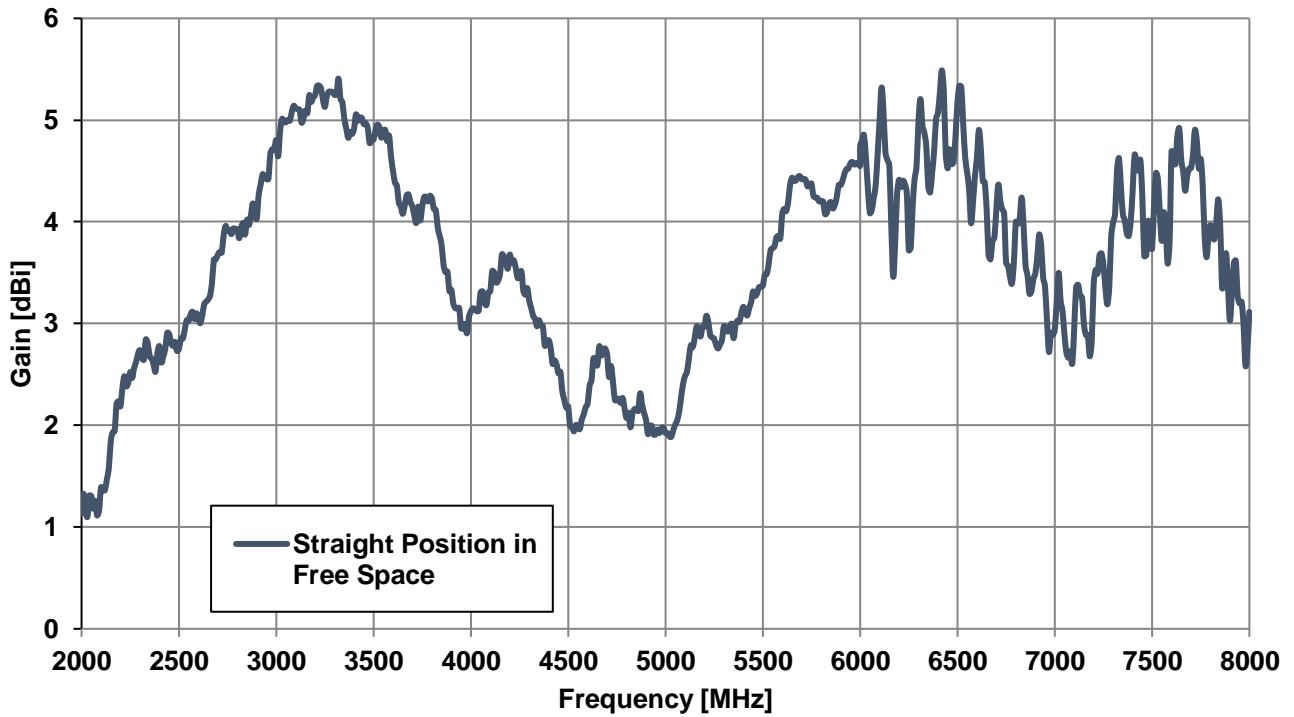

3.4 Average Gain – Free Space

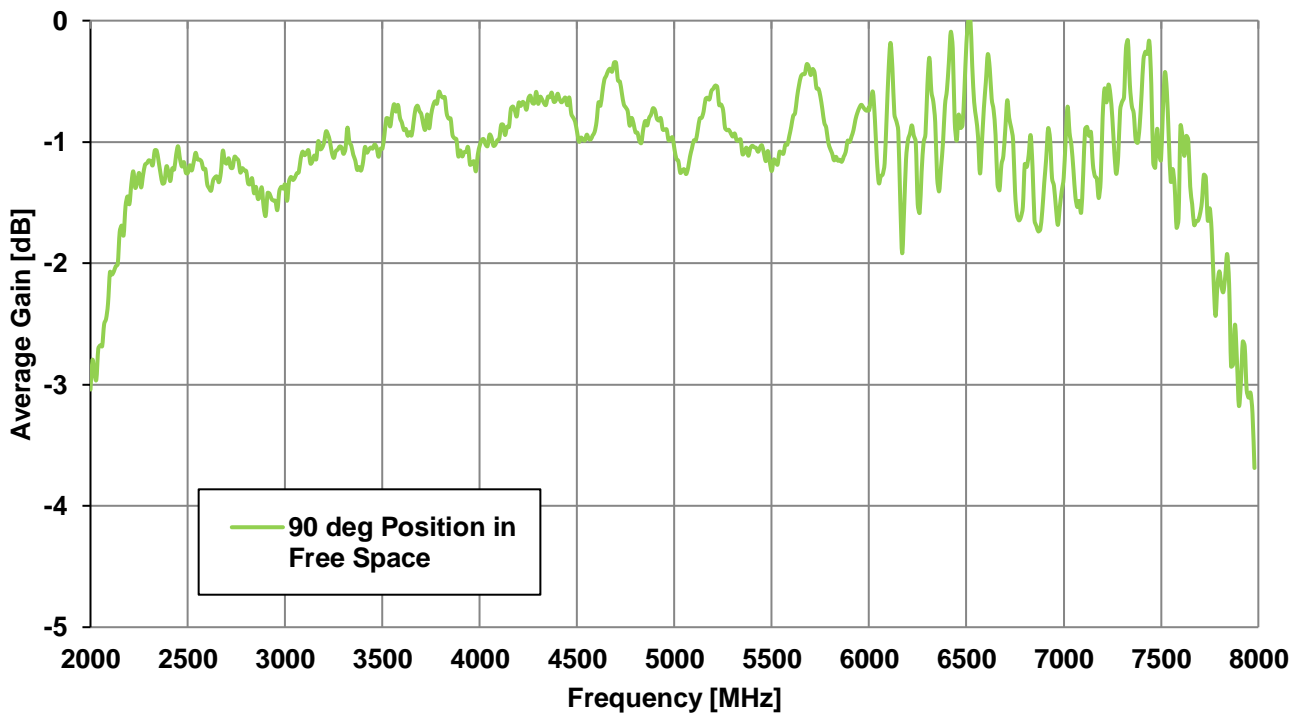
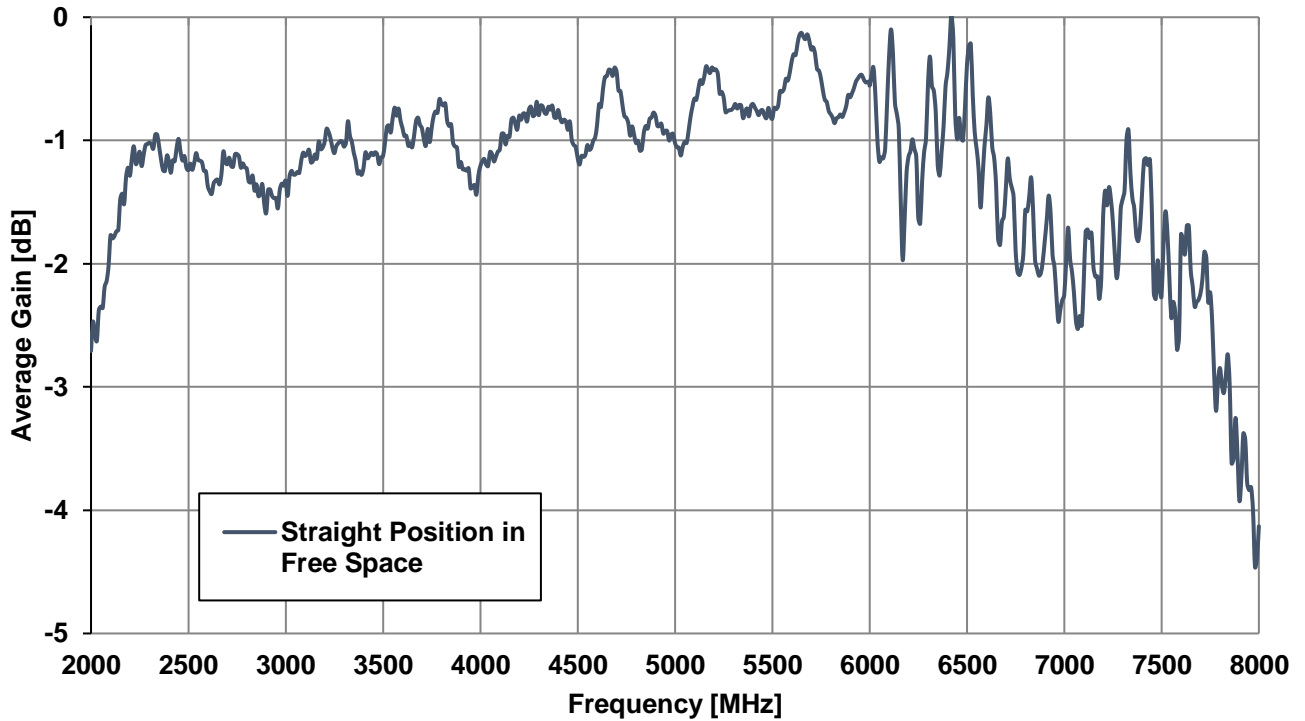

3.5 Efficiency – 30*30cm Ground Plane

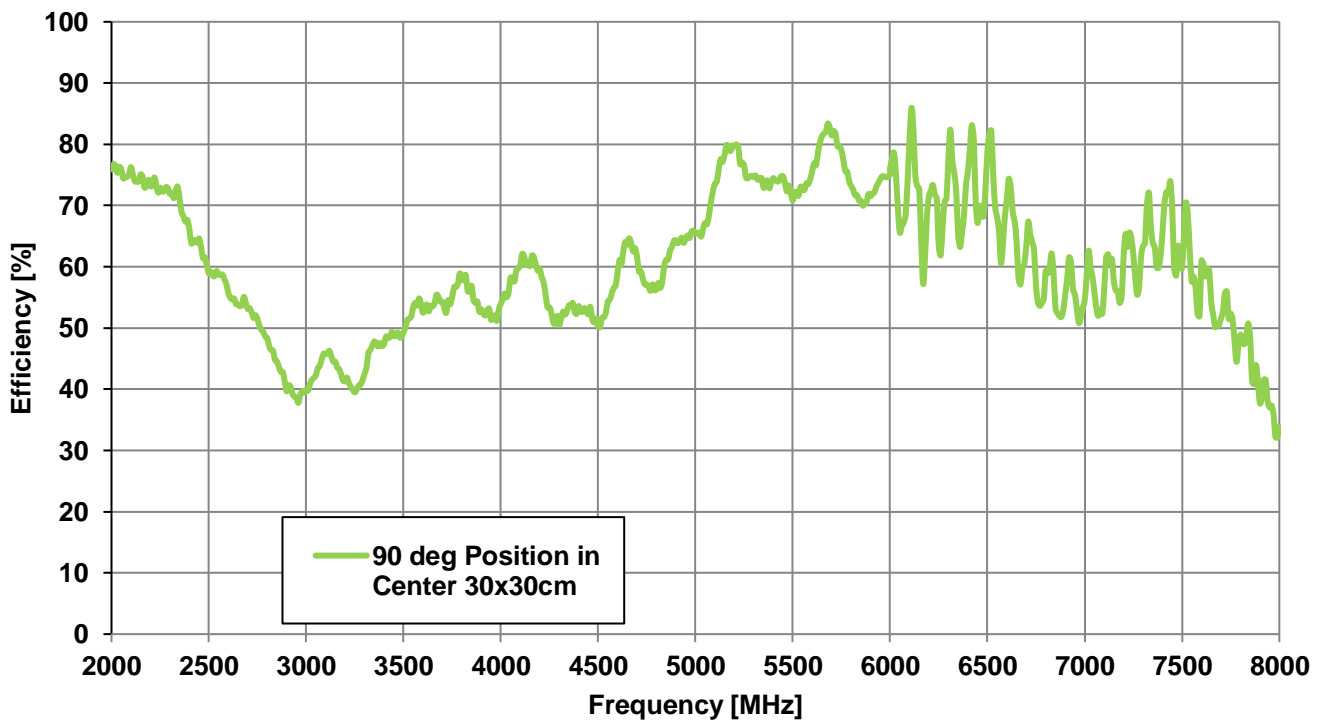
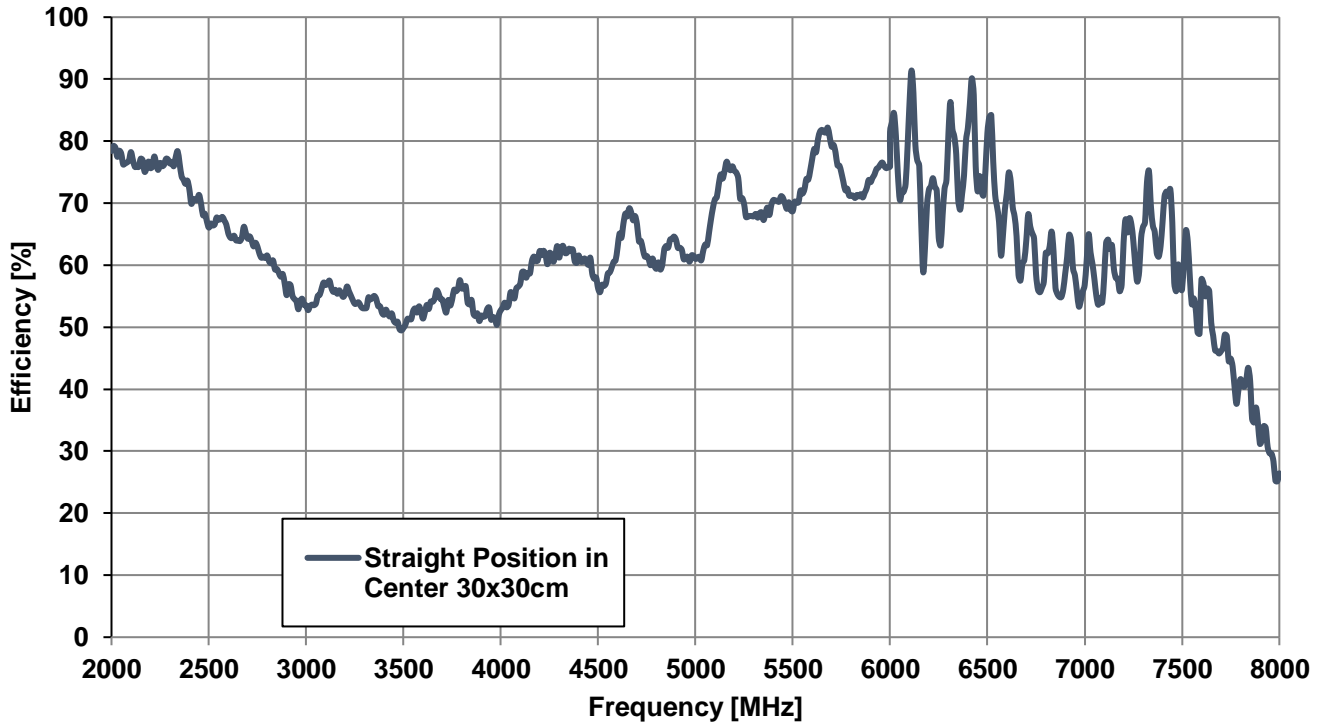

3.6 Peak Gain – 30*30cm Ground Plane

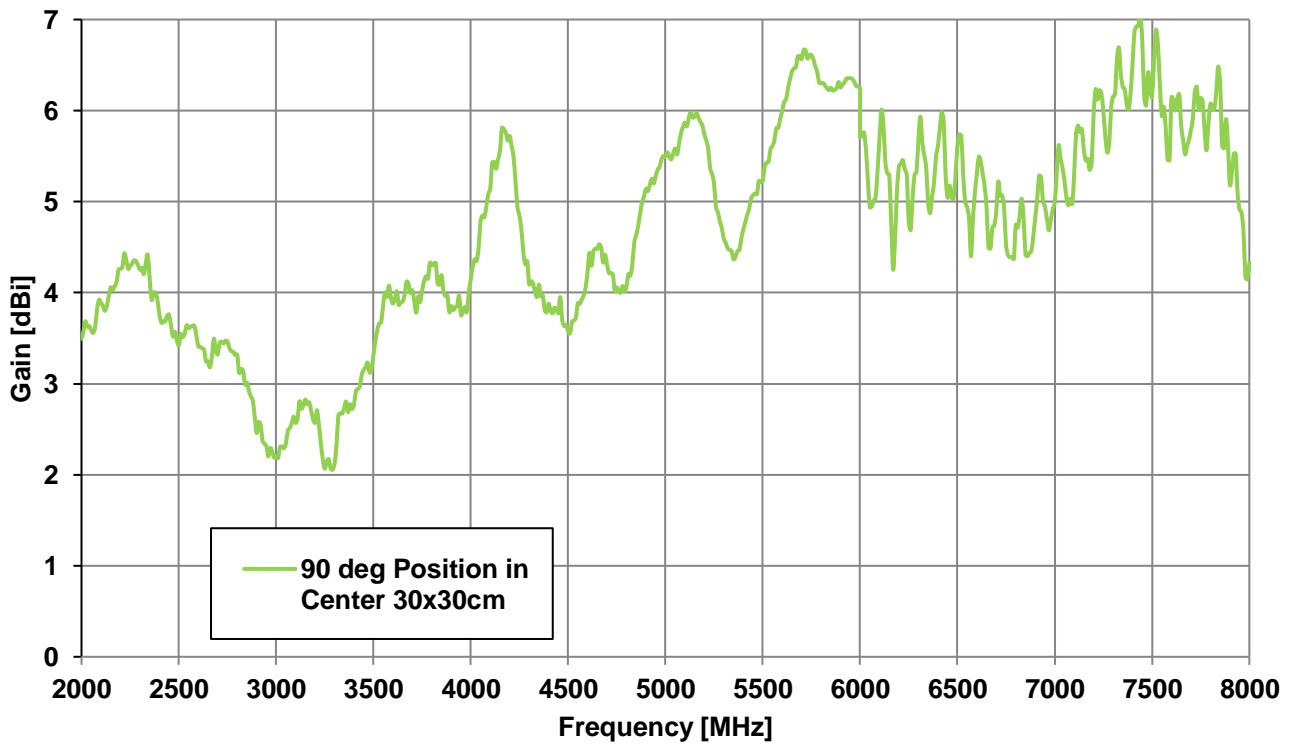
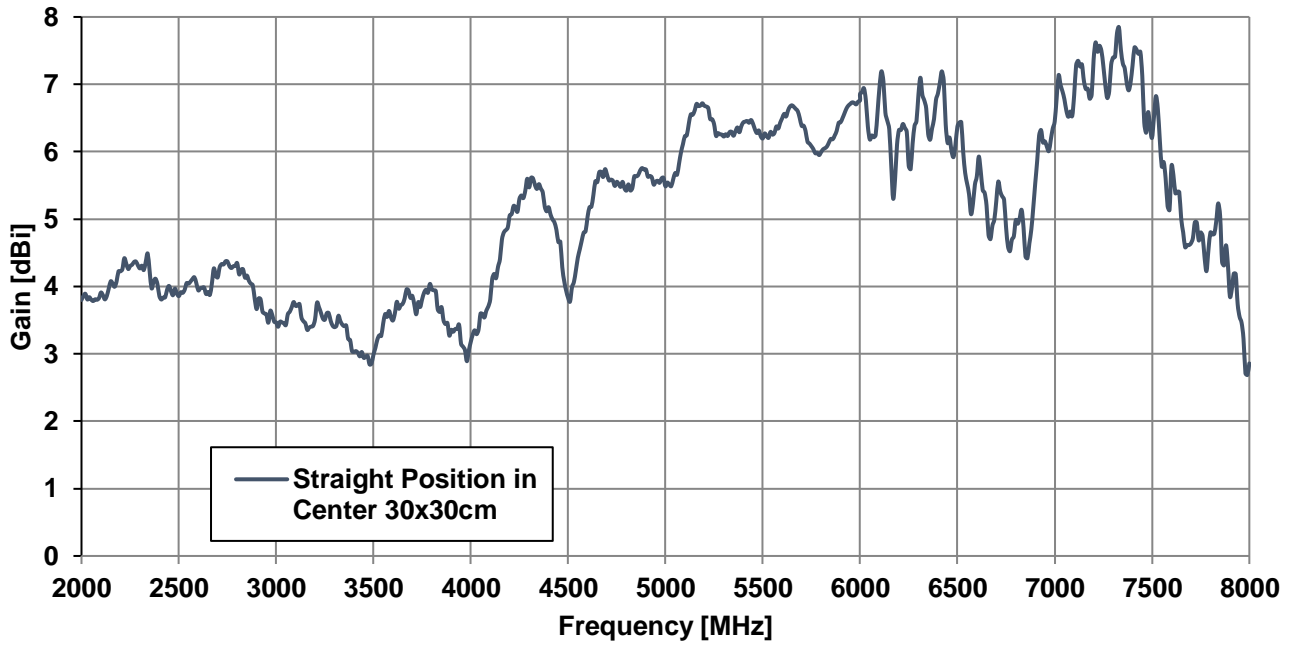

3.7 Average Gain – 30*30cm Ground Plane

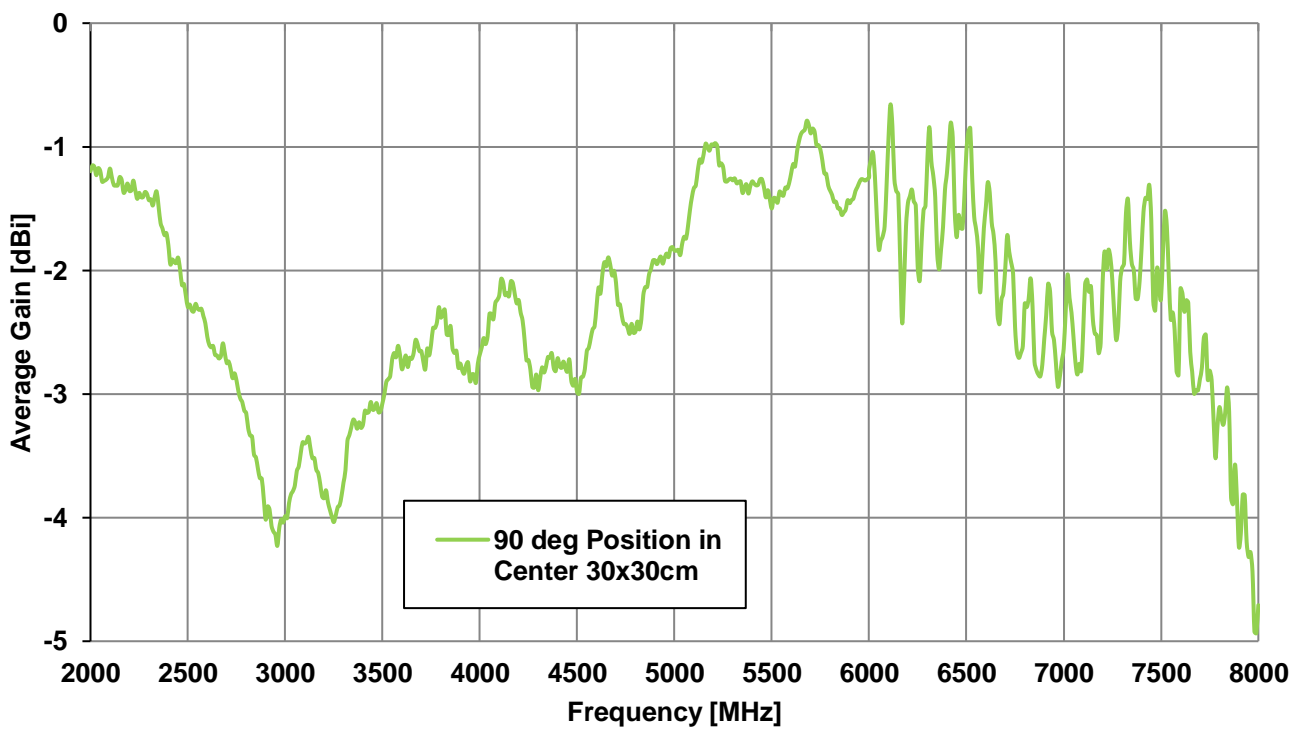
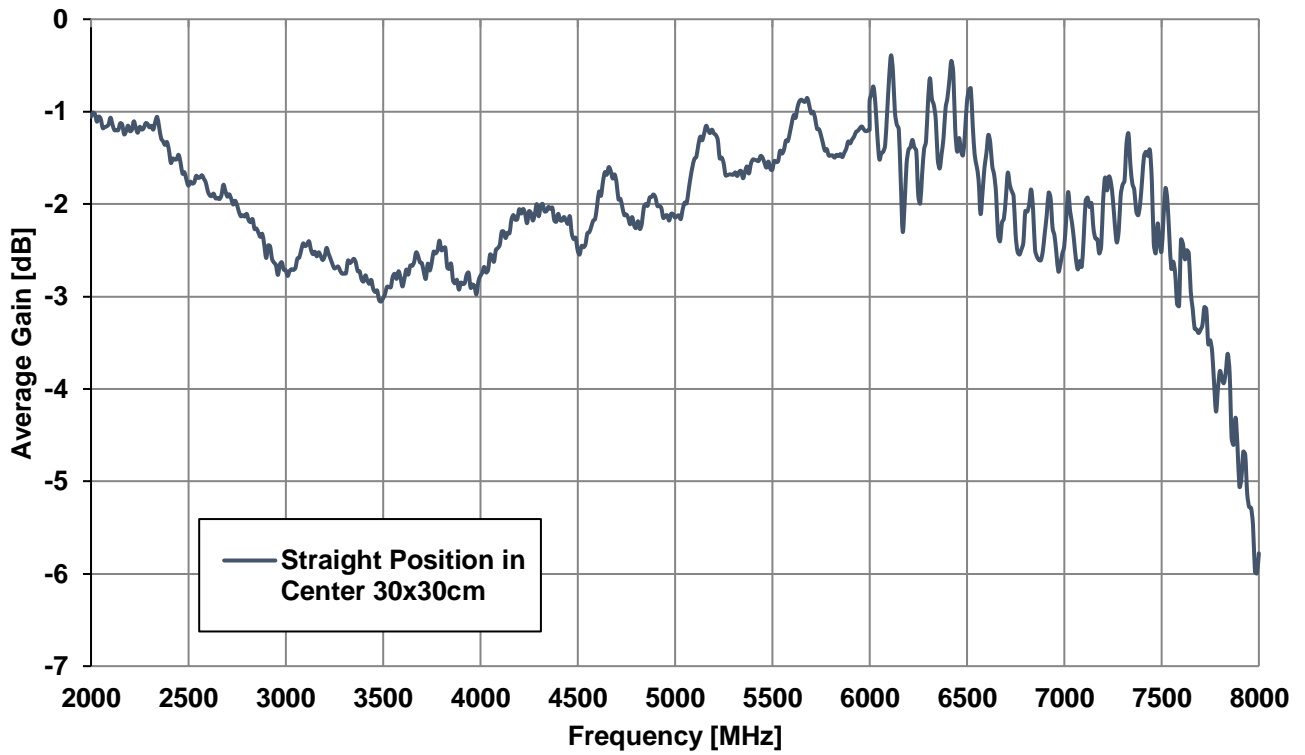

3.8 Return Loss – 30*30cm Ground Plane Edge

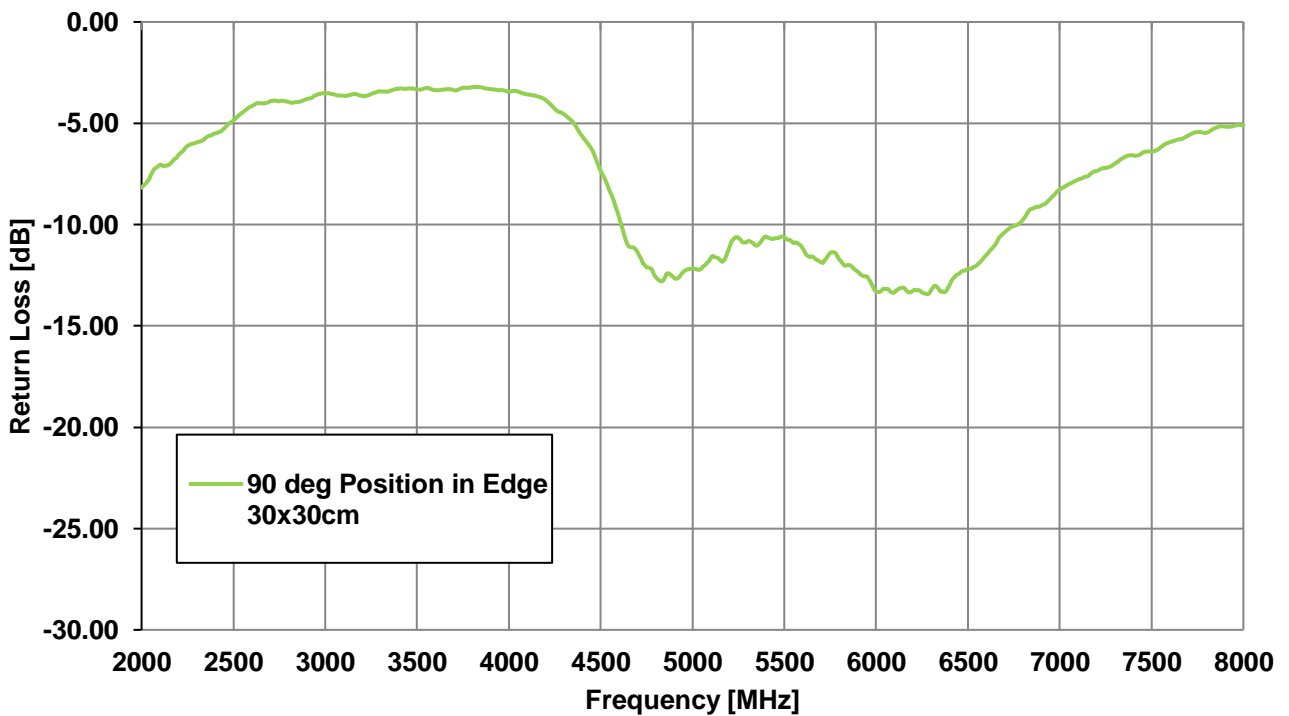
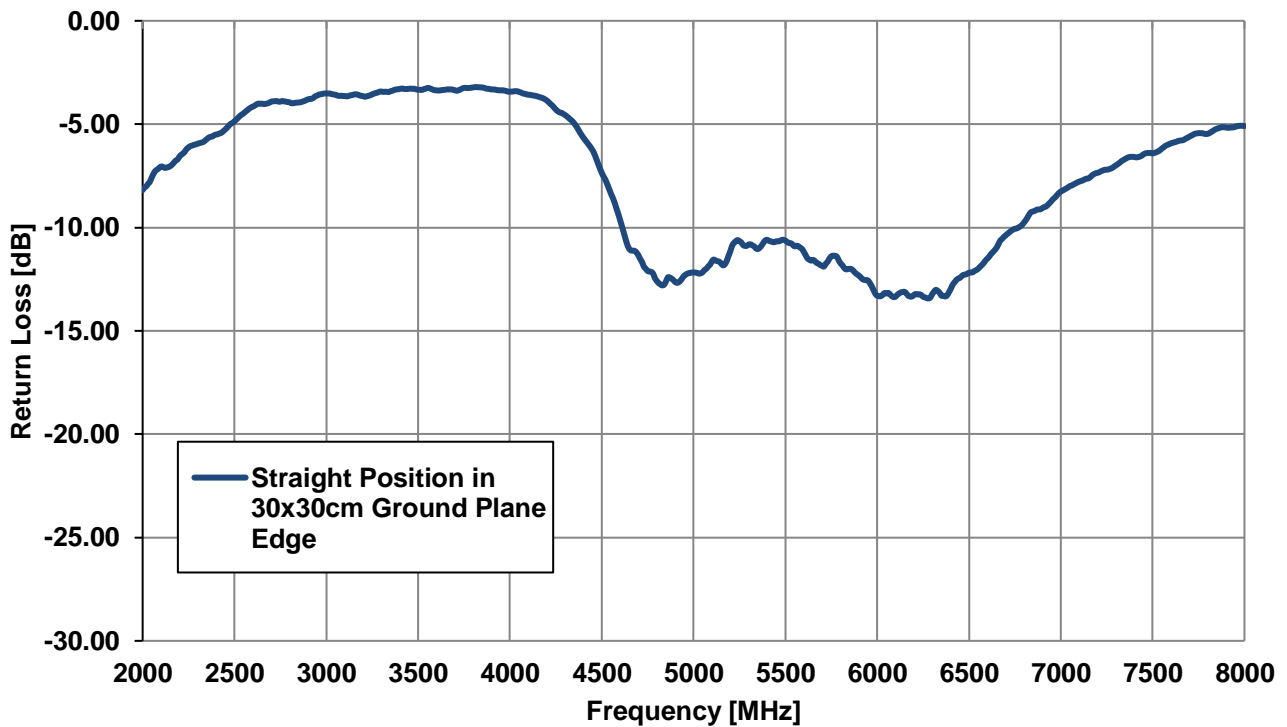

3.9 Efficiency – 30*30cm Ground Plane Edge

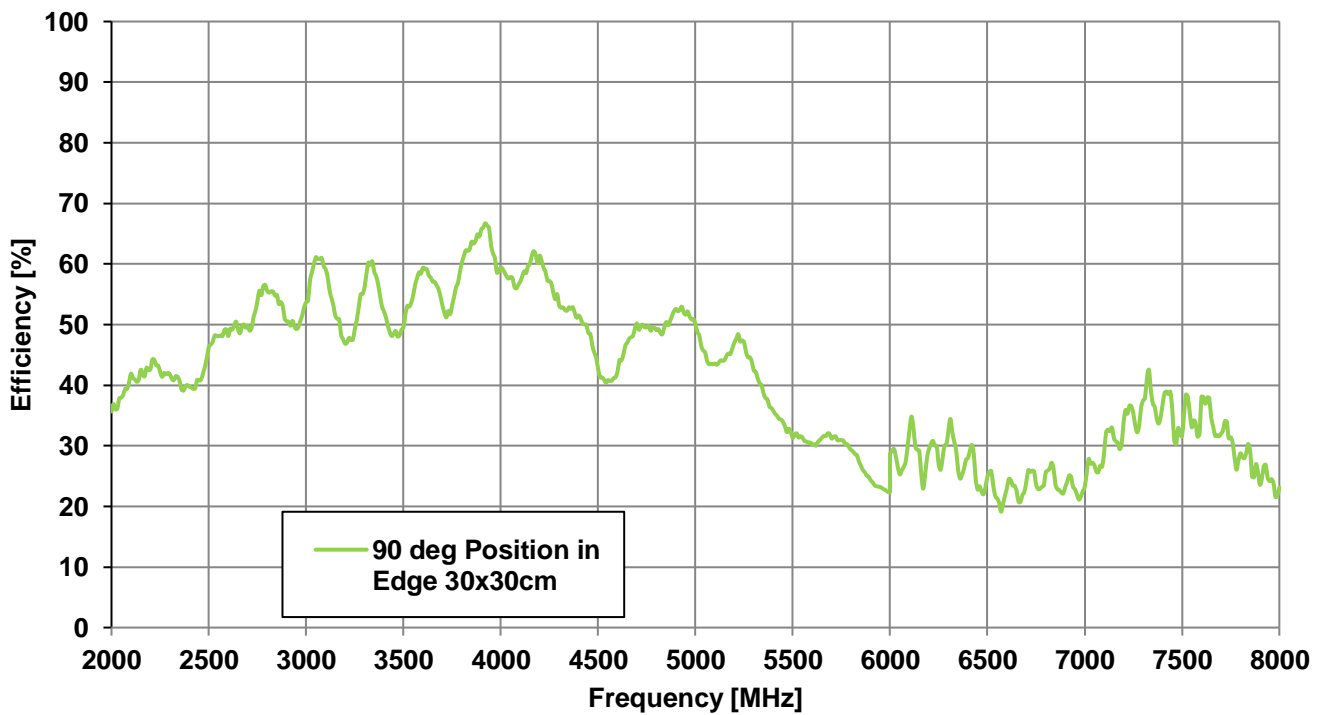
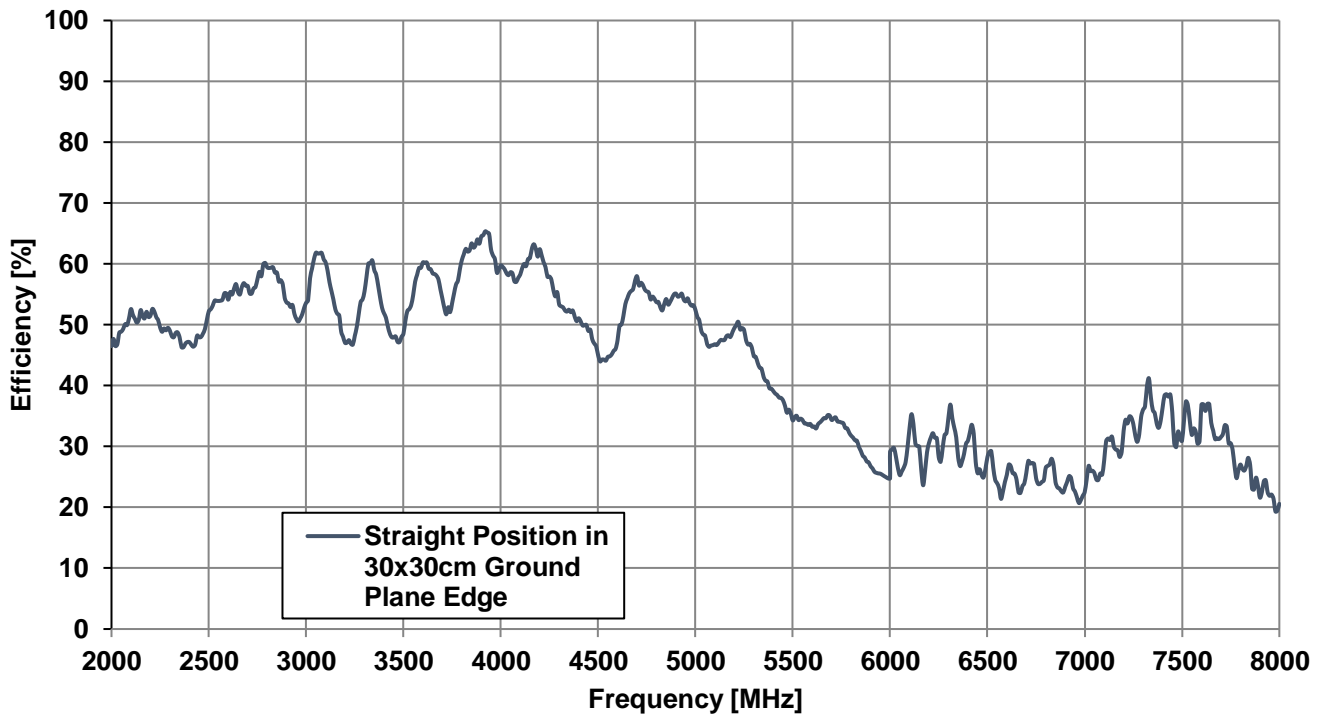

3.10 Peak Gain – 30*30cm Ground Plane Edge

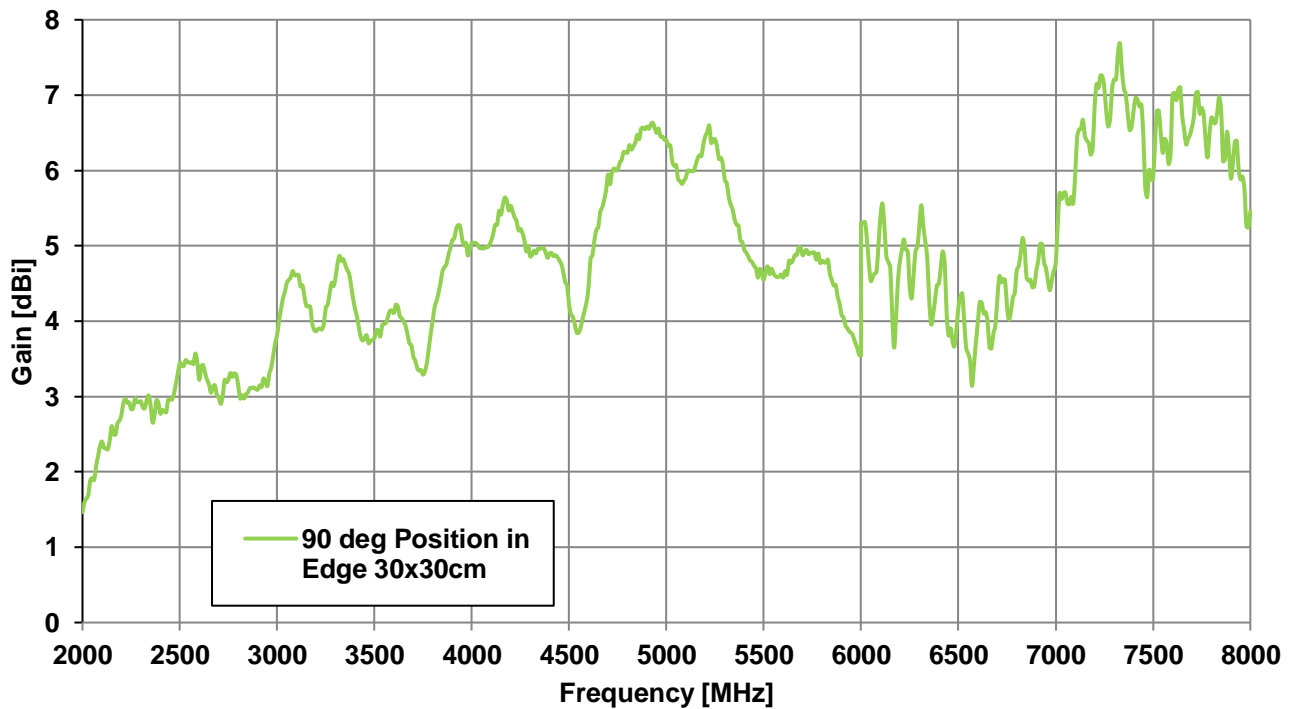
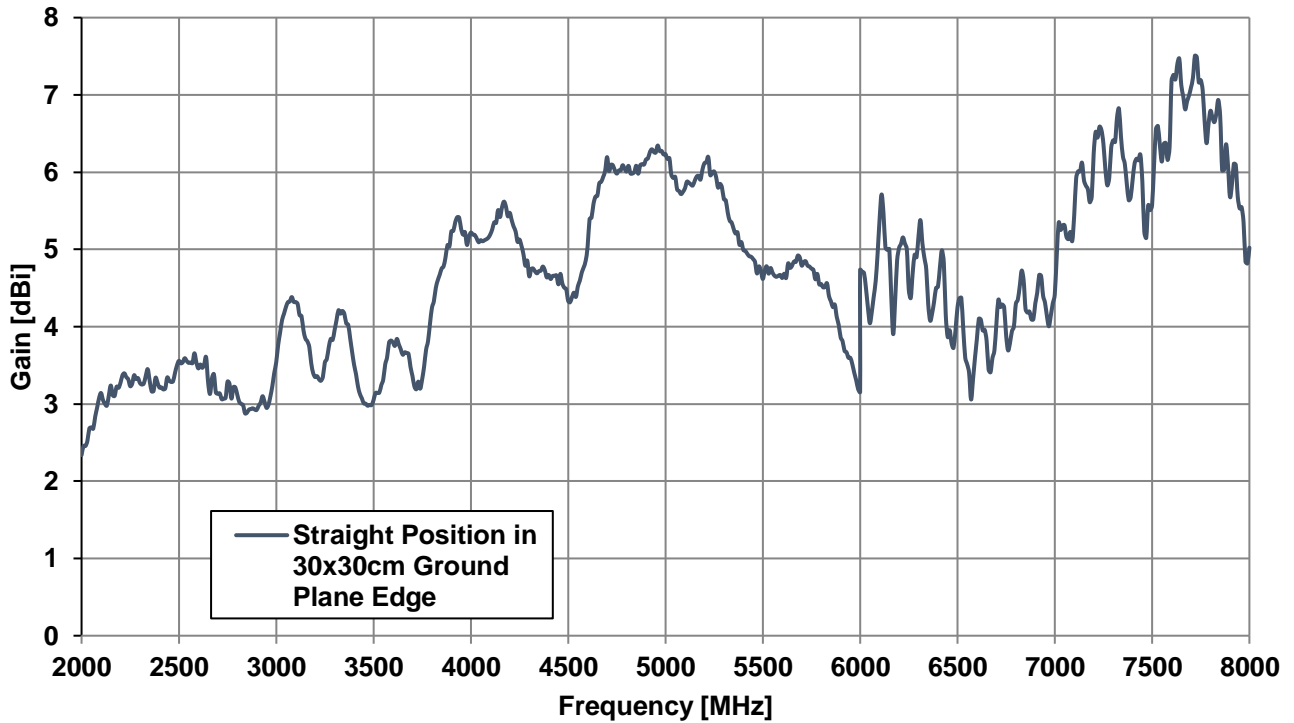

3.11 Average Gain – 30*30cm Ground Plane Edge

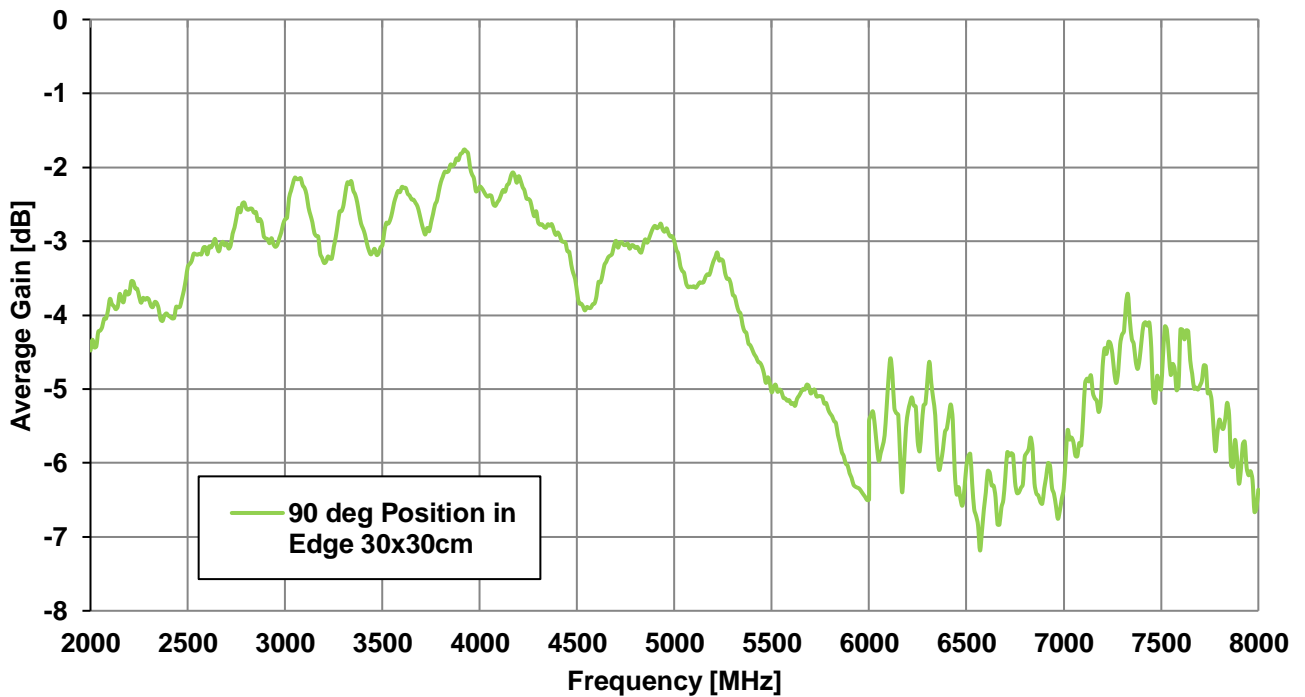
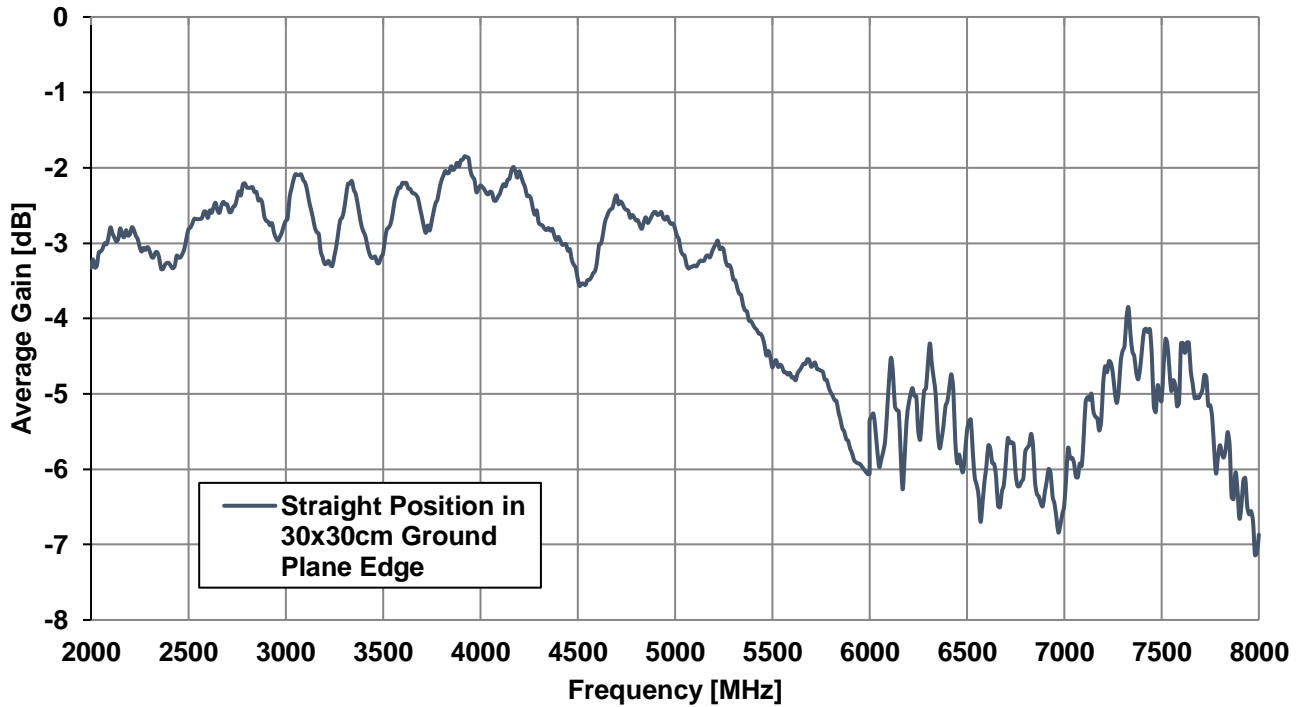

3.12 Return Loss – 15*9cm Ground Plane

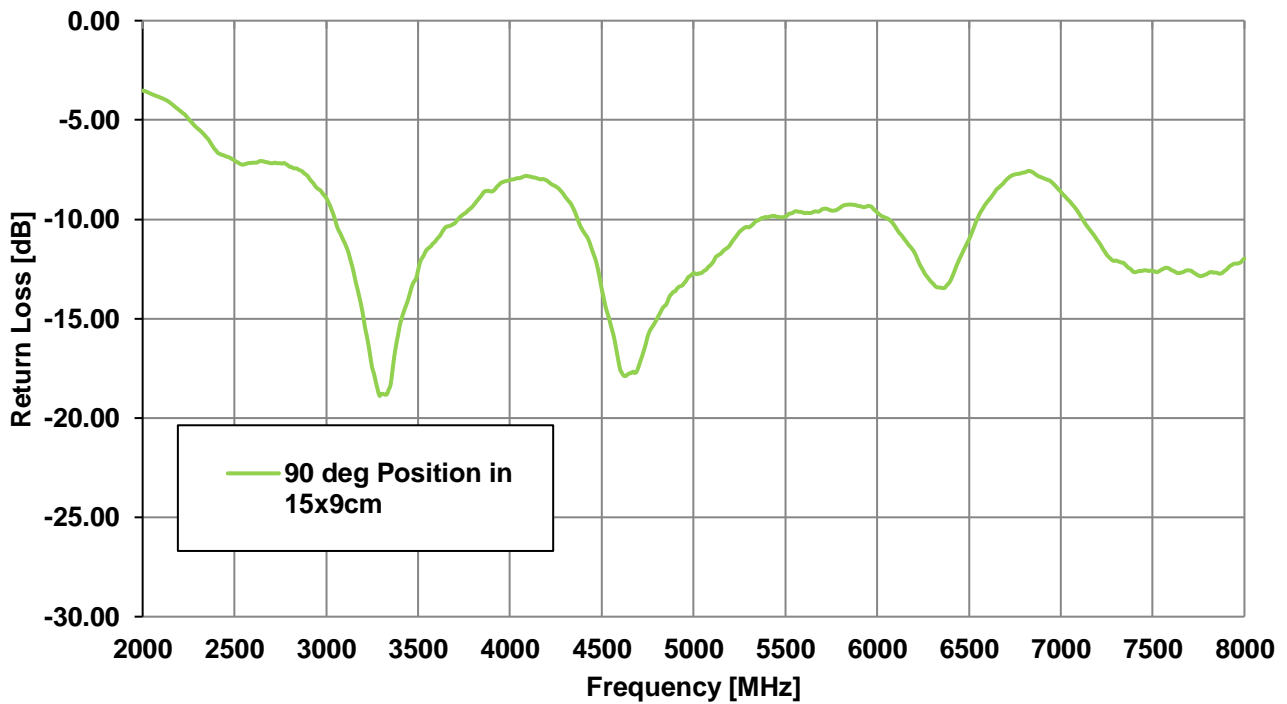
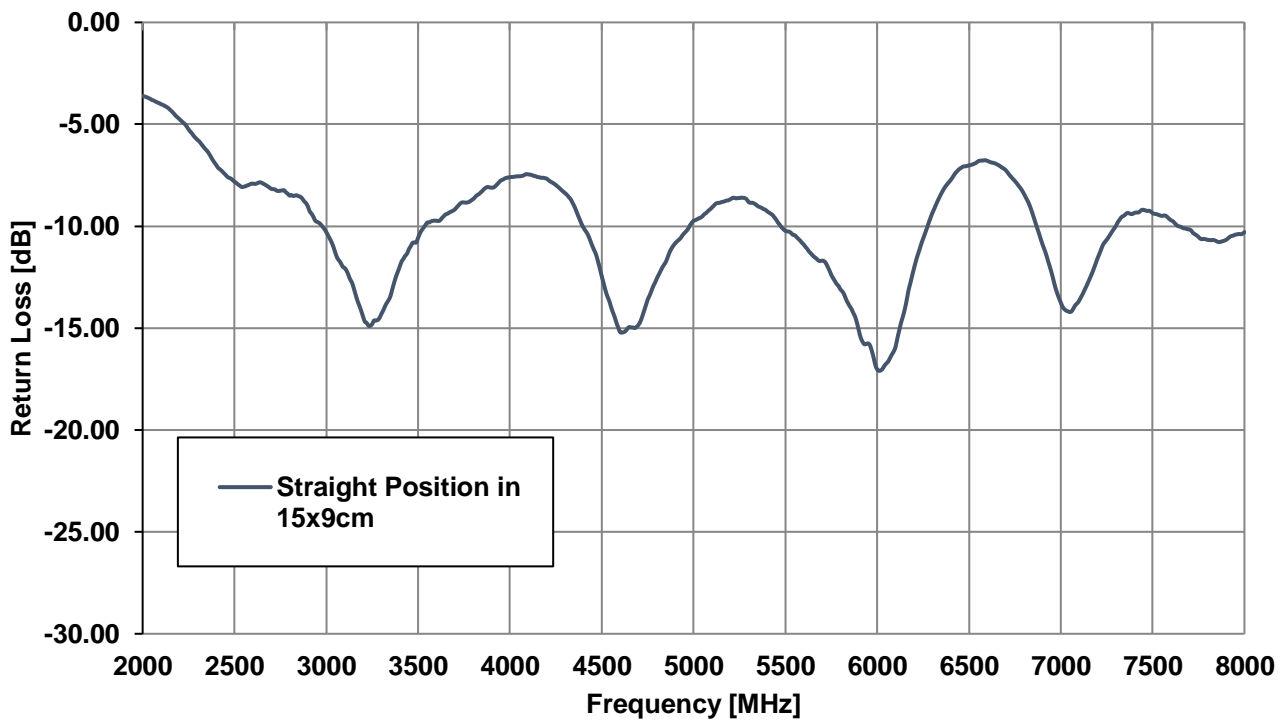

3.13 Efficiency – 15*9cm Ground Plane

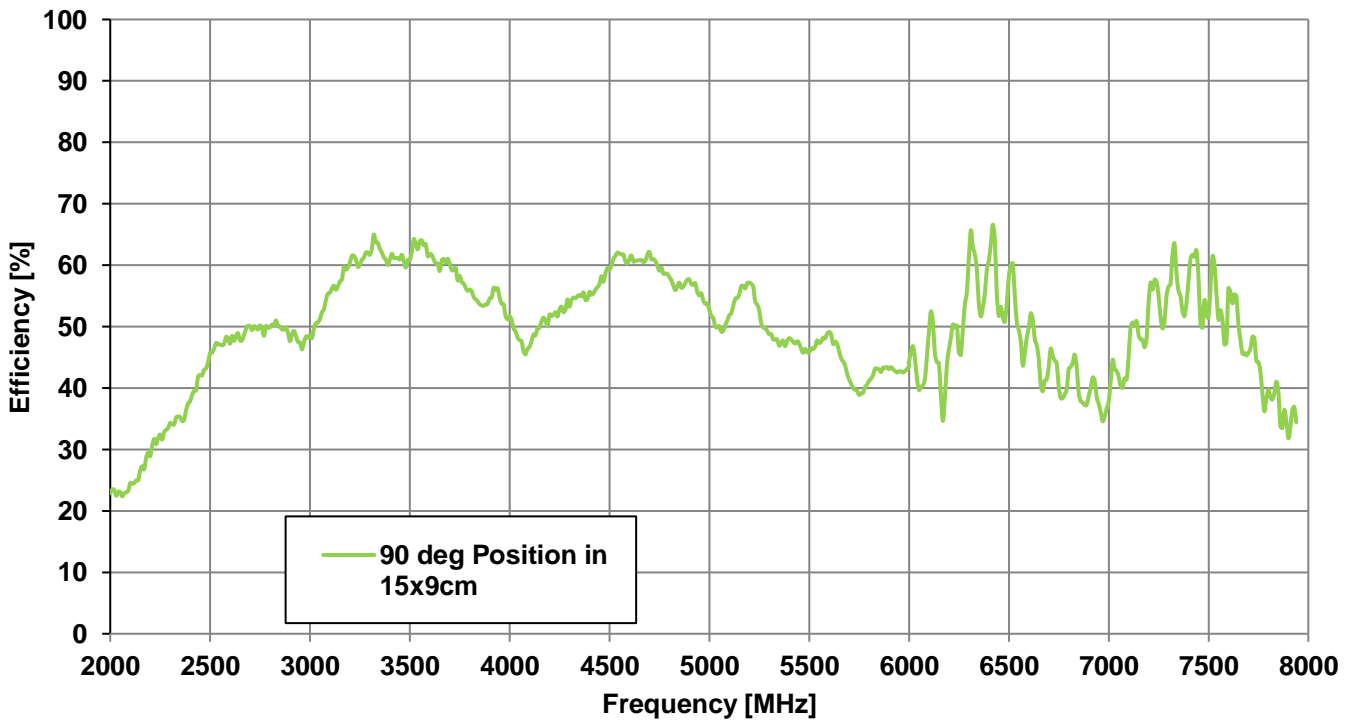
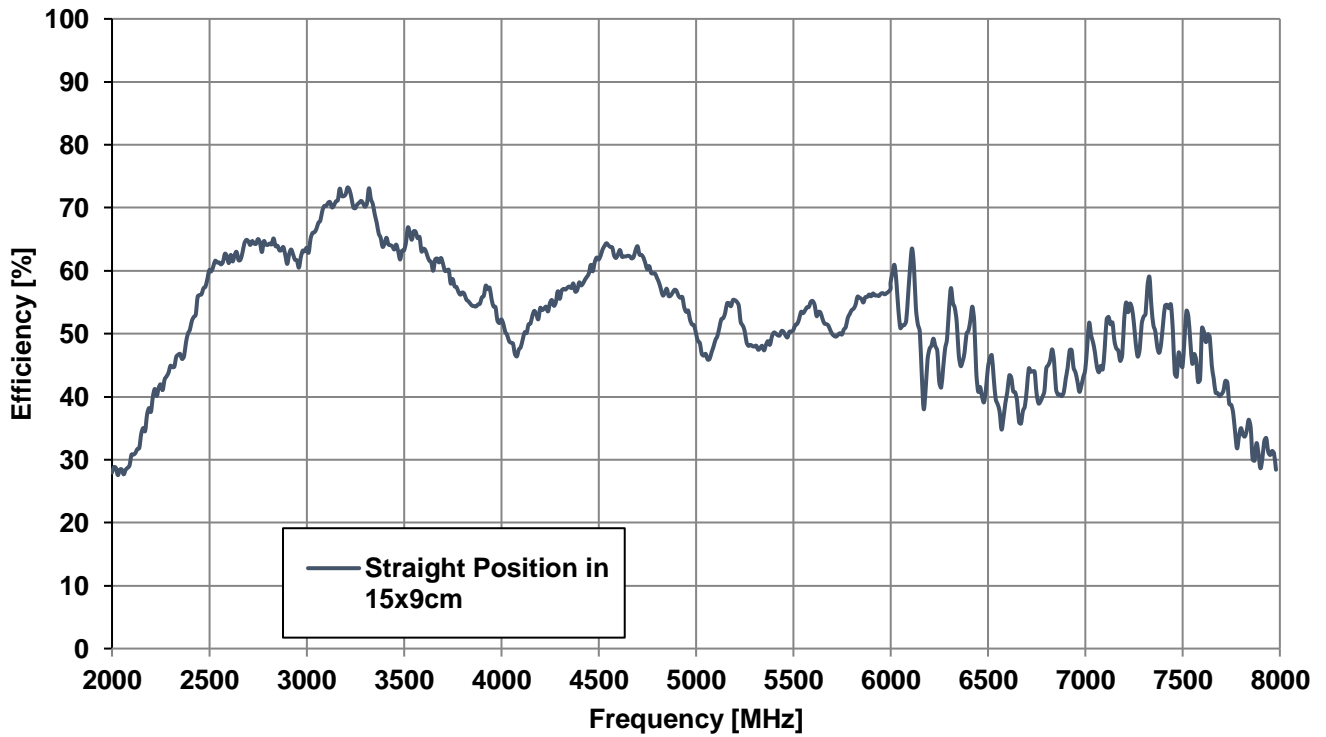

3.14 Peak Gain – 15*9cm Ground Plane

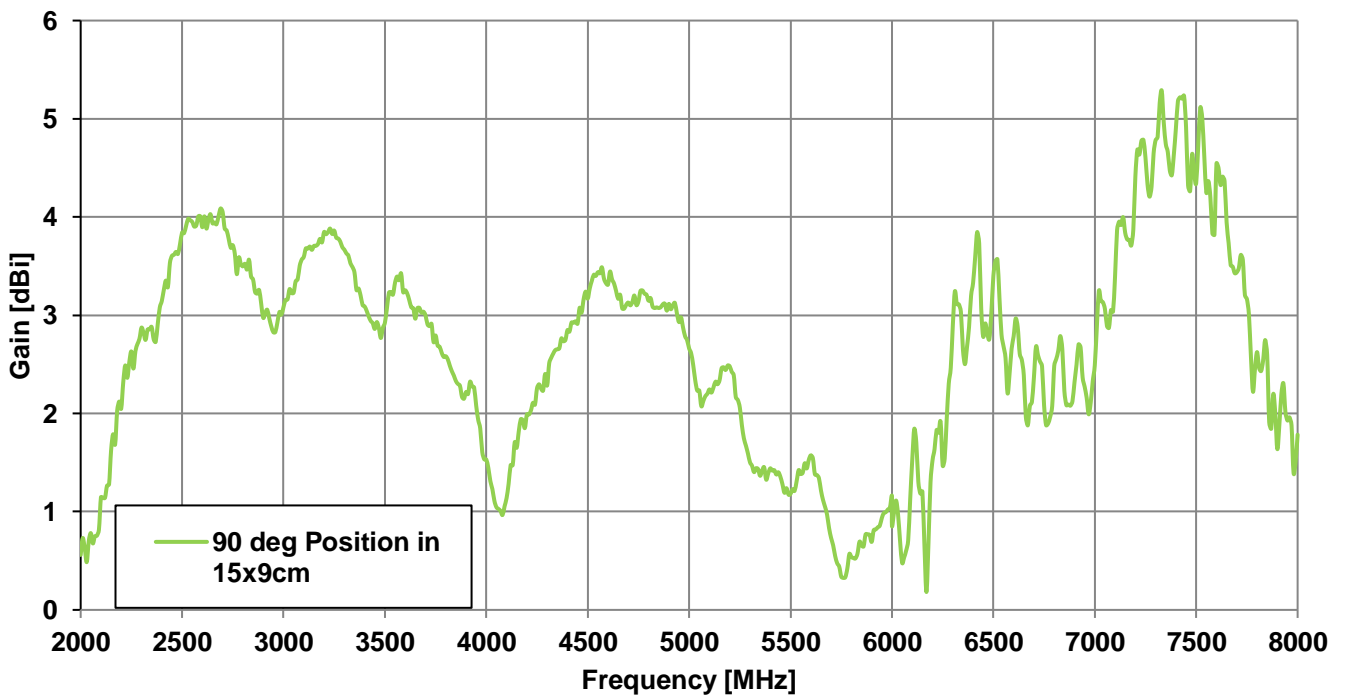
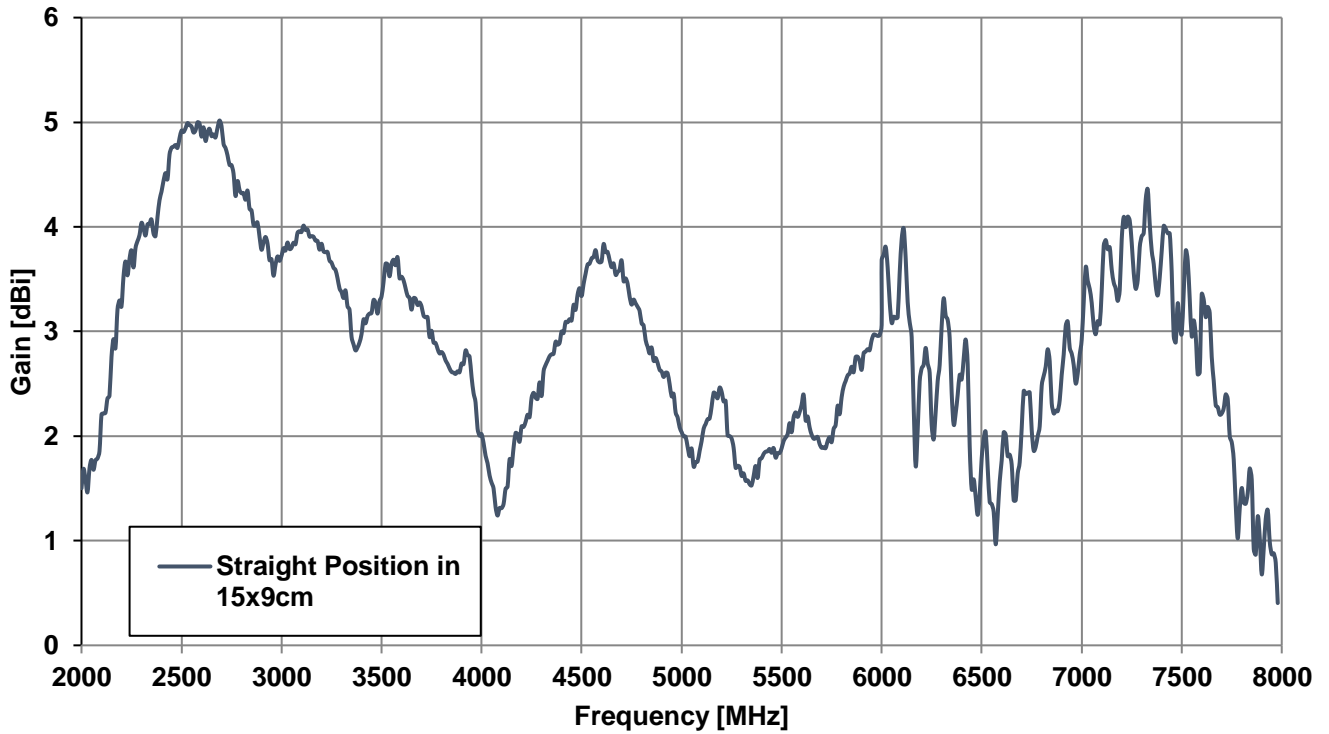

3.15 Average Gain – 15*9cm Ground Plane

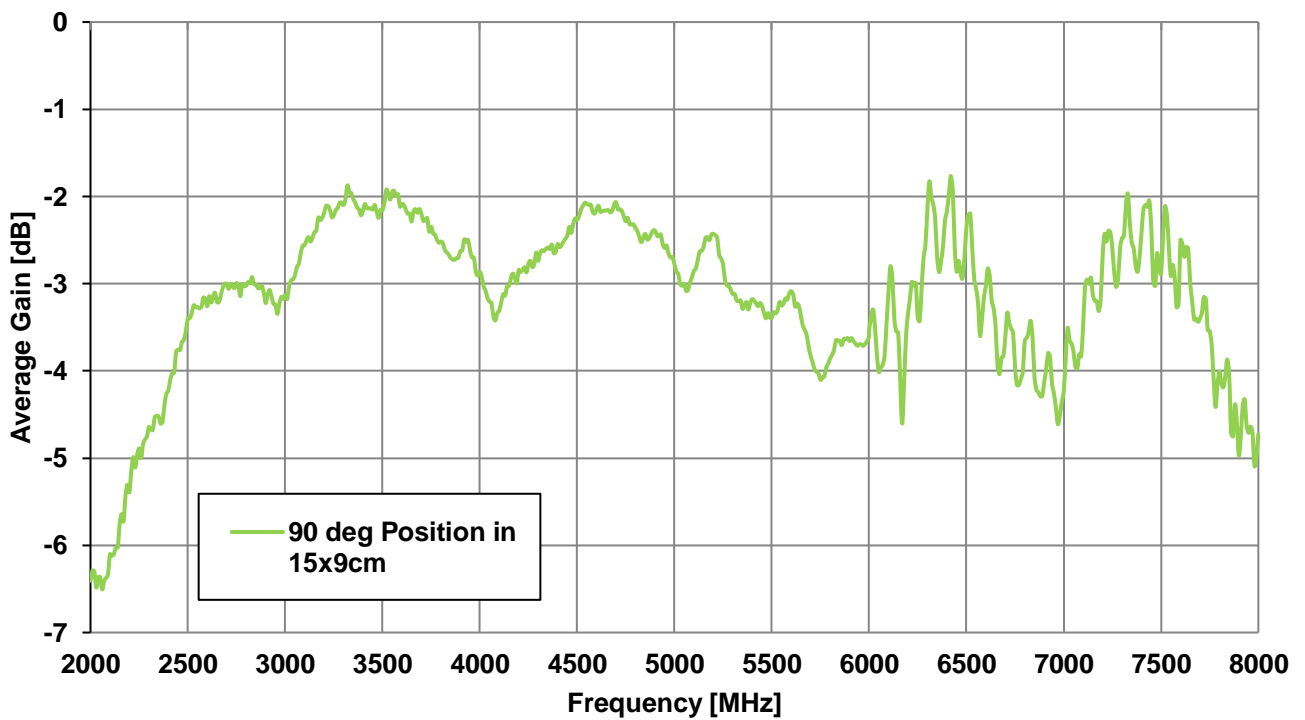
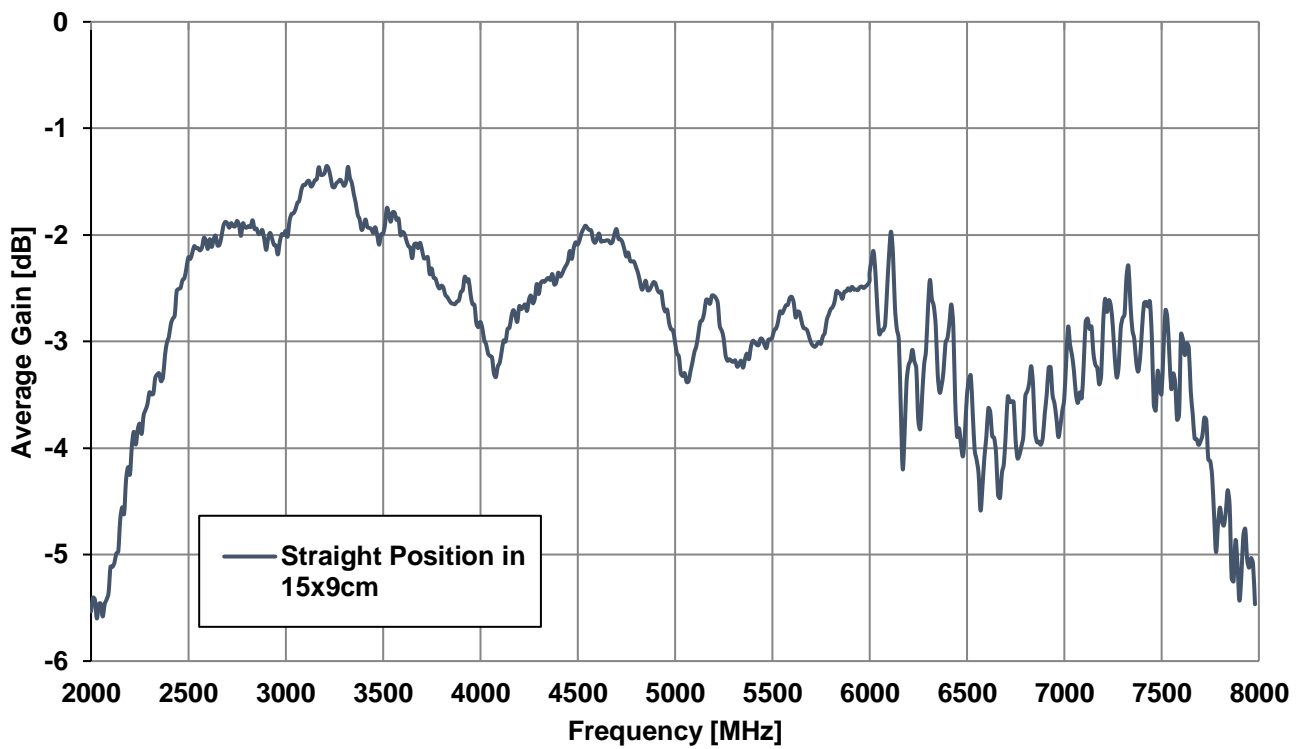

4. Radiation Patterns

4.1 Test Setup – Straight

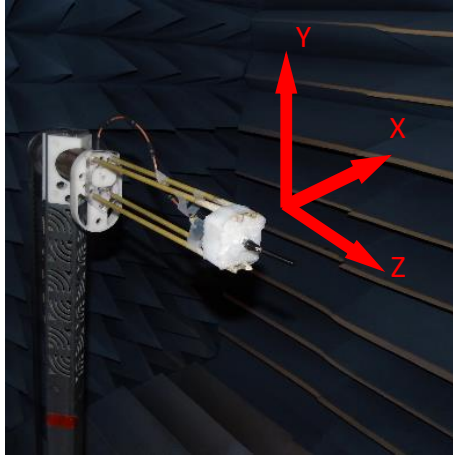

Free space

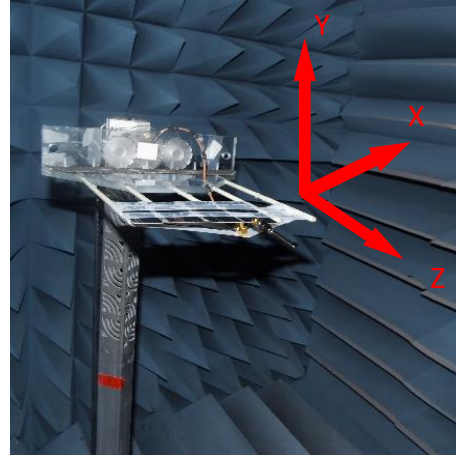

15x9cm ground plane



30x30cm metal ground center



30x30cm metal ground edge

4.2 Test Setup – Bent (90°)



Free space



15x9cm ground plane

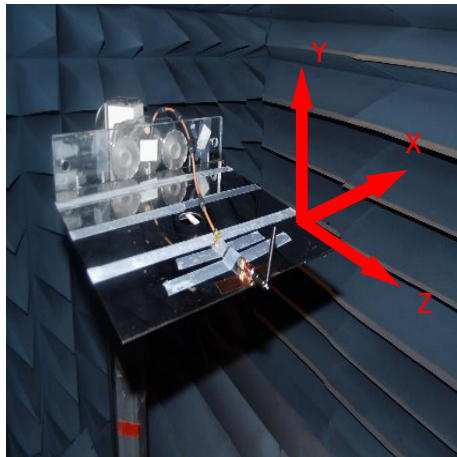

30x30cm metal ground center

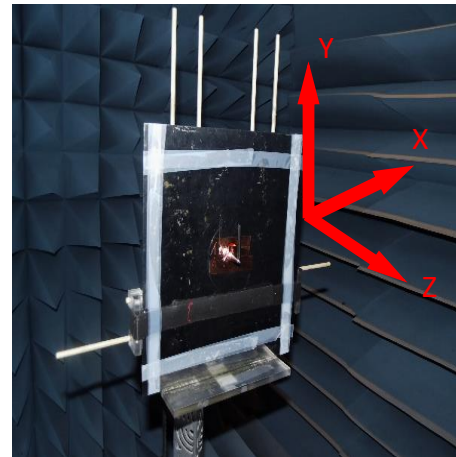

30x30cm metal ground edge

4.3 Straight Free Space - 2D Radiation Patterns

XY Plane

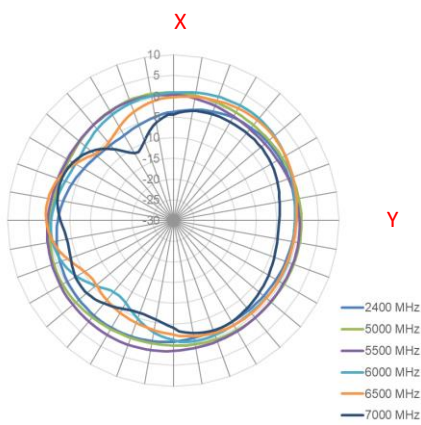

XZ Plane

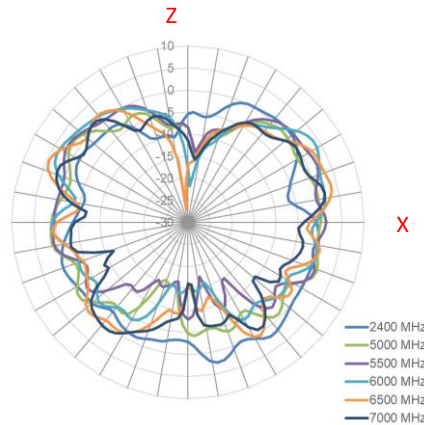

YZ Plane

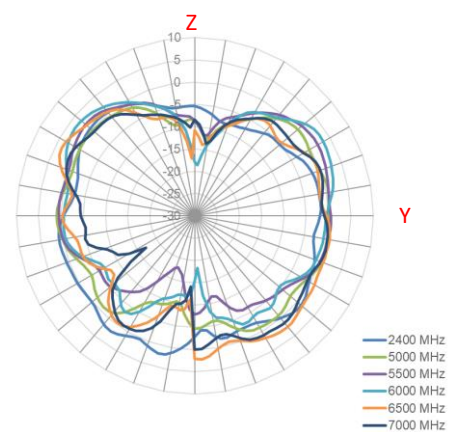

4.4 Bent 90° Free Space - 2D Radiation Patterns

XY Plane

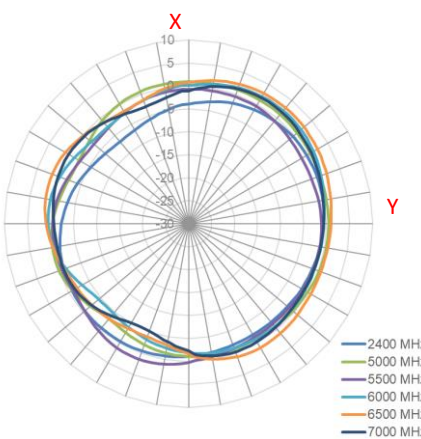

XZ Plane

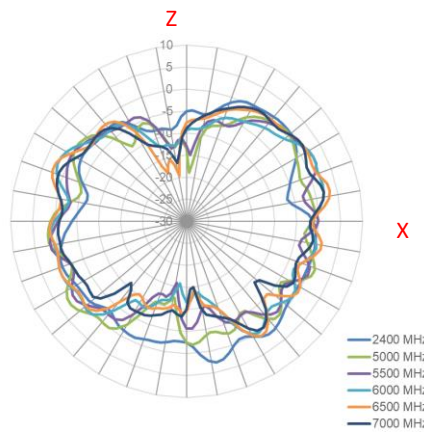

YZ Plane

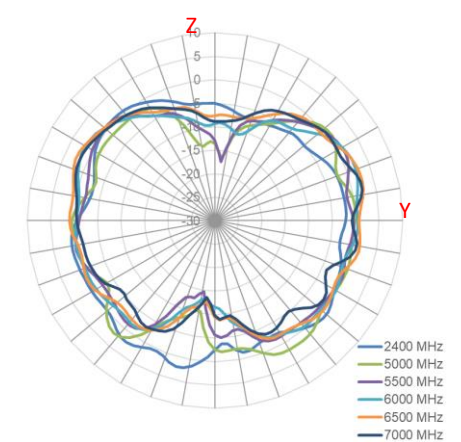

4.5 Straight 30*30cm Center Ground Plane - 2D Radiation Patterns

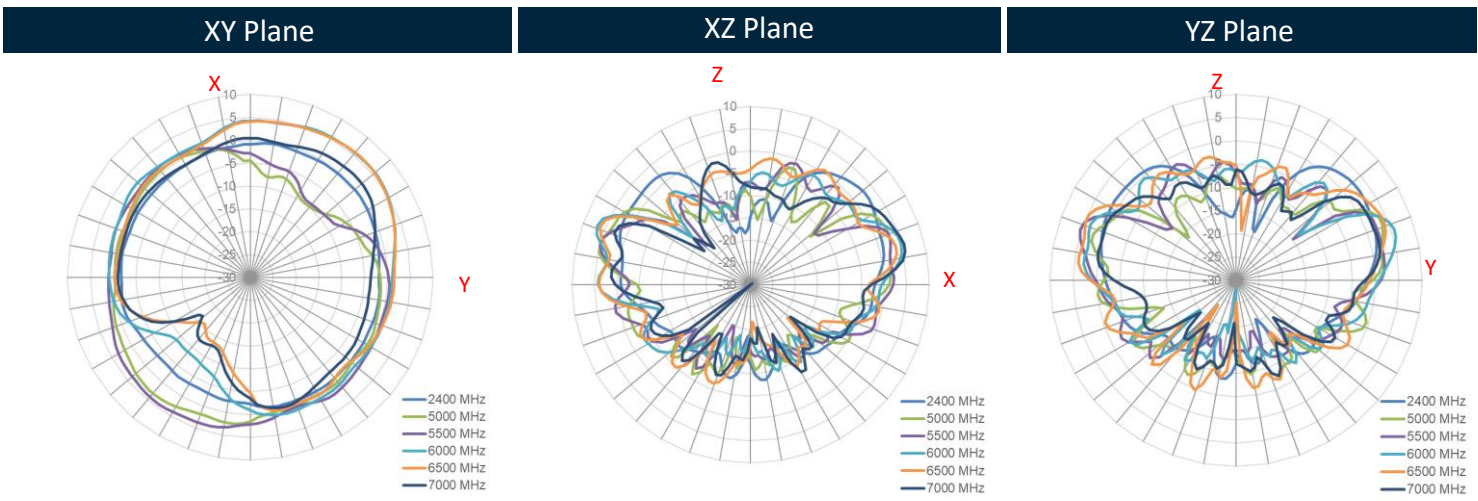

4.6 Bent 90° 30*30cm Center Ground Plane - 2D Radiation Patterns

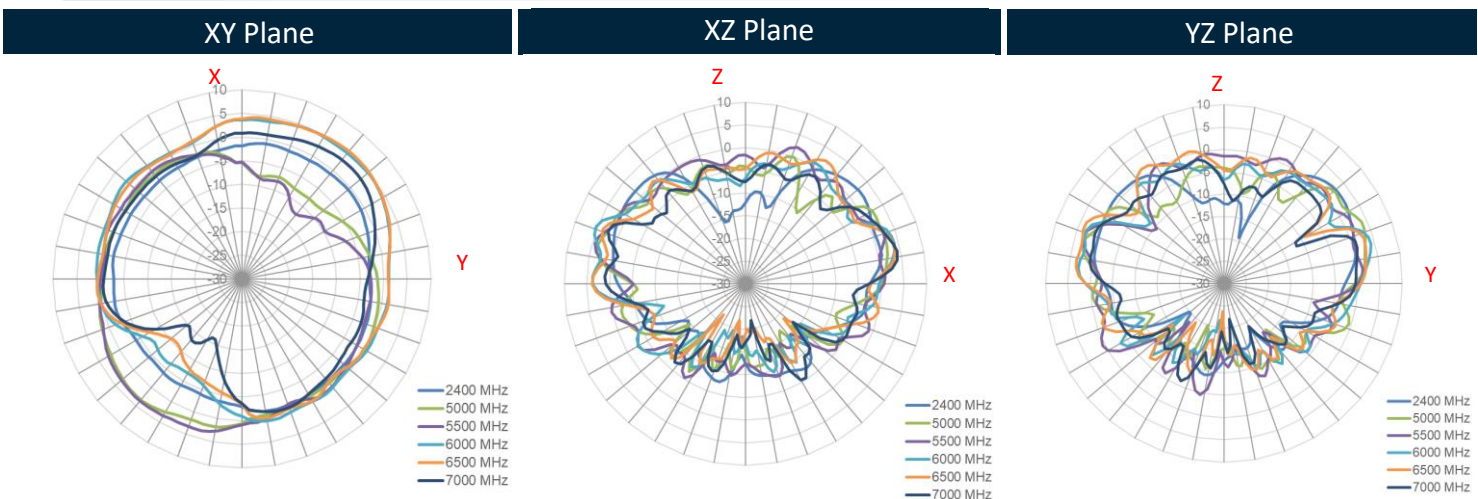

4.7 Straight 30*30cm Edge Ground Plane - 2D Radiation Patterns

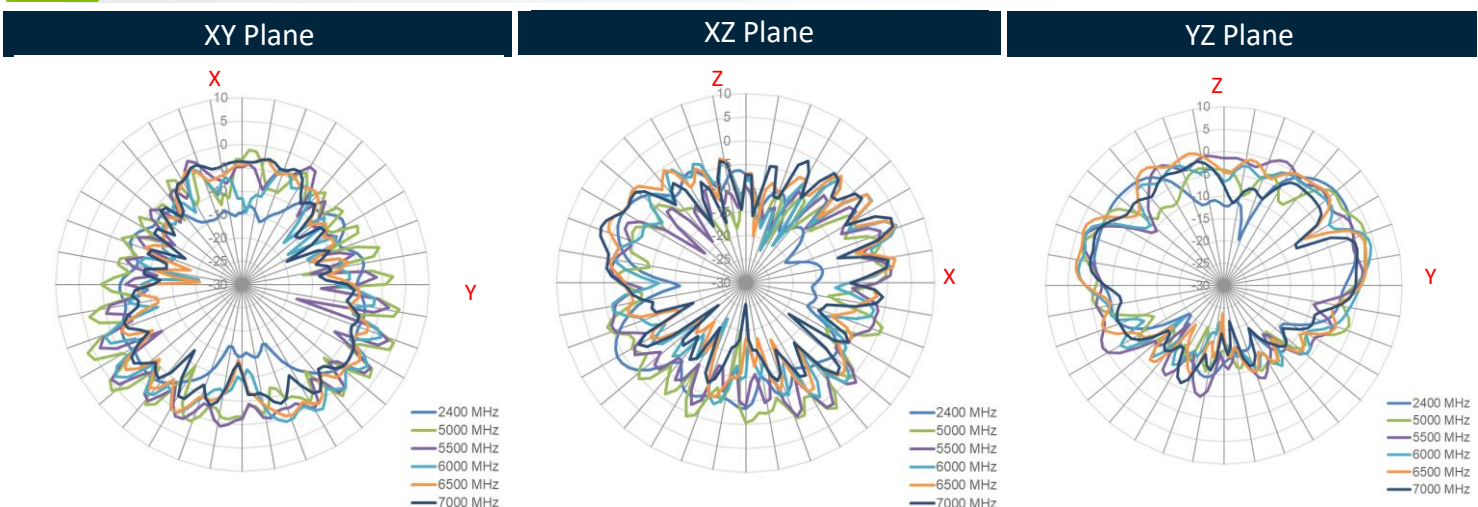

4.8 Bent 90° 30*30cm Edge Ground Plane - 2D Radiation Patterns

XY Plane

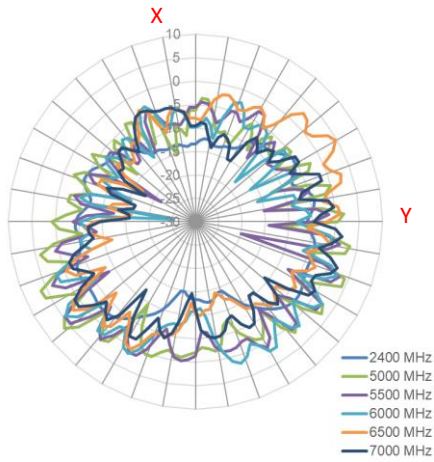

XZ Plane

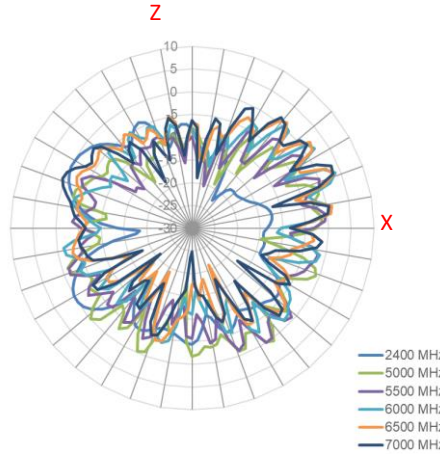

YZ Plane

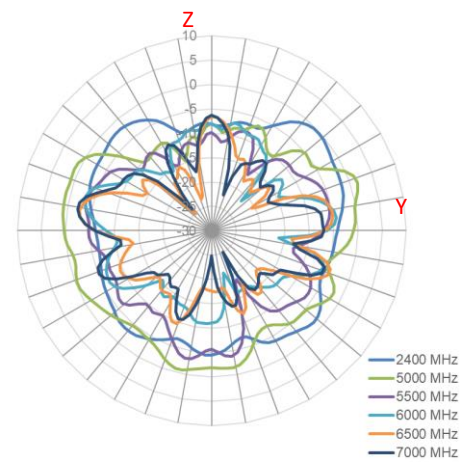

4.9 Straight 15*9cm Ground Plane - 2D Radiation Patterns

XY Plane

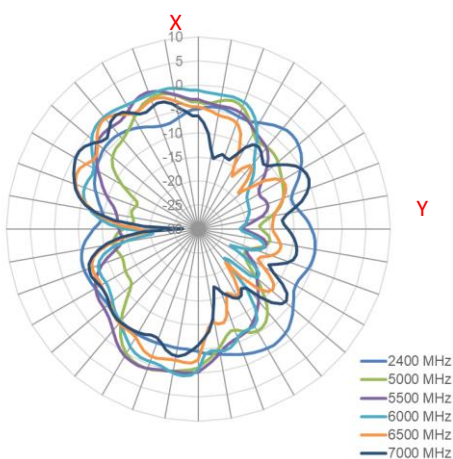

XZ Plane

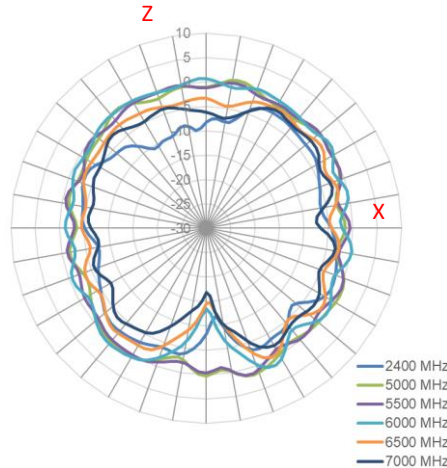

YZ Plane

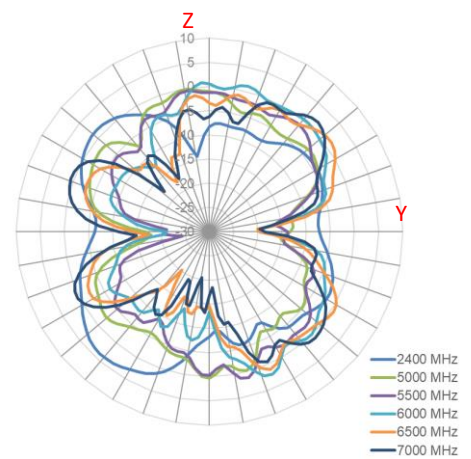

4.10 Bent 90° 15*9cm Ground Plane - 2D Radiation Patterns

XY Plane

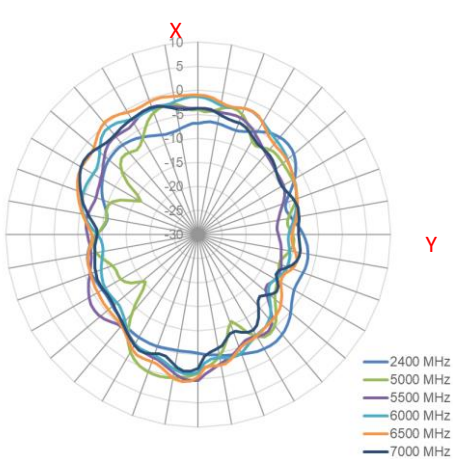

XZ Plane

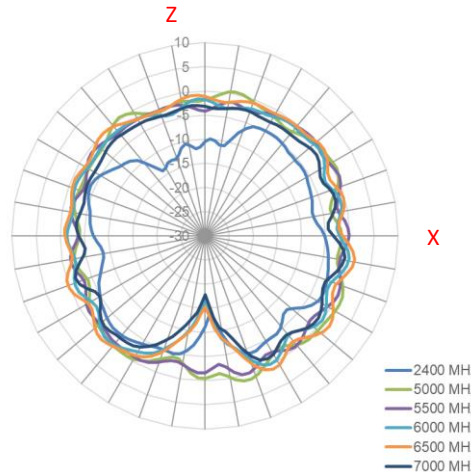

YZ Plane

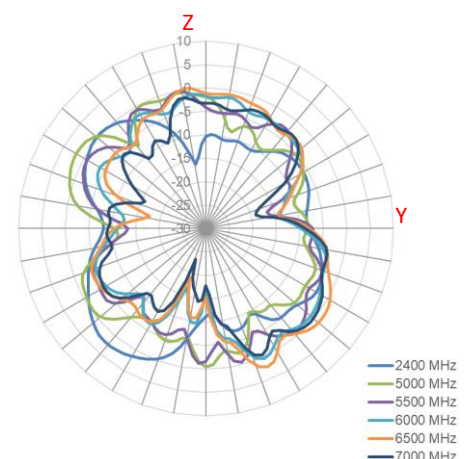

5. Mechanical Drawing (Units: mm)

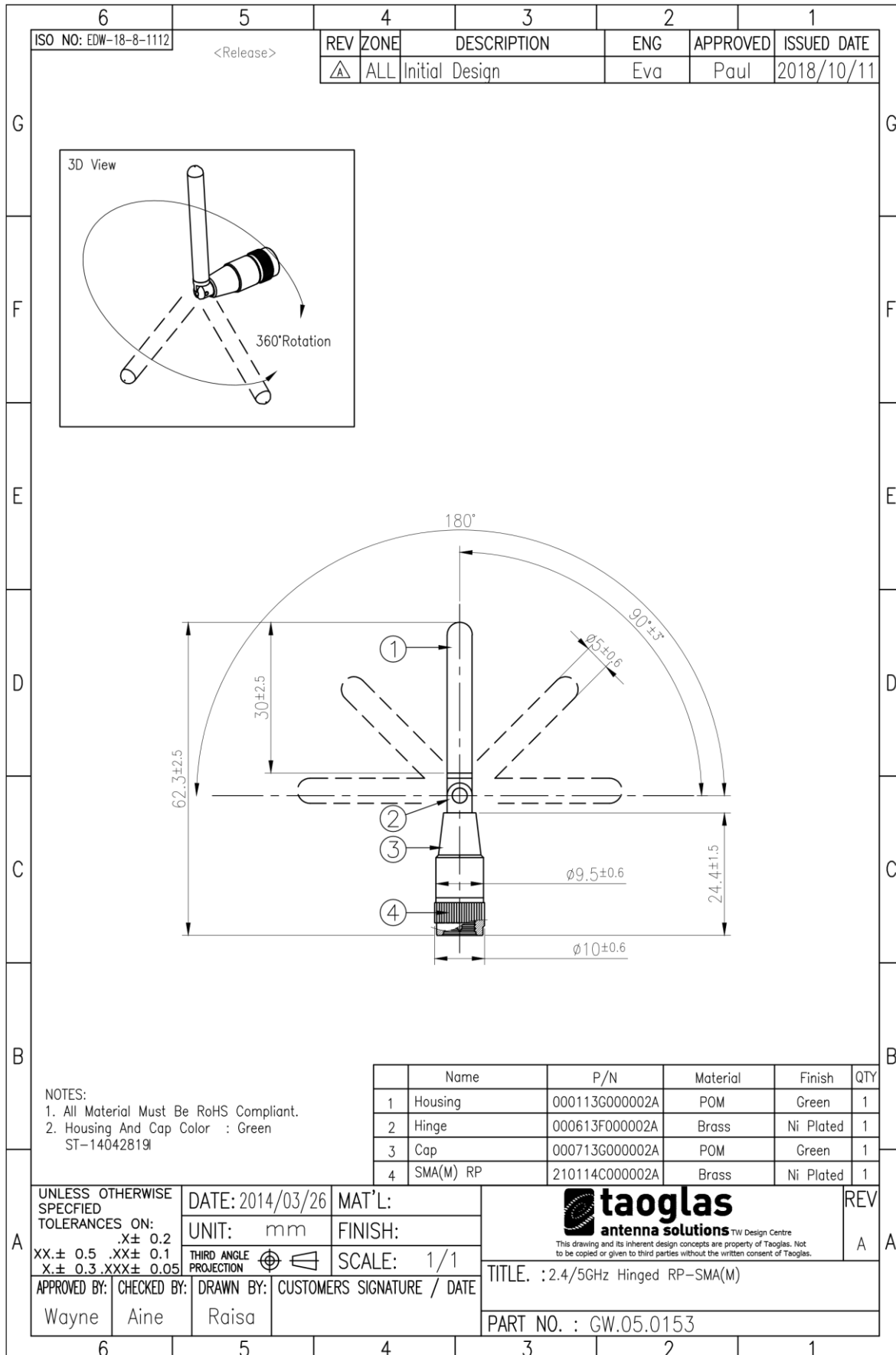

6. Installation

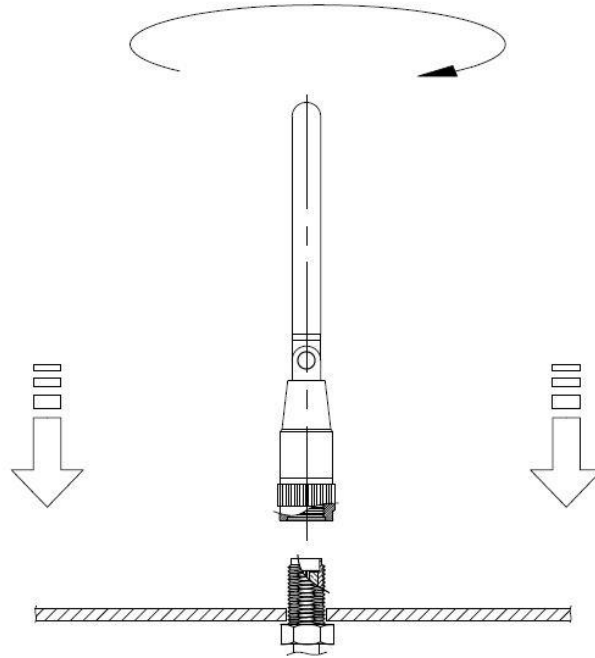

Recommended torque for mounting is 0.9 N·m
Maximum torque for mounting is 1.176 N·m

7. Packaging

1pc GW.05.0153 per PE Bag
 Bag Dimension: 74*42mm
 Weight: 8.5g



100pcs GW.05.0153 per Large PE Bag
 Bag Dimensions: 180*280mm
 Weight: 100g

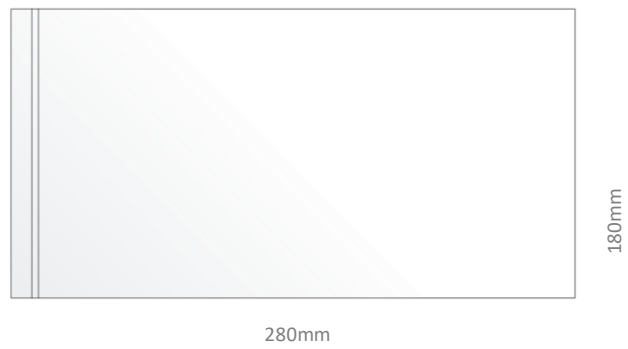

1500pcs GW.05.0153 per Carton
 Dimensions: 360*310*160mm
 Weight: 2.5Kg

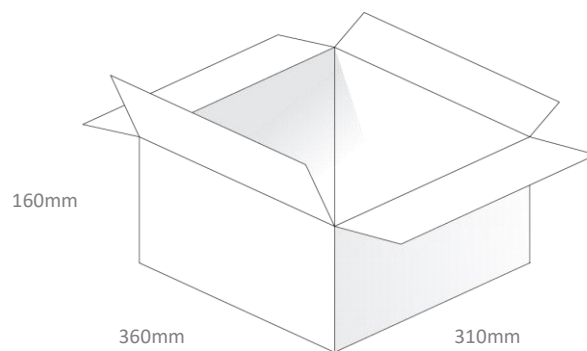

Changelog for the datasheet

SPE-14-8-105 – GW.05.0153

Revision: E (Current Version)

Date:	2020-06-16
Changes:	Updated to include Wi-Fi 6
Changes Made by:	Jack Conroy

Previous Revisions

Revision: D

Date:	2020-05-13
Changes:	Template and formatting updated
Changes Made by:	Jack Conroy

Revision: C

Date:	2015-08-24
Changes:	Amended Introduction
Changes Made by:	Aine Doyle

Revision: B

Date:	2015-02-05
Changes:	Added Gain note
Changes Made by:	Aine Doyle

Revision: A (Original First Release)

Date:	2014-09-26
Notes:	
Author:	Technical Writer



TAOGLAS®

www.taoglas.com

