

# Operating Instructions iTHERM CompactLine TM311

Compact thermometer with IO-Link

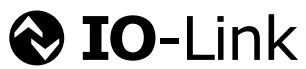



A0023555

## Table of contents

<b>1</b>	<b>About this document</b> .....	<b>4</b>	10.3	Overview of the diagnostic information .....	26
1.1	Document function .....	4	10.4	Diagnostic list .....	27
1.2	Symbols .....	4	10.5	Event logbook .....	27
1.3	Documentation .....	5			
1.4	Registered trademarks .....	6			
<b>2</b>	<b>Basic safety instructions</b> .....	<b>7</b>	<b>11</b>	<b>Maintenance</b> .....	<b>28</b>
2.1	Requirements for the personnel .....	7	11.1	Cleaning .....	28
2.2	Designated use .....	7	11.2	Services .....	28
2.3	Operational safety .....	7	<b>12</b>	<b>Repair</b> .....	<b>29</b>
2.4	Product safety .....	7	12.1	Spare parts .....	29
2.5	IT security .....	8	12.2	Return .....	29
			12.3	Disposal .....	29
<b>3</b>	<b>Product description</b> .....	<b>9</b>	<b>13</b>	<b>Accessories</b> .....	<b>30</b>
<b>4</b>	<b>Incoming acceptance and product identification</b> .....	<b>10</b>	13.1	Device-specific accessories .....	30
4.1	Incoming acceptance .....	10	13.2	Communication-specific accessories .....	32
4.2	Product identification .....	10	13.3	Service-specific accessories .....	34
4.3	Name and address of manufacturer .....	11	13.4	System components .....	34
4.4	Storage and transport .....	11	<b>14</b>	<b>Technical data</b> .....	<b>36</b>
<b>5</b>	<b>Mounting</b> .....	<b>12</b>	14.1	Input .....	36
5.1	Mounting requirements .....	12	14.2	Output .....	36
5.2	Mounting the thermometer .....	15	14.3	Power supply .....	37
5.3	Post-mounting check .....	16	14.4	Performance characteristics .....	38
<b>6</b>	<b>Electrical connection</b> .....	<b>17</b>	14.5	Environment .....	40
6.1	Connection conditions .....	17	14.6	Mechanical construction .....	41
6.2	Connecting the measuring device .....	17	14.7	Certificates and approvals .....	56
6.3	Ensuring the degree of protection .....	18	<b>15</b>	<b>Overview of the IO-Link operating menu</b> .....	<b>58</b>
6.4	Post-connection check .....	18	15.1	Description of device parameters .....	60
<b>7</b>	<b>Operation options</b> .....	<b>19</b>			
7.1	Protocol-specific data .....	19			
<b>8</b>	<b>System integration</b> .....	<b>20</b>			
8.1	Identification .....	20			
8.2	Process data .....	20			
8.3	Reading and writing device data .....	21			
<b>9</b>	<b>Commissioning</b> .....	<b>24</b>			
9.1	Post-installation check .....	24			
9.2	Configuring the measuring device .....	24			
<b>10</b>	<b>Diagnostics and troubleshooting</b> ...	<b>25</b>			
10.1	General troubleshooting .....	25			
10.2	Diagnostic information via communication interface .....	25			

# 1 About this document

## 1.1 Document function

These Operating Instructions contain all the information required in the various life cycle phases of the device: from product identification, incoming acceptance and storage, to installation, connection, operation and commissioning, through to troubleshooting, maintenance and disposal.

## 1.2 Symbols

### 1.2.1 Safety symbols

#### **DANGER**

This symbol alerts you to a dangerous situation. Failure to avoid this situation will result in serious or fatal injury.

#### **WARNING**

This symbol alerts you to a dangerous situation. Failure to avoid this situation can result in serious or fatal injury.





#### **CAUTION**

This symbol alerts you to a dangerous situation. Failure to avoid this situation can result in minor or medium injury.



#### **NOTICE**









This symbol contains information on procedures and other facts which do not result in personal injury.

### 1.2.2 Electrical symbols



Symbol	Meaning
	Direct current
	Alternating current
	Direct current and alternating current
	<b>Ground connection</b> A grounded terminal which, as far as the operator is concerned, is grounded via a grounding system.
	<b>Potential equalization connection (PE: protective earth)</b> Ground terminals that must be connected to ground prior to establishing any other connections.  The ground terminals are located on the interior and exterior of the device: <ul style="list-style-type: none"> <li>▪ Interior ground terminal: potential equalization is connected to the supply network.</li> <li>▪ Exterior ground terminal: device is connected to the plant grounding system.</li> </ul>

### 1.2.3 Symbols for certain types of information

Symbol	Meaning
	<b>Permitted</b> Procedures, processes or actions that are permitted.
	<b>Preferred</b> Procedures, processes or actions that are preferred.
	<b>Forbidden</b> Procedures, processes or actions that are forbidden.

Symbol	Meaning
	<b>Tip</b> Indicates additional information.
	Reference to documentation
	Reference to page
	Reference to graphic
	Notice or individual step to be observed
	Series of steps
	Result of a step
	Help in the event of a problem
	Visual inspection

### 1.2.4 Symbols in graphics

Symbol	Meaning	Symbol	Meaning
1, 2, 3,...	Item numbers		Series of steps
A, B, C, ...	Views	A-A, B-B, C-C, ...	Sections
	Hazardous area		Safe area (non-hazardous area)

### 1.2.5 Tool symbols

Symbol	Meaning
 <small>A0011222</small>	Open-ended wrench

## 1.3 Documentation

 For an overview of the scope of the associated Technical Documentation, refer to the following:

- *W@M Device Viewer* ([www.endress.com/deviceviewer](http://www.endress.com/deviceviewer)): Enter the serial number from the nameplate
- *Endress+Hauser Operations App*: Enter the serial number from the nameplate or scan the matrix code on the nameplate

### 1.3.1 Document function

Document type	Purpose and content of the document
Technical Information (TI)	<b>Planning aid for your device</b> The document contains all the technical data on the device and provides an overview of the accessories and other products that can be ordered for the device.
Brief Operating Instructions (KA)	<b>Guide that takes you quickly to the 1st measured value</b> The Brief Operating Instructions contain all the essential information from incoming acceptance to initial commissioning.

Document type	Purpose and content of the document
Operating Instructions (BA)	<b>Your reference guide</b> These Operating Instructions contain all the information that is required in the various life cycle phases of the device: from product identification, incoming acceptance and storage, to mounting, connection, operation and commissioning, through to troubleshooting, maintenance and disposal.
Description of Device Parameters (GP)	<b>Reference for your parameters</b> The document provides a detailed explanation of each individual parameter. The description is aimed at those who work with the device over the entire life cycle and perform specific configurations.
Safety Instructions (XA)	Depending on the approval, safety instructions for electrical equipment in hazardous areas are also supplied with the device. They are an integral part of the Operating Instructions.  The nameplate indicates which Safety Instructions (XA) apply to the device in question.
Supplementary device-dependent documentation	Additional documents are supplied depending on the device version ordered: Always comply strictly with the instructions in the supplementary documentation. The supplementary documentation is an integral part of the device documentation.

## 1.4 Registered trademarks

### IO-Link®

Is a registered trademark. It may only be used in conjunction with products and services by members of the IO-Link Community or by non-members who hold an appropriate license. For more detailed information on the use of IO-Link, please refer to the rules of the IO-Link Community at: [www.io.link.com](http://www.io.link.com).

## 2 Basic safety instructions

### 2.1 Requirements for the personnel

The personnel for installation, commissioning, diagnostics and maintenance must fulfill the following requirements:

- ▶ Trained, qualified specialists must have a relevant qualification for this specific function and task.
- ▶ Are authorized by the plant owner/operator.
- ▶ Are familiar with federal/national regulations.
- ▶ Before starting work, read and understand the instructions in the manual and supplementary documentation as well as the certificates (depending on the application).
- ▶ Follow instructions and comply with basic conditions.

The operating personnel must fulfill the following requirements:

- ▶ Are instructed and authorized according to the requirements of the task by the facility's owner-operator.
- ▶ Follow the instructions in this manual.

### 2.2 Designated use

- The device is a compact thermometer for industrial temperature measurement.
- The manufacturer is not liable for damage caused by improper or non-designated use.

### 2.3 Operational safety

Risk of injury!

- ▶ Operate the device only if it is in proper technical condition, free from errors and faults.
- ▶ The operator is responsible for the interference-free operation of the device.

#### Modifications to the device

Unauthorized modifications to the device are not permitted and can lead to unforeseeable dangers!

- ▶ If modifications are nevertheless required, consult with the manufacturer.

#### Repair

To ensure continued operational safety and reliability:

- ▶ Carry out repairs on the device only if they are expressly permitted.
- ▶ Observe federal/national regulations pertaining to the repair of an electrical device.
- ▶ Use only original spare parts and accessories.

### 2.4 Product safety

This measuring device is designed in accordance with good engineering practice to meet state-of-the-art safety requirements, has been tested, and left the factory in a condition in which it is safe to operate.

It meets general safety standards and legal requirements. It also complies with the EC directives listed in the device-specific EC Declaration of Conformity. Endress+Hauser confirms this by affixing the CE mark to the device.

Furthermore, the device meets the legal requirements of the applicable UK regulations (Statutory Instruments). These are listed in the UKCA Declaration of Conformity along with the designated standards.

By selecting the order option for UKCA marking, Endress+Hauser confirms a successful evaluation and testing of the device by affixing the UKCA mark.

Contact address Endress+Hauser UK:

Endress+Hauser Ltd.  
Floats Road  
Manchester M23 9NF  
United Kingdom  
[www.uk.endress.com](http://www.uk.endress.com)

## 2.5 IT security

Our warranty is valid only if the device is installed and used as described in the Operating Instructions. The device is equipped with security mechanisms to protect it against any inadvertent changes to the settings.

IT security measures, which provide additional protection for the device and associated data transfer, must be implemented by the operators themselves in line with their security standards.

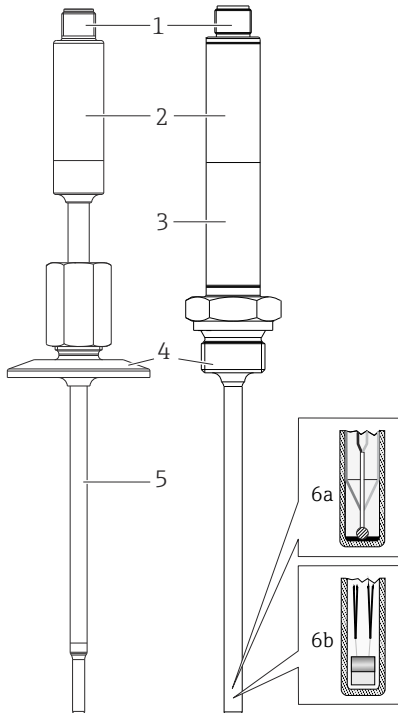

### 3 Product description

Design	Options
 <p>1: Electrical connection, output signal 2: Transmitter housing</p> <p>3: Extension neck</p> <p>4: Process connection → 49</p> <p>5: Thermowell</p> <p>6: Insert with: 6a: iTHERM TipSens 6b: Pt100 (TF), basic</p> <p>A0039771</p>	<p><b>i</b> <b>Your benefits:</b></p> <ul style="list-style-type: none"> <li>▪ M12, 4-pin connector, reduced cost and effort, incorrect wiring is prevented</li> <li>▪ Optimum protection, IP69 as standard</li> <li>▪ Compact, integrated transmitter (IO-Link and 4 to 20 mA)</li> </ul>
	<p>Optionally available if process temperature is too high for the electronics</p>
	<p>Over 50 different versions for industrial, hygienic and aseptic applications.</p>
	<ul style="list-style-type: none"> <li>▪ Versions with and without thermowell (insert in direct contact with process)</li> <li>▪ Thermowell diameter 6 mm and optimized T-pieces and elbow pieces</li> </ul>
	<p><b>i</b> <b>Your benefits:</b></p> <ul style="list-style-type: none"> <li>▪ <b>iTHERM TipSens</b> - insert with shortest response times: <ul style="list-style-type: none"> <li>▪ Insert: <math>\varnothing 3</math> mm (<math>\frac{1}{8}</math> in) or <math>\varnothing 6</math> mm (<math>\frac{1}{4}</math> in)</li> <li>▪ Fast, highly accurate measurements, delivering maximum process safety and control</li> <li>▪ Quality and cost optimization</li> <li>▪ Minimization of necessary immersion length: better product protection thanks to improved process flow</li> </ul> </li> <li>▪ <b>Pt100 (TF), basic</b></li> <li>▪ Excellent cost-performance ratio</li> </ul>

## 4 Incoming acceptance and product identification

### 4.1 Incoming acceptance

Proceed as follows on receipt of the device:

1. Check whether the packaging is intact.
2. If damage is discovered:  
Report all damage immediately to the manufacturer.
3. Do not install damaged components, as the manufacturer cannot otherwise guarantee the material resistance or compliance with the original safety requirements, and can also not be held responsible for the consequences that may result.
4. Compare the scope of delivery against the contents of your order.
5. Remove all the packaging material used for transportation.
6. Do the data on the nameplate match the ordering information on the delivery note?
7. Are the technical documentation and all other necessary documents provided, e.g. certificates?



If one of the conditions is not satisfied, contact your Sales Center.

### 4.2 Product identification

The device can be identified in the following ways:

- Nameplate specifications
- Enter the serial number from the nameplate in the *W@M Device Viewer* [www.endress.com/deviceviewer](http://www.endress.com/deviceviewer): All data relating to the device and an overview of the Technical Documentation supplied with the device are displayed.

#### 4.2.1 Nameplate

**The correct device?**

1. Check the data on the nameplate of the device.
2. Compare against the requirements of the measuring point.

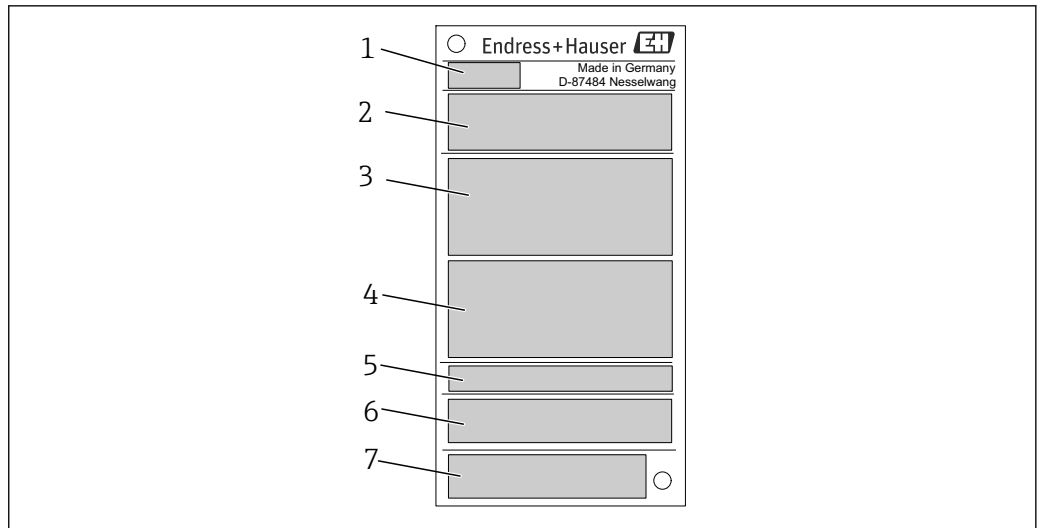

1 Sample graphic

- 1 Product root, device designation
- 2 Order code, serial number
- 3 Tag name
- 4 Technical values: supply voltage, current consumption, ambient temperature
- 5 Degree of protection
- 6 Pin assignment
- 7 Approvals with symbols: CE mark, EAC

### 4.2.2 Scope of delivery

The scope of delivery comprises:

- Compact thermometer
- Printed copy of the Brief Operating Instructions
- Accessories ordered

### 4.3 Name and address of manufacturer

<b>Name of manufacturer:</b>	Endress+Hauser Wetzler GmbH + Co. KG
<b>Address of manufacturer:</b>	Obere Wank 1, D-87484 Nesselwang or <a href="http://www.endress.com">www.endress.com</a>
<b>Address of manufacturing plant:</b>	See nameplate

### 4.4 Storage and transport

For dimensions, see "Technical data" → 41

Storage temperature: -40 to +85 °C (-40 to +185 °F)

- i** Avoid the following environmental influences during storage:
  - direct sunlight
  - proximity to hot objects
  - mechanical vibration
  - aggressive media

## 5 Mounting

### 5.1 Mounting requirements

**i** Information on the conditions that must be present at the mounting location to ensure correct use (e.g. ambient temperature, degree of protection, climate class, etc.) and information on the device dimensions →  36

#### 5.1.1 Orientation

No restrictions. However, self-draining in the process must be guaranteed. If there is an opening to detect leaks at the process connection, this opening must be at the lowest possible point.

#### 5.1.2 Installation instructions

The immersion length of the compact thermometer can considerably influence the accuracy. If the immersion length is too short, measurement errors can occur as a result of heat conduction via the process connection and the vessel wall. Therefore, if installing in a pipe, the immersion length should ideally correspond to half of the pipe diameter.

Installation possibilities: pipes, tanks or other plant components.

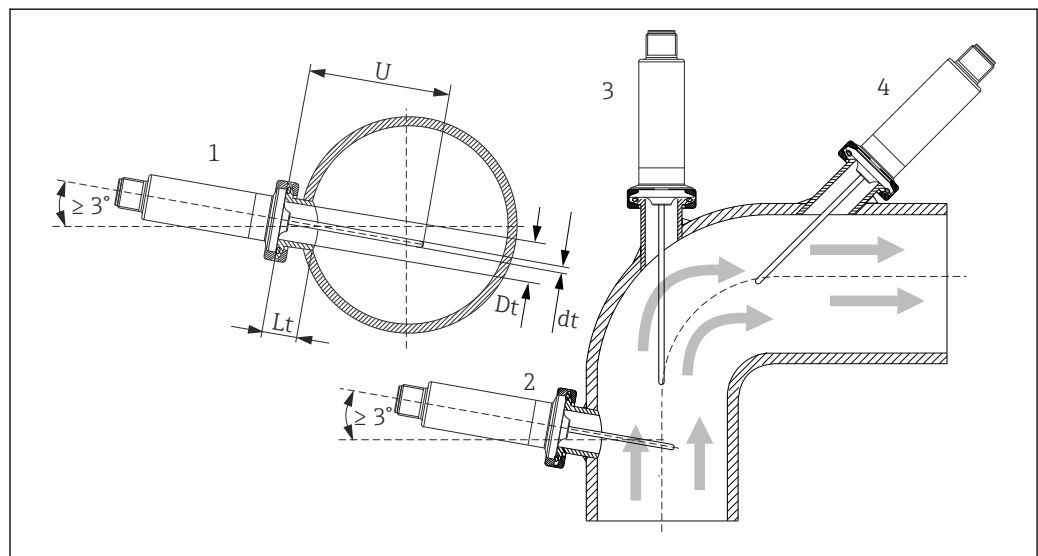

A0040370

 2 Installation examples

- 1, 2 Perpendicular to flow direction, installed at a minimum angle of  $3^\circ$ , to ensure self-draining
- 3 On elbows
- 4 Inclined installation in pipes with a small nominal diameter
- U Immersion length

**i** The requirements of the EHEDG and the 3-A Sanitary Standard must be adhered to.

Installation instruction EHEDG/cleanability:  $L_t \leq (D_t - d_t)$

Installation instruction 3-A/cleanability:  $L_t \leq 2(D_t - d_t)$

Pay attention to the exact position of the sensor element in the thermometer tip.

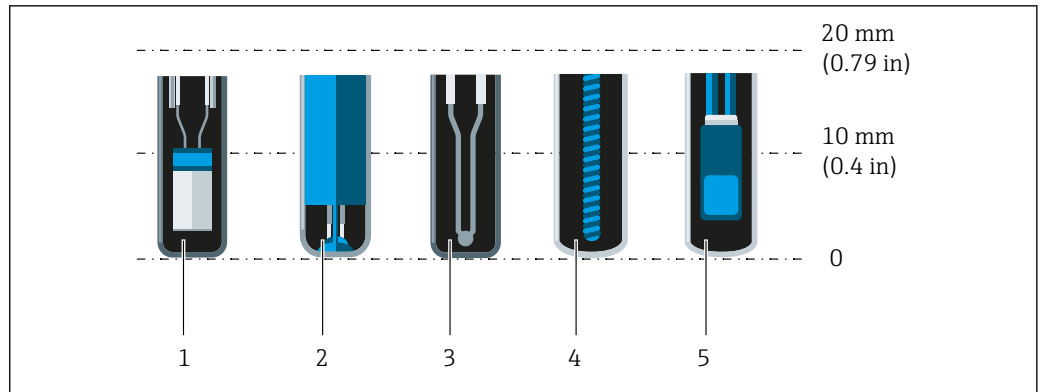

A0041814

- 1 StrongSens or TrustSens at 5 to 7 mm (0.2 to 0.28 in)
- 2 QuickSens at 0.5 to 1.5 mm (0.02 to 0.06 in)
- 3 Thermocouple (not grounded) at 3 to 5 mm (0.12 to 0.2 in)
- 4 Wire wound sensor at 5 to 20 mm (0.2 to 0.79 in)
- 5 Standard thin-film sensor at 5 to 10 mm (0.2 to 0.39 in)

To keep the influence of heat dissipation to a minimum and to achieve the best possible measurement results, 20 to 25 mm (0.79 to 0.98 in) should be in contact with the medium in addition to the actual sensor element.

This results in the following recommended minimum immersion lengths

- TrustSens or StrongSens 30 mm (1.18 in)
- QuickSens 25 mm (0.98 in)
- Wire wound sensor 45 mm (1.77 in)
- Standard thin-film sensor 35 mm (1.38 in)

It is particularly important to take this into consideration for T-pieces, as the immersion length is very short on account of their design, and the measured error is higher as a result. It is therefore recommended to use elbow pieces with QuickSens sensors.

- i** In the case of pipes with a small nominal diameter, it is advisable for the tip of the thermometer to project well into the process so that it extends past the pipe axis. Installation at an angle (4) could be another solution. When determining the immersion or insertion length, all the parameters of the thermometer and of the medium to be measured must be taken into account (e.g. Flow velocity, process pressure).

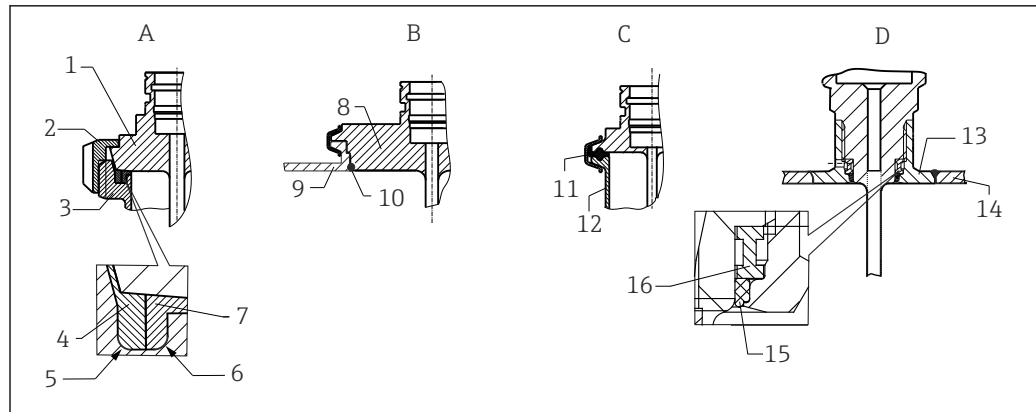

A0040345

**3** Detailed installation instructions for hygiene-compliant installation

**A** Milk pipe connection according to DIN 11851, only in conjunction with EHEDG-certified, self-centering sealing ring

1 Sensor with milk pipe connection

2 Groove slip-on nut

3 Counterpart connection

4 Centering ring

5 RO.4

6 RO.4

7 Sealing ring

**B** Varivent® process connection for VARINLINE® housing

8 Sensor with Varivent connection

9 Counterpart connection

10 O-ring

**C** Clamp according to ISO 2852

11 Molded seal

12 Counterpart connection

**D** Process connection Liquiphant-M G1", horizontal installation

13 Weld-in adapter

14 Vessel wall

15 O-ring

16 Thrust collar

**i** The counterparts for the process connections and the seals or sealing rings are not supplied with the thermometer. Liquiphant M weld-in adapters with associated seal kits are available as accessories. → **30**

#### NOTICE

**The following actions must be taken if a sealing ring (O-ring) or seal fails:**

- ▶ The thermometer must be removed.
- ▶ The thread and the O-ring joint/sealing surface must be cleaned.
- ▶ The sealing ring or seal must be replaced.
- ▶ CIP must be performed after installation.

In the case of weld-in connections, exercise the necessary degree of care when performing the welding work on the process side:

1. Use suitable welding material.
2. Flush-weld or weld with welding radius  $\geq 3.2$  mm (0.13 in).
3. Avoid crevices, folds or gaps.
4. Ensure the surface is honed and mechanically polished,  $R_a \leq 0.76$   $\mu\text{m}$  (30  $\mu\text{in}$ ).

Pay attention to the following when installing the thermometer to ensure that the cleanability is not affected:

1. The installed sensor is suitable for CIP (cleaning in place). Cleaning is performed together with the pipe or tank. In the case of internal tank fixtures using process connection nozzles, it is important to ensure that the cleaning assembly sprays this area directly so that it is cleaned properly.
2. The Varivent® connections enable flush-mounted installation.

### 5.1.3 General installation instructions

**i** The device generates diagnostic message **S825** if a device temperature of 100 °C is reached due to unfavorable conditions (high process temperature, high ambient temperature, electronics close to the process). The device generates diagnostic message **F001** or **Failure current** if the device temperature is 125 °C or higher.

#### Ambient temperature range

$T_a$	-40 to +85 °C (-40 to +185 °F)
-------	--------------------------------

#### Process temperature range

The thermometer electronics must be protected against temperatures over 85 °C (185 °F) by an extension neck of the appropriate length.

#### Device version without electronics (order code 020, option A)

Pt100 TF, basic, without extension neck	-50 to +150 °C (-58 to +302 °F)
Pt100 TF, basic, with extension neck	-50 to +150 °C (-58 to +302 °F)
iTHERM TipSens, without extension neck	-50 to +200 °C (-58 to +392 °F)
iTHERM TipSens, with extension neck	-50 to +200 °C (-58 to +392 °F)

#### Device version with electronics (order code 020, option B, C)

Pt100 TF, basic, without extension neck	-50 to +150 °C (-58 to +302 °F)
Pt100 TF, basic, with extension neck	-50 to +150 °C (-58 to +302 °F)
iTHERM TipSens, without extension neck	-50 to +150 °C (-58 to +302 °F)
iTHERM TipSens, with extension neck	-50 to +200 °C (-58 to +392 °F)

## 5.2 Mounting the thermometer

Proceed as follows to mount the device:

1. The permitted loading capacity of the process connections can be found in the relevant standards.
2. The process connection and compression fitting must comply with the maximum specified process pressure.

3. Make sure that the device is installed and secured before applying the process pressure.
4. Adjust the loading capacity of the thermowell to the process conditions.
5. It may be necessary to calculate the static and dynamic loading capacity.

**i** It is possible to verify the mechanical loading capacity as a function of the installation and process conditions using the online TW Sizing Module for thermowells in the Endress+Hauser Applicator software →  34.

### 5.2.1 Cylindrical threads

#### NOTICE

#### Seals must be used for cylindrical threads.

In the case of combined thermometer and thermowell assemblies, these seals are already installed (depending on the version ordered).

- ▶ The system operator is required to verify the suitability of this seal with regard to the operating conditions.

Threaded version	Tightening torque [Nm]
Compact thermometer with T-piece or elbow piece thermowell	5
Process connection, metal sealing system	10
Compression fitting, spherical, PEEK seal	10
Compression fitting, spherical, 316L seal	25
Compression fitting, cylindrical, Elastosil seal	5

1. Replace with a suitable seal if necessary.
2. Replace the seals following disassembly.
3. As all threads must be firmly tightened, using the appropriate torques.

### 5.2.2 Tapered threads

- ▶ The operator must verify if additional sealing by means of PTFE tape, hemp or an additional welded seam, for example, is necessary in the case of NPT threads or other tapered threads.

## 5.3 Post-mounting check

<input type="checkbox"/>	Is the device undamaged (visual inspection)?
<input type="checkbox"/>	Is the device correctly secured?
<input type="checkbox"/>	Does the device correspond to the specifications at the measuring point, e.g. ambient temperature, measuring range etc.? →  36



## 6 Electrical connection

### 6.1 Connection conditions

**i** If the 3-A Standard is required, electrical connecting cables must be smooth, corrosion-resistant and easy to clean.

### 6.2 Connecting the measuring device

#### NOTICE

##### Damage to the device!

- ▶ Do not overtighten the M12 plug, as this could damage the device. Maximum torque: 0.4 Nm (M12 knurl)

#### IO-Link operating mode

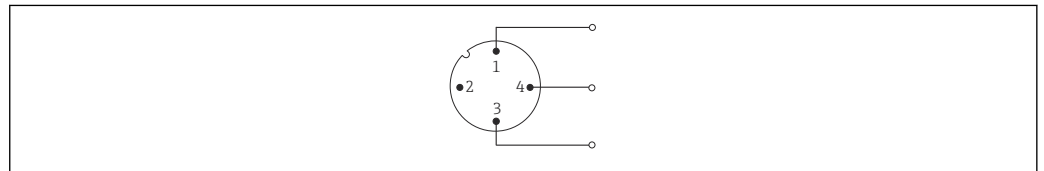

A0040342

**4** Pin assignment, device plug

- 1 Pin 1 - power supply 15 to 30 V<sub>DC</sub>
- 2 Pin 2 - not used
- 3 Pin 3 - power supply 0 V<sub>DC</sub>
- 4 Pin 4 - C/Q (IO-Link or switch output)

#### 4 to 20 mA operating mode

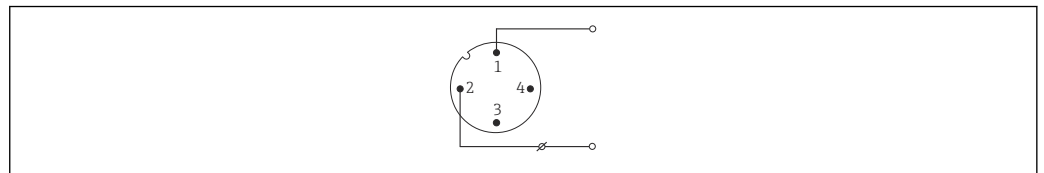

A0040343

**5** Pin assignment, device plug

- 1 Pin 1 - power supply 10 to 30 V<sub>DC</sub>
- 2 Pin 2 - power supply 0 V<sub>DC</sub>
- 3 Pin 3 - not used
- 4 Pin 4 - not used

#### Without electronics

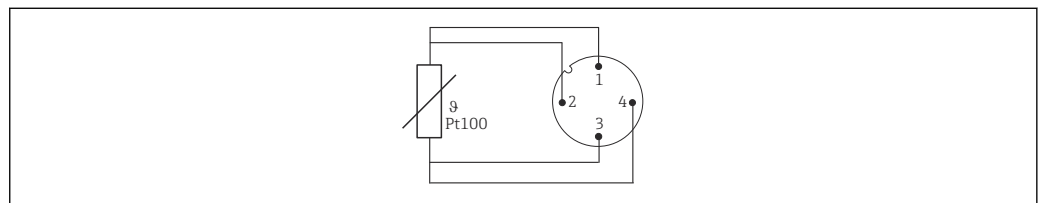

A0040344

**6** Pin assignment of device plug: Pt100, 4-wire connection

### 6.3 Ensuring the degree of protection

The indicated degree of protection is ensured if the M12x1 cable connector meets the required degree of tightness. For compliance with IP69 protection, suitable device connecting cables with straight or elbowed connectors are available →  34.

### 6.4 Post-connection check

<input type="checkbox"/>	Are the device and cable undamaged (visual check)?
<input type="checkbox"/>	Do the mounted cables have suitable strain relief?
<input type="checkbox"/>	Does the supply voltage match the information on the nameplate?

## 7 Operation options

### 7.1 Protocol-specific data

#### 7.1.1 IO-Link information

IO-Link is a point-to-point connection for communication between the device and an IO-Link master. The IO-Link communication interface enables direct access to the process and diagnostic data. It also provides the option of configuring the device while in operation.

*The device supports the following features:*

IO-Link specification	Version 1.1
IO-Link Smart Sensor Profile 2nd Edition	Supported: <ul style="list-style-type: none"> <li>▪ Identification</li> <li>▪ Diagnosis</li> <li>▪ Digital Measuring Sensor (as per SSP type 3.1)</li> </ul>
SIO mode	Yes
Speed	COM2; 38.4 kBaud
Minimum cycle time	10 ms
Process data width	4 byte
IO-Link data storage	Yes
Block configuration according to V1.1	Yes
Device operational	The device is operational 0.5 s after the supply voltage is applied (first valid measured value after 2 s)

#### 7.1.2 Device description

In order to integrate field devices into a digital communication system, the IO-Link system needs a description of the device parameters, such as output data, input data, data format, data volume and supported transfer rate.

This data is available in the device description (IODD<sup>1)</sup>), which is provided to the IO-Link master via generic modules when the communication system is commissioned.

-  The IODD can be downloaded as follows:
- Endress+Hauser: [www.endress.com](http://www.endress.com)
  - IODDfinder: <http://ioddfinder.io-link.com>

1) IO Device Description

## 8 System integration

### 8.1 Identification

Device ID	0x030100 (196864)
Vendor ID	0x0011 (17)

### 8.2 Process data

When the measuring device is operated in digital mode, the state of the switch output and the temperature value are transmitted in the form of process data via IO-Link. The signal is initially transmitted in the SIO-Mode (Standard IO-Mode). Digital IO-Link communication starts as soon as the IO-Link master sends the "Wake Up" command.

- In the SIO mode, the switch output is switched at pin 4 of the M12 plug. In the IO-Link communication mode, this pin is reserved exclusively for communication.
- The measuring device's process data are transmitted cyclically in 32-bit chunks.

Byte 1								Byte 2							
31	30	29	28	27	26	25	24	23	22	21	20	19	18	17	16
sint16															
Temperature (with one decimal place)															

Byte 3								Byte 4							
15	14	13	12	11	10	9	8	7	6	5	4	3	2	1	0
sint8								Enum4				Bool			
Scale (-1)								Measured value status				Switch state			

#### Explanation

Process value	Values	Meaning
Temperature	-32 000 to 32 000	Temperature value with one decimal place Example: a transmitted value of 123 corresponds to a measured temperature value of 12.3 °C
	32764 = No measurement data	Process value if no valid measured value is available
	- 32760 = Out of range (-)	Process value if the measured value is below the lower limit value
	32760 = Out of range (+)	Process value if the measured value is above the upper limit value
Scale	-1	The transmitted measured value must be multiplied by 10exp (Scale)
Measured value status [bit 4 - 3]	0 = Bad	Measured value cannot be used
	1 = Uncertain	Measured value can only be used to a limited extent, e.g.: device temperature is outside the permitted range (S825)
	2 = Manual/Fixed	Measured value can only be used to a limited extent, e.g.: simulation of the measured variable is active (C485)
	3 = Good	Measured value is good

Process value	Values	Meaning
Measured value status [bit 2 - 1]	0 = Not limited	Measured value without limit value violation
	1 = Low limited	Limit value violation at lower end
	2 = High limited	Limit value violation at upper end
	3 = Constant	Measured value is set to a constant value, e.g.: simulation active
Switch output [bit 0]	0 = Off	Switch output opened
	1 = On	Switch output closed

## 8.3 Reading and writing device data

Device data are always exchanged acyclically and at the request of the IO-Link master via the ISDU communication channel. The IO-Link master can read the following parameter values or device conditions:

### 8.3.1 Specific device data

 The default values apply to parameters which are not ordered with customer-specific settings.

Identifier	Index (dec)	Index (hex)	Size (byte)	Data type	Access	Default value	Value range	Data storage
Application specific tag	24	0x0018	32	String	r/w	-	-	Yes
Order code	1054	0x041E	20	String	r/-	-	-	-
Extended order code	259	0x0103	60	String	r/-	-	-	-
Device type	256	0x0100	2	UInteger16	r/-	0x93FF	-	-
unit	5121	0x1401	1	UInteger8	r/w	32	32 = °C 33 = °F 35 = K	Yes
Damping	7271	0x1C67	1	UInteger8	r/w	0 s	0 to 120 s	Yes
Sensor offset	3082	0x0C0A	4	Float	r/w	0 °C (32 °F)	-10 to +10 °C (-18 to +18 °F)	Yes
Operating mode switch	2050	0x0802	2	UInteger16	r/w	Hysteresis normally open (0x0C9C)	Window normally open (0x0CFF) Window normally closed (0x0C96) Hysteresis normally open (0x0C9C) Hysteresis normally closed (0x0C99) Off (0x80EC)	Yes
Switch point value	2051	0x0803	4	Float	r/w	100 °C (212 °F)	-1E+20 to 1E+20	Yes
Switchback point value	2052	0x0804	4	Float	r/w	90 °C (194 °F)	-1E+20 to 1E+20	Yes
Switch delay	2053	0x0805	1	UInteger8	r/w	0 s	0 to 99 s	Yes
Switchback delay	2054	0x0806	1	UInteger8	r/w	0 s	0 to 99 s	Yes
4 mA value	8218	0x201A	4	Float	r/w	0 °C (32 °F)	-50 000 to 50 000 °C	Yes
20 mA value	8219	0x201B	4	Float	r/w	150 °C	-50 000 to 50 000 °C	Yes
Current trimming 4mA	8213	0x2015	4	Float	r/w	4.00 mA	3.85 to 4.15 mA	Yes
Current trimming 20mA	8212	0x2014	4	Float	r/w	20.00 mA	19.85 to 20.15 mA	Yes
Failure mode	8234	0x202A	1	UInteger8	r/w	0 = Low alarm	0 = Low alarm 2 = High alarm	Yes
Failure current	8232	0x2028	4	Float	r/w	22.5 mA	21.5 to 23 mA	Yes

Identifier	Index (dec)	Index (hex)	Size (byte)	Data type	Access	Default value	Value range	Data storage
Operating time	6148	0x1804	4	UInteger32	r/-	-	-	Yes
Alarm delay	6147	0x1803	1	UInteger8	r/w	2 s	1 to 5 s	Yes
Device status	36	0x0024	1	UInteger8	r/-	-	0 = Device is OK 1 = Maintenance required 2 = Out of specification 3 = Functional check 4 = Failure	-
Detailed device status	37	0x0025	36	OctetString	r/-	-	In accordance with IO-Link specification	-
Actual diagnostic 1	6184	0x1828	2	UInteger16	r/-	-	-	-
Actual diagnostic 2	6186	0x182A	2	UInteger16	r/-	-	-	-
Actual diagnostic 3	6188	0x182C	2	UInteger16	r/-	-	-	-
Previous diagnostics 1	6214	0x1846	2	UInteger16	r/-	-	-	-
Timestamp 1	6204	0x183C	4	UInteger32	r/-	-	-	-
Previous diagnostics 2	6216	0x1848	2	UInteger16	r/-	-	-	-
Timestamp 2	6205	0x183D	4	UInteger32	r/-	-	-	-
Previous diagnostics 3	6218	0x184A	2	UInteger16	r/-	-	-	-
Timestamp 3	6206	0x183E	4	UInteger32	r/-	-	-	-
Previous diagnostics 4	6220	0x184C	2	UInteger16	r/-	-	-	-
Timestamp 4	6207	0x183F	4	UInteger32	r/-	-	-	-
Previous diagnostics 5	6222	0x184E	2	UInteger16	r/-	-	-	-
Timestamp 5	6208	0x1840	4	UInteger32	r/-	-	-	-
Current output simulation	8210	0x2012	2	UInteger16	r/w	33004 = Off	33004 = Off 33005 = On	-
Current output simulation value	8211	0x2013	4	Float	r/w	3.58 mA	3.58 to 23 mA	-
Sensor simulation	3109	0x0C25	1	UInteger8	r/w	0 = Off	0 = Off 1 = On	-
Sensor simulation value	3104	0x0C20	4	Float	r/w	0 °C (32 °F)	-1E+20 to 1E+20 °C	-
Switch output simulation	2056	0x0808	2	UInteger16	r/w	0 = Disabled	0 = Disabled 33004 = Off 33006 = On	-
Sensor min value	3081	0x0C09	4	Float	r/-	-	-	-
Sensor max value	3080	0x0C08	4	Float	r/-	-	-	-
Lower boundary operating time sensor	3132	0x0C3C	4	UInteger32	r/-	-	-	-
Lower extended operation time sensor	3133	0x0C3D	4	UInteger32	r/-	-	-	-
Standard operating time sensor	3134	0x0C3E	4	UInteger32	r/-	-	-	-
Upper extended operating time sensor	3135	0x0C3F	4	UInteger32	r/-	-	-	-
Upper boundary operating time sensor	3136	0x0C40	4	UInteger32	r/-	-	-	-
Device temperature	4096	0x1000	4	Float	r/-	-	-	-
Device temperature min	4107	0x100B	4	Float	r/-	-	-	-
Device temperature max	4106	0x100A	4	Float	r/-	-	-	-

Identifier	Index (dec)	Index (hex)	Size (byte)	Data type	Access	Default value	Value range	Data storage
Lower boundary operating time device	4109	0x100D	4	UInteger32	r/-	-	-	-
Lower extended operation time device	4110	0x100E	4	UInteger32	r/-	-	-	-
Standard operating time device	4111	0x100F	4	UInteger32	r/-	-	-	-
Upper extended operating time device	4112	0x1010	4	UInteger32	r/-	-	-	-
Upper boundary operating time device	4113	0x1011	4	UInteger32	r/-	-	-	-
MDC Descriptor	16512	0x4080	11	Record	r/-	-	-	-

### 8.3.2 IO-Link-specific device data

Identifier	Index (dec)	Index (hex)	Size (byte)	Data type	Access	Default value
Serial number	21	0x0015	16	String	r/-	-
Product ID	19	0x0013	32	String	r/-	TM311
Product Name	18	0x0012	32	String	r/-	iTHERM CompactLine TM311
Product Text	20	0x0014	32	String	r/-	Compact thermometer
Vendor Name	16	0x0010	32	String	r/-	Endress+Hauser
Vendor Text	17	0x0011	32	String	r/-	People for Process Automation
Hardware Version	22	0x0016	8	String	r/-	-
Firmware version	23	0x0017	8	String	r/-	-
Device Access Locks	12	0x000C	2	Record	r/w	-

### 8.3.3 System commands



Identifier	Value (dec)	Value (hex)
Reset factory settings	130	0x82
Activate parametrization lock	160	0xA0
Deactivate parametrization lock	161	0xA1
Reset sensor min/max values	162	0xA2
Reset device temp. min/max values	163	0xA3
IO-Link 1.1 system test command 240	240	0xF0
IO-Link 1.1 system test command 241	241	0xF1
IO-Link 1.1 system test command 242	242	0xF2
IO-Link 1.1 system test command 243	243	0xF3

## 9 Commissioning

If an existing configuration is changed, measuring operation continues.

### 9.1 Post-installation check

Perform the following checks prior to commissioning the measuring point:

1. Perform the post-installation check using the checklist →  16.
2. Perform the post-connection check using the checklist →  18.

### 9.2 Configuring the measuring device

IO-Link functions and device-specific parameters are configured via the device's IO-Link communication.



Special configuration kits are available, e.g. the FieldPort SFP20. Every IO-Link device can be configured with it.



IO-Link devices are typically configured via the automation system (e.g. Siemens TIA Portal + Port Configuration Tool). The device supports IO-Link Data Storage, which enables easy device replacement.



## 10 Diagnostics and troubleshooting

### 10.1 General troubleshooting

 Due to the device's particular design, it cannot be repaired. However, it is possible to send the device in for inspection. →  29

Error	Possible cause	Solution
Device is not responding.	Supply voltage does not match the value indicated on the nameplate.	▶ Apply correct voltage.
	The polarity of the supply voltage is wrong.	▶ Correct the polarity of the supply voltage.
Device measures incorrectly.	The device has been incorrectly configured.	▶ Check and correct the parameter configuration.
	The device has been incorrectly connected.	▶ Check the pin assignment →  17.
	Incorrect device orientation.	▶ Install the device correctly →  12.
	Heat dissipation over the measuring point.	▶ Observe the installed length of the sensor.
No communication	Communication cable is not connected.	▶ Check wiring and cables.
	Communication cable is incorrectly attached to the IO-Link master.	
No transmission of process data.	There is an error in the device.	▶ Correct errors that are displayed as a diagnostic event.

### 10.2 Diagnostic information via communication interface

#### 10.2.1 Diagnostic message

The **Device Status** parameter shows the event category of the active diagnostic message with the highest priority. This category is displayed in the diagnostic list.

#### Status signals

The status signals provide information on the state and reliability of the device by categorizing the cause of the diagnostic information (diagnostic event). The status signals are categorized according to NAMUR Recommendation NE 107: F = Failure, C = Function Check, S = Out of Specification, M = Maintenance Required

Alphabetic character	Symbol	Event category	Meaning
<b>F</b>	⊗	Operating error	An operating error has occurred.
<b>C</b>	▽	Service mode	The device is in service mode (e.g. during a simulation).
<b>S</b>	△	Out of specification	The device is being operated outside its technical specifications (e.g. during warm-up or cleaning processes).
<b>M</b>	◇	Maintenance required	Maintenance is required.

## 10.3 Overview of the diagnostic information

Diagnostic message	Diagnostic behavior	IO-Link Event Qualifier	IO-Link Event Code	Event text	Reason	Corrective measure
F001	Alarm	IO-Link Error	0x1817	Device failure	Device fault	<ol style="list-style-type: none"> <li>Restart the device.</li> <li>Replace device.</li> </ol>
F004	Alarm	IO-Link Error	0x1818	Sensor defective	The sensor is defective (e.g.: sensor failure or sensor short-circuit)	<ul style="list-style-type: none"> <li>Replace device.</li> </ul>
S047	Warning	IO-Link Warning	0x1819	Sensor limit reached	Sensor limit has been reached	<ol style="list-style-type: none"> <li>Check sensor.</li> <li>Check process conditions.</li> </ol>
C401	Warning	IO-Link Notification	0x181F	Factory reset active	Factory reset is active	<ul style="list-style-type: none"> <li>Factory reset is active, please wait.</li> </ul>
C402	-	-	-	Initialization active	Initialization is active	<ul style="list-style-type: none"> <li>Initialization active, please wait.</li> </ul>
C485	Warning	IO-Link Warning	0x181A	Process variable simulation active	Simulation of the process variable is active	<ul style="list-style-type: none"> <li>Deactivate simulation.</li> </ul>
C491	Warning	IO-Link Warning	0x181B	Current output simulation active	Simulation of the current output is active	<ul style="list-style-type: none"> <li>Deactivate simulation.</li> </ul>
C494	Warning	IO-Link Warning	0x181C	Switch output simulation active	Simulation of the switch output is active	<ul style="list-style-type: none"> <li>Deactivate simulation.</li> </ul>
F537	Alarm	IO-Link Error	0x181D	Configuration invalid	Current range is invalid The difference between the 4mA value and 20mA value must be greater than or equal to 10°C.	<ol style="list-style-type: none"> <li>Check device configuration.</li> <li>Upload and download new configuration.</li> </ol>
					Switch points are invalid The switch point must be greater than or equal to the switchback point.	
S801	Warning	IO-Link Warning	0x181E	Supply voltage too low	Supply voltage too low	<ul style="list-style-type: none"> <li>Increase supply voltage.</li> </ul>
S804 <sup>1)</sup>	Alarm	-	-	Overload at switch output	Overload at the switch output	<ol style="list-style-type: none"> <li>Increase load resistance at switch output.</li> <li>Check the output.</li> <li>Replace device.</li> </ol>
S825	Warning	IO-Link Warning	0x1812	Operating temperature	Operating temperature of the electronics out of specification	<ol style="list-style-type: none"> <li>Check ambient temperature.</li> <li>Check process temperature.</li> </ol>
S844 <sup>2)</sup>	Warning	-	-	Process value out of specification	Process value is outside the specification	<ol style="list-style-type: none"> <li>Check process value.</li> <li>Check application.</li> <li>Check sensor.</li> </ol>

1) Diagnostic only possible in SIO mode

2) Diagnostic only possible in the 4 to 20mA mode.

### 10.3.1 Behavior of the device in the event of a fault

The diagnostic behavior of the device differs depending on the selected operating mode. Irrespective of the operating mode, all the diagnostic messages are saved in the event logbook, where they can be accessed as required.

### IO-Link

The device displays warnings and faults via IO-Link. All the device warnings and faults are for information purposes only and do not have a safety function. The errors diagnosed by the device are displayed via IO-Link in accordance with NE107. A distinction must be made between the following types of diagnostic behavior in this context:

- **Warning**  
The device continues measuring in the event of warning-type diagnostic behavior. The output signal is not affected (exception: simulation of the process variable is active).
- **Alarm**
  - The device does **not** continue measuring if this type of error occurs. The output signal adopts its fault state (value in the event of an error - see the following section).
  - The PDValid Flag indicates that the process data are invalid.
  - The fault state is displayed via IO-Link.

### Switch output

- **Warning**  
The switch output remains in the state defined by the switch points.
- **Alarm**  
The switch output changes to the **open** state.

### 4 to 20 mA

- **Warning**  
The current output is not affected.
- **Alarm**  
The current output adopts the configured failure current.

The behavior of the output in the event of a failure is regulated in accordance with NAMUR NE43.

-  The failure current can be set.
- The selected failure current is used for all errors.

## 10.4 Diagnostic list

If two or more diagnostic events are pending simultaneously, only the 3 diagnostic messages with the highest priority are shown in the diagnostic list. The status signal dictates the priority in which the diagnostic messages are displayed. The following order of priority applies: F, C, S, M. If two or more diagnostic events with the same status signal are active simultaneously, the numerical order of the event number dictates the order of priority in which the events are displayed, e.g. F042 appears before F044 and before S044.

## 10.5 Event logbook

The diagnostic messages are shown in chronological order in the **Event logbook**. In addition, a timestamp is saved with every diagnostic message. This timestamp is referenced to the operating time counter.

## 11 Maintenance

No special maintenance work is required.

### 11.1 Cleaning

The device must be cleaned whenever necessary. Cleaning can also be done when the device is installed (e.g. CIP Cleaning in Place / SIP Sterilization in Place). When cleaning the device, care must be taken to ensure that it is not damaged.

#### NOTICE

##### **Avoid damage to the device and the system**

- ▶ Pay attention to the specific IP code when cleaning.

### 11.2 Services

Service	Description
Calibration	RTD inserts may drift depending on the application. Regular recalibration to verify accuracy is recommended. The calibration can be performed by the manufacturer or by qualified technical staff using calibration devices onsite.

## 12 Repair

The design of the device is such that it cannot be repaired.

### 12.1 Spare parts

Spare parts currently available for your product can be found online at: [http://www.products.endress.com/spareparts\\_consumables](http://www.products.endress.com/spareparts_consumables). Always quote the serial number of the device when ordering spare parts!

Type	Order number
Plug screw fitting G1/2 1.4435	60022519
Spare part kit, pressure screw TK40 G1/2 d6	71217633
Weld-in adapter G3/4, d=50, 316L, 3.1	52018765
Weld-in adapter G3/4, d=29, 316L, 3.1	52028295
Welding boss for G1/2" sealing system	60021387
Weld-in adapter M12x1.5 1.4435&316L	71405560
O-ring 14.9x2.7 VMQ, FDA, 5 pieces	52021717
Weld-in adapter G3/4, d=55, 316L	52001052
Weld-in adapter G3/4, 316L, 3.1	52011897
O-ring 21.89x2.62 VMQ, FDA, 5 pieces	52014473
Weld-in adapter G1, d=60, 316L	52001051
Weld-in adapter G1, d=60, 316L, 3.1	52011896
Weld-in adapter G1, d=53, 316L, 3.1	71093129
O-ring 28.17x3.53 VMQ, FDA, 5 pieces	52014472
iTHERM TK40 compression fitting	TK40-
Spare part kit, seal TK40	XPT0001-
iTHERM TT411 thermowell	TT411-

### 12.2 Return

The requirements for safe device return can vary depending on the device type and national legislation.

1. Refer to the web page for information:  
<http://www.endress.com/support/return-material>  
↳ Select the region.
2. Return the device if repairs or a factory calibration are required, or if the wrong device was ordered or delivered.

### 12.3 Disposal

The device contains electronic components and must therefore be disposed of as electronic waste. Please pay particular attention to the local regulations governing waste disposal in your country. Ensure proper separation and reuse of the device components where possible.

## 13 Accessories

All dimensions in mm (in).

### 13.1 Device-specific accessories

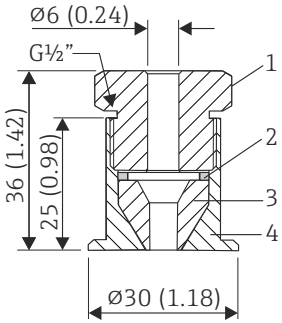
Accessories	Description
<p>Welding boss with sealing taper</p>  <p style="text-align: right; font-size: small;">A0048610</p> <ol style="list-style-type: none"> <li>1 Pressure screw, 303/304, width across flats 24 mm</li> <li>2 Washer, 303/304</li> <li>3 Sealing taper, PEEK</li> <li>4 Collar welding boss, 316L</li> </ol>	<ul style="list-style-type: none"> <li>■ Collar welding boss movable with sealing taper, washer and pressure screw G<math>\frac{1}{2}</math>"</li> <li>■ Material of parts in contact with the process 316L, PEEK</li> <li>■ Max. process pressure 10 bar (145 psi)</li> <li>■ Order number with pressure screw 51004751</li> <li>■ Order number without pressure screw 51004752</li> </ul>

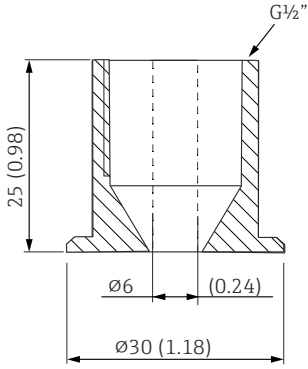
Accessories	Description
<p>Collar welding boss</p>  <p style="text-align: right; font-size: small;">A0020710</p>	<ul style="list-style-type: none"> <li>■ Material of parts in contact with the process 316L</li> <li>■ Order number without pressure screw 51004752</li> </ul>

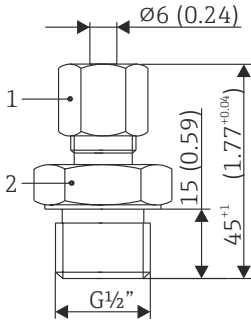
Accessories	Description
<p data-bbox="619 253 799 282">Compression fitting</p>  <p data-bbox="858 636 911 651">A0048609</p> <p data-bbox="523 667 608 712">1 AF14 2 AF27</p>	<ul style="list-style-type: none"> <li data-bbox="927 253 1385 282">▪ Movable clamping ring, process connection G<math>\frac{1}{2}</math>"</li> <li data-bbox="927 282 1501 333">▪ Material of compression fitting and parts in contact with the process, 316L</li> <li data-bbox="927 333 1430 385">▪ Order number TK40-BADA3C (other versions can be configured in the TK40 structure)</li> </ul>

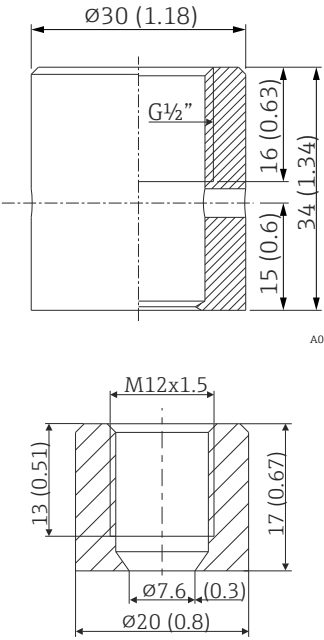
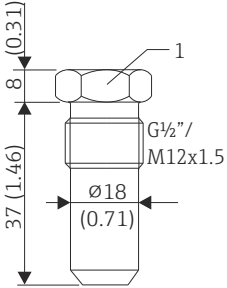
Accessories	Description
<p data-bbox="523 831 895 882">Welding boss with sealing taper (metal-metal)</p>  <p data-bbox="858 1240 911 1256">A0006621</p> <p data-bbox="858 1554 911 1570">A0018236</p>	<ul style="list-style-type: none"> <li data-bbox="927 831 1326 860">▪ Welding boss for G<math>\frac{1}{2}</math>" or M12x1.5 thread</li> <li data-bbox="927 860 1150 889">▪ Metal-sealing; conical</li> <li data-bbox="927 889 1481 918">▪ Material of parts in contact with the process 316L/1.4435</li> <li data-bbox="927 918 1305 947">▪ Max. process pressure 16 bar (232 PSI)</li> <li data-bbox="927 947 1238 976">▪ Order number 71424800 (G<math>\frac{1}{2}</math>" )</li> <li data-bbox="927 976 1286 1005">▪ Order number 71405560 (M12x1.5)</li> </ul>
<p data-bbox="647 1585 767 1615">Dummy plug</p>  <p data-bbox="858 1935 911 1951">A0045726</p> <p data-bbox="523 1966 608 1995">1 AF22</p>	<ul style="list-style-type: none"> <li data-bbox="927 1585 1453 1637">▪ Dummy plug for G<math>\frac{1}{2}</math>" or M12x1.5 conical metal-sealing welding boss</li> <li data-bbox="927 1637 1190 1666">▪ Material: SS 316L/1.4435</li> <li data-bbox="927 1666 1238 1695">▪ Order number 60022519 (G<math>\frac{1}{2}</math>" )</li> <li data-bbox="927 1695 1286 1724">▪ Order number 60021194 (M12x1.5)</li> </ul>

### 13.1.1 Weld-in adapter

Weld-in adapter						
	G 3/4", d=29 for pipe-mounting	G 3/4", d=50 for vessel-mounting	G 3/4", d=55 with flange	G 1", d=53 without flange	G 1", d=60 with flange	G 1" adjustable
Material	316L (1.4435)	316L (1.4435)	316L (1.4435)	316L (1.4435)	316L (1.4435)	316L (1.4435)
Roughness $\mu\text{m}$ ( $\mu\text{in}$ ) process side	$\leq 1.5$ (59.1)	$\leq 0.8$ (31.5)	$\leq 0.8$ (31.5)	$\leq 0.8$ (31.5)	$\leq 0.8$ (31.5)	$\leq 0.8$ (31.5)

- i** Maximum process pressure for the weld-in adapters:
- 25 bar (362 PSI) at maximum 150 °C (302 °F)
  - 40 bar (580 PSI) at maximum 100 °C (212 °F)

## 13.2 Communication-specific accessories

Accessories	Description
FieldPort SFP20	<b>Mobile configuration tool for all IO-Link devices:</b> <ul style="list-style-type: none"> <li>■ Pre-installed device and CommDTMs in FieldCare</li> <li>■ Pre-installed device and CommDTMs in FieldXpert</li> <li>■ M12 connection for IO-Link field devices</li> </ul>

### 13.2.1 Coupling

Accessories	Description
<ul style="list-style-type: none"> <li>■ M12x1 coupling; elbowed, for termination of connecting cable by user</li> <li>■ Connection to M12x1 housing connector</li> <li>■ Body materials PBT/PA,</li> <li>■ Cap-nut GD-Zn, nickel-plated</li> <li>■ IP67 degree of protection (fully locked)</li> <li>■ Order number 51006327</li> <li>■ Voltage: max. 250 V</li> <li>■ Current carrying capacity: max. 4 A</li> <li>■ Temperature: -40 to 85 °C</li> </ul>	<p style="text-align: right;">A0020722</p>



Accessories	Description
<ul style="list-style-type: none"> <li>▪ PVC cable, 4 x 0.34 mm<sup>2</sup> (22 AWG) with M12x1 coupling, elbow plug, screw plug, length 5 m (16.4 ft)</li> <li>▪ IP67 degree of protection</li> <li>▪ Order number 52024216</li> <li>▪ Voltage: max. 250 V</li> <li>▪ Current carrying capacity: max. 4 A</li> <li>▪ Temperature: -25 to 70 °C</li> </ul> <p>Wire colors:</p> <ul style="list-style-type: none"> <li>▪ 1 = BN brown</li> <li>▪ 2 = WH white</li> <li>▪ 3 = BU blue</li> <li>▪ 4 = BK black</li> </ul>	<p>A0020723</p>

Accessories	Description
<ul style="list-style-type: none"> <li>▪ PVC cable, 4 x 0.34 mm<sup>2</sup> (22 AWG) with M12x1 coupling nut made of epoxy coated zinc, straight socket contact, screw plug, 5 m (16.4 ft)</li> <li>▪ IP67 degree of protection</li> <li>▪ Order number 71217708</li> <li>▪ Voltage: max. 250 V</li> <li>▪ Current carrying capacity: max. 4 A</li> <li>▪ Temperature: -20 to 105 °C</li> </ul> <p>Wire colors:</p> <ul style="list-style-type: none"> <li>▪ 1 = BN brown</li> <li>▪ 2 = WH white</li> <li>▪ 3 = BU blue</li> <li>▪ 4 = BK black</li> </ul>	<p>A0020725</p>

### 13.2.2 Adapter cables



**i** If a TMR3x is replaced by a TM311, the pin assignment must be changed, as the IO-Link standard requires another assignment than that used in TMR3x devices. Either the wiring is changed in the cabinet or the adapter cable is used for the pin assignment between the device and the existing wiring.



Accessories	Description
<ul style="list-style-type: none"> <li>▪ Cable: PVC; 2-pin; 2 x 0.34 mm<sup>2</sup> (AWG22) shielded</li> <li>▪ Cable length ~ 100 mm (3.94 in) without socket and connector</li> <li>▪ Color: black</li> <li>▪ Connector 1: M12, 4-pin, A-coded, socket, straight</li> <li>▪ Connector 2: M12, 4-pin, A-coded, connector, straight</li> <li>▪ Metal parts: stainless steel</li> <li>▪ Voltage: max. 60 V<sub>DC</sub></li> <li>▪ Current carrying capacity: max. 4 A</li> <li>▪ Degree of protection: IP66, IP67 and IP69 in accordance with IEC 60529 (when connected); NEMA 6P</li> <li>▪ Temperature: -40 to +85 °C (-40 to +185 °F)</li> <li>▪ Order number 71449142</li> </ul>	<p>A0040288</p> <p>A M12 socket          B M12 connector          L 200 mm (7.87 in)</p>

### 13.3 Service-specific accessories

Accessories	Description
Applicator	<p>Software for selecting and sizing Endress+Hauser measuring devices:</p> <ul style="list-style-type: none"> <li>■ Calculation of all the necessary data for identifying the optimum measuring device: e.g. pressure loss, accuracy or process connections.</li> <li>■ Graphic illustration of the calculation results</li> </ul> <p>Administration, documentation and access to all project-related data and parameters over the entire life cycle of a project.</p> <p>Applicator is available: Via the Internet: <a href="https://portal.endress.com/webapp/applicator">https://portal.endress.com/webapp/applicator</a></p>
Configurator	<p>Product Configurator - the tool for individual product configuration</p> <ul style="list-style-type: none"> <li>■ Up-to-the-minute configuration data</li> <li>■ Depending on the device: Direct input of measuring point-specific information such as measuring range or operating language</li> <li>■ Automatic verification of exclusion criteria</li> <li>■ Automatic creation of the order code and its breakdown in PDF or Excel output format</li> <li>■ Ability to order directly in the Endress+Hauser Online Shop</li> </ul> <p>The Configurator is available on the Endress+Hauser website at: <a href="http://www.endress.com">www.endress.com</a> -&gt; Click "Corporate" -&gt; Select your country -&gt; Click "Products" -&gt; Select the product using the filters and search field -&gt; Open product page -&gt; The "Configure" button to the right of the product image opens the Product Configurator.</p>
W@M	<p>Life cycle management for your plant</p> <p>W@M offers assistance with a wide range of software applications over the entire process: from planning and procurement to the installation, commissioning and operation of the measuring devices. All the relevant information is available for every measuring device over the entire life cycle, such as the device status, device-specific documentation, spare parts etc.</p> <p>The application already contains the data of your Endress+Hauser device.</p> <p>Endress+Hauser also takes care of maintaining and updating the data records.</p> <p>W@M is available: Via the Internet: <a href="http://www.endress.com/lifecyclemanagement">www.endress.com/lifecyclemanagement</a></p>

### 13.4 System components

Accessories	Description
IO-Link master BL20	IO-Link master from Turck for DIN rails supports PROFINET, EtherNet/IP and Modbus TCP. With web server for easy configuration.
RIA16 field indicator	<p>The field indicator presents the analog measuring signal on the display. The LC display shows the current measured value in digital form and as a bar graph indicating a limit value violation. The indicator is looped into the 4 to 20 mA circuit and gets the required energy from there.</p> <p> For details, see Technical Information TI00144R</p>
RIA15 field indicator	<p>Field indicator for looping into 4 to 20 mA, panel mounting</p> <p> For details, see Technical Information TI00143K</p>

Accessories	Description
RIA14 field indicator	Field indicator for looping into 4 to 20 mA, optionally available with Ex d approval.  For details, see document TI00143R
Accessories	Description
RN22/RN42	RN221: 1- or 2-channel active barrier for separation of 0/4 to 20 mA standard signal circuits, optionally available as a signal duplicator, 24 V DC. HART-transparent RN42: 1-channel active barrier with wide range power supply for safe separation of 0/4 to 20 mA standard signal circuits, HART-transparent  For details <ul style="list-style-type: none"> <li>■ Technical Information RN22 -&gt; TI01515K</li> <li>■ Technical Information RN42 -&gt; TI01584K</li> </ul>

## 14 Technical data

### 14.1 Input

Measuring range	Pt100 (TF) basic	-50 to +150 °C (-58 to +302 °F)
	iTHERM TipSens	-50 to +200 °C (-58 to +392 °F)

### 14.2 Output

Output signal      Version without integrated electronics

Sensor output	Pt100, 4-wire connection, class A
---------------	-----------------------------------

4 to 20 mA version

Analog output	4 to 20 mA; variable measuring range
Digital output	C/Q (IO-Link or switch output)

IO-Link version

Analog output	4 to 20 mA; measuring range 0 to 150 °C (32 to 302 °F)
Digital output	C/Q (IO-Link or switch output)

Failure information      Failure information is generated if the measuring information is missing or not valid. The device displays the three diagnostic messages with the highest priority.

In the IO-Link mode, the device transmits all the failure information digitally.

In the 4 to 20 mA mode, the device transmits the failure information according to NAMUR NE43:

Switch output	The switch output switches to <b>open</b> in the fault state.
---------------	---

Underranging	Linear drop from 4.0 to 3.8 mA
Overranging	Linear increase from 20.0 to 20.5 mA
Failure e.g. sensor defective	≤ 3.6 mA ( <b>low</b> ) or ≥ 21 mA ( <b>high</b> ) can be selected The <b>high</b> alarm setting can be set between 21.5 mA and 23 mA, thus providing the flexibility needed to meet the requirements of various control systems.

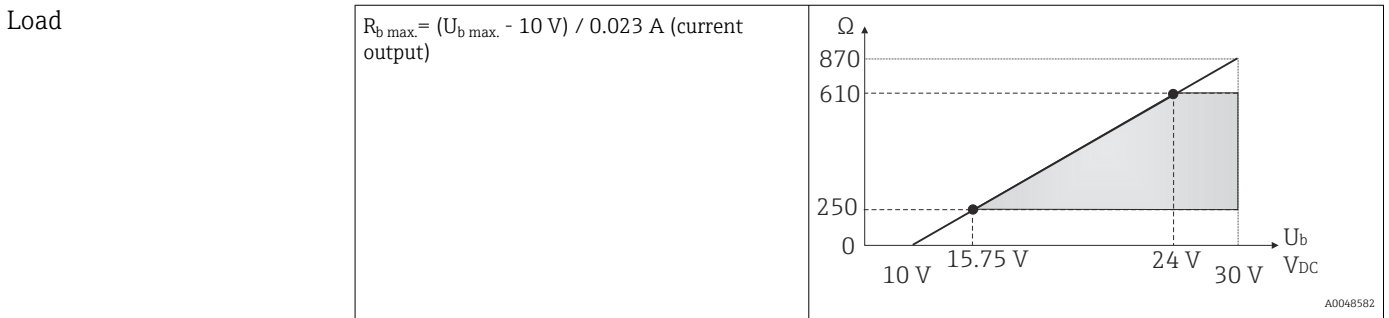

Linearization/transmission behavior      Temperature - linear

Protocol-specific data      → 19

### 14.3 Power supply

Supply voltage	Electronic version	Supply voltage
	IO-Link/ 4 to 20 mA	$U_b = 10 \text{ to } 30 \text{ V}_{DC}$ , protected against reverse polarity  IO-Link communication is guaranteed only if the supply voltage is at least 15 V.  If the supply voltage is < 15 V, the device displays a diagnostic message and deactivates the switch output.

The device must be operated with a type-examined transmitter power supply unit. Additional overvoltage protection is required for marine applications.

- Power supply failure
- To meet electrical safety according to CAN/CSA-C22.2 No. 61010-1 or UL 61010-1, the device may only be powered by a power supply unit with a limited energy electric circuit in accordance with UL/EN/IEC 61010-1 chapter 9.4 or Class 2 according to UL 1310, "SELV or Class 2 circuit".
  - Behavior in the event of overvoltage (> 30 V)  
The device works continuously up to 35 V<sub>DC</sub> without any damage. If the supply voltage is exceeded, the specified characteristics are no longer guaranteed.
  - Behavior in the event of undervoltage  
If the supply voltage falls below the minimum value ~ 7 V, the device switches off in a defined manner (status as if not supplied with power).

Maximum current consumption      ≤ 23 mA for 4 to 20 mA

Switch-on delay      2 s

Overvoltage protection      To protect against overvoltage in the power supply and signal/communication cables for the thermometer electronics, the manufacturer offers the HAW562 surge arrester for DIN rail mounting.

For more detailed information, see Technical Information HAW562 surge arrester (TI01012K) .

## 14.4 Performance characteristics

Reference operating conditions	<b>Adjustment temperature (ice bath)</b>	0 °C (32 °F) for sensor
	<b>Ambient temperature range</b>	25 °C ± 3 °C (77 °F ± 5 °F) for electronics
	<b>Supply voltage</b>	24 V <sub>DC</sub> ± 10 %
	<b>Relative humidity</b>	< 95 %

Maximum measured error In accordance with DIN EN 60770 and the reference conditions specified above. The measured error data correspond to ±2 σ (Gaussian distribution). The data include non-linearities and repeatability.

Measured error (according to IEC 60751) in °C = 0.15 + 0.002 |T|

 |T| = Numerical value of the temperature in °C without regard to algebraic sign.

### Thermometer without electronics

Standard	Description	Measuring range	Measured error (±)	
			Maximum <sup>1)</sup>	Based on measured value <sup>2)</sup>
IEC 60751	Pt100 Cl. A	-50 to +200 °C (-58 to +392 °F)	0.55 °C (0.99 °F)	ME = ± (0.15 °C (0.27 °F) + 0.002 *  T )

- 1) Maximum measured error for the specified measuring range.
- 2) Deviations from maximum measured error possible due to rounding.

 In order to obtain the maximum tolerances in °F, the results in °C must be multiplied by a factor of 1.8.

### Thermometer with electronics

Standard	Description	Measuring range	Measured error (±)		
			Maximum	Based on measured value	D/A <sup>2)</sup>
IEC 60751	Pt100 Cl. A	-50 to +200 °C (-58 to +392 °F)	≤ 0.48 °C (0.86 °F)	ME = ± (0.215 °C (0.39 °F) + 0.134% * (MV - LRV))	0.05 % (≅ 8 μA)

- 1) Measured value transmitted via IO-Link.
- 2) Percentages based on the configured span of the analog output signal.

### Thermometer with electronics and sensor-transmitter-matching / increased accuracy

Standard	Description	Measuring range	Measured error (±)		
			Maximum	Based on measured value	D/A <sup>2)</sup>
IEC 60751	Pt100 Cl. A	-50 to +200 °C (-58 to +392 °F)	≤ 0.14 °C (0.25 °F)	ME = ± (0.127 °C (0.23 °F) + 0.0074% * (MV - LRV))	0.05 % (≅ 8 μA)

- 1) Measured value transmitted via IO-Link.
- 2) Percentages based on the configured span of the analog output signal.

MV = measured value

LRV = lower range value of the sensor in question

$$\text{Total measured error of transmitter at current output} = \sqrt{(\text{Measured error digital}^2 + \text{Measured error D/A}^2)}$$

Sample calculation with Pt100, measuring range 0 to +150 °C (+32 to +302 °F), ambient temperature +25 °C (+77 °F), supply voltage 24 V and sensor-transmitter matching:

Measured error digital = 0.127 °C (0.229 °F) + 0.0074 % x [150 °C (302 °F) - (-50 °C (-58 °F))]:	0.14 °C (0.25 °F)
Measured error D/A = 0.05 % x 150 °C (302 °F)	0.08 °C (0.14 °F)
<b>Measured error digital value (IO-Link):</b>	0.14 °C (0.25 °F)
<b>Measured error analog value (current output):</b> $\sqrt{(\text{Measured error digital}^2 + \text{Measured error D/A}^2)}$	0.16 °C (0.29 °F)

Sample calculation with Pt100, measuring range 0 to +150 °C (+32 to +302 °F), ambient temperature +35 °C (+95 °F), supply voltage 30 V:

Measured error digital = 0.215 °C (0.387 °F) + 0.134 % x [150 °C (302 °F) - (-50 °C (-58 °F))]:	0.48 °C (0.86 °F)
Measured error D/A = 0.05 % x 150 °C (302 °F)	0.08 °C (0.14 °F)
Influence of ambient temperature (digital) = (35 - 25) x (0.004 % x 200 °C (360 °F)), at least 0.008 °C (0.014 °F)	0.08 °C (0.14 °F)
Influence of ambient temperature (D/A) = (35 - 25) x (0.003 % x 150 °C (302 °F))	0.05 °C (0.09 °F)
Influence of supply voltage (digital) = (30 - 24) x (0.004 % x 200 °C (360 °F)), at least 0.008 °C (0.014 °F)	0.05 °C (0.09 °F)
Influence of supply voltage (D/A) = (30 - 24) x (0.003 % x 150 °C (302 °F))	0.03 °C (0.05 °F)
<b>Measured error digital value (IO-Link):</b> $\sqrt{(\text{Measured error digital}^2 + \text{Influence of ambient temperature (digital)}^2 + \text{Influence of supply voltage (digital)}^2)}$	0.49 °C (0.88 °F)
<b>Measured error analog value (current output):</b> $\sqrt{(\text{Measured error digital}^2 + \text{Measured error D/A}^2 + \text{Influence of ambient temperature (digital)}^2 + \text{Influence of ambient temperature (D/A)}^2 + \text{Influence of supply voltage (digital)}^2 + \text{Influence of supply voltage (D/A)}^2)}$	0.50 °C (0.90 °F)

Long-term drift

	1 month	3 months	6 months	1 year	3 years	5 years
Digital output IO-Link	± 9 mK	± 15 mK	± 19 mK	± 23 mK	± 28 mK	± 31 mK
Current output Measuring range -50 to +200 °C (-58 to +360 °F)	± 2.5 µA	± 4.3 µA	± 5.4 µA	± 6.4 µA	± 8.0 µA	± 8.8 µA

Operating influences

The measured error data correspond to ±2 σ (Gaussian distribution).

Standard	Designation	Ambient temperature Influence (+-) per 1 °C (1.8 °F) change		Supply voltage Influence (+-) per 1 V change		
		Digital <sup>1)</sup>	D/A <sup>2)</sup>	Digital <sup>1)</sup>	D/A <sup>2)</sup>	
		Maximum <sup>3)</sup>	Based on measured value <sup>4)</sup>	Maximum <sup>3)</sup>	Based on measured value <sup>4)</sup>	
IEC 60751	Pt100 Cl. A	0.014 °C (0.025 °F)	0.004 % * (MV - LRV), min. 0.008 °C (0.0144 °F)	0.003 % (≅0.48 µA)	0.014 °C (0.025 °F) 0.004 % * (MV - LRV), min. 0.008 °C (0.0144 °F)	0.003 % (≅0.48 µA)

- 1) Measured value transmitted via IO-Link.
- 2) Percentages based on the configured span of the analog output signal.
- 3) Maximum measured error for the specified measuring range.
- 4) Deviations from maximum measured error possible due to rounding.

MV = Measured value

LRV = Lower range value of relevant sensor

Total measured error of transmitter at current output =  $\sqrt{(\text{Measured error digital}^2 + \text{Measured error D/A}^2)}$

Response time  $T_{63}$  and  $T_{90}$  Tests in water at 0.4 m/s (1.3 ft/s) according to IEC 60751; temperature changes in increments of 10 K. Response times measured for the version without electronics.

*Response time without heat transfer paste*

Design	Sensor	t <sub>63</sub>	t <sub>90</sub>
6 mm direct contact, straight tip	Pt100 (TF) basic	5 s	< 20 s
6 mm direct contact, straight tip	iTHERM TipSens	1 s	1.5 s
6 mm thermowell, straight tip (4.3 × 20 mm)	iTHERM TipSens	1 s	3 s

*Response time with heat transfer paste <sup>1)</sup>*

Design	Sensor	t <sub>63</sub>	t <sub>90</sub>
6 mm thermowell, straight tip (4.3 × 20 mm)	iTHERM TipSens	1 s	2.5 s

1) Between the insert and the thermowell

## 14.5 Environment

Ambient temperature range	T <sub>a</sub>	-40 to +85 °C (-40 to +185 °F)
---------------------------	----------------	--------------------------------

Storage temperature  Pack the device so that it is reliably protected against impact when it is stored (and transported). The original packaging offers the best protection.

T <sub>s</sub>	-40 to +85 °C (-40 to +185 °F)
----------------	--------------------------------

Operating altitude Up to 2 000 m (6 600 ft) above sea level

Climate class In accordance with IEC/EN 60654-1, climate class Dx, class 4K4H

Degree of protection As per IEC/EN 60529 IP69

 Depends on the degree of protection of the connection cable →  32

Shock and vibration resistance The thermometer meets the requirements of IEC 60751, which specifies shock and vibration resistance of 3 g in the 10 to 500 Hz range.

Electromagnetic compatibility (EMC) EMC in accordance with all the relevant requirements of the IEC/EN 61326 series and NAMUR Recommendation EMC (NE21). For details, refer to the Declaration of Conformity.



- Maximum measured error under EMC tests: < 1 % of the span
- Interference immunity according to IEC/EN 61326 series, requirements for industrial fields
- Interference emission according to IEC/EN 61326 series, Class B equipment

**IO-Link**

Only the requirements of IEC/EN 61131-9 are met in I/O-Link mode.

 The connection between the IO-Link master and thermometer is via an unshielded 3-wire cable, maximum 20 m (65.6 ft) in length.

**4 to 20 mA**

Electromagnetic compatibility in accordance with all the relevant requirements of the IEC/EN 61326 series and NAMUR Recommendation EMC (NE21).

 For more information, see the Declaration of Conformity.

1. With a connection cable length of 30 m (98.4 ft):  
always use a shielded cable.
2. The use of shielded connection cables is generally recommended.

Electrical safety

- Protection class III
- Overvoltage category II
- Pollution level 2

## 14.6 Mechanical construction

Design, dimensions

All dimensions in mm (in). The design of the thermometer depends on the thermowell version used:

- Thermometer without thermowell
- Thermowell diameter 6 mm (¼ in)
- T-piece and corner-piece thermowell version as per DIN 11865/ASME BPE 2012 for welding in

 Various dimensions, such as the immersion length U for example, are variable values and are therefore indicated as items in the following dimensional drawings.

*Variable dimensions:*

Item	Description
B	Thermowell bottom thickness
E	Extension neck length, optional
T	Length of thermowell lagging, pre-defined, depending on the thermowell version
U	Variable immersion length, depending on the configuration

**Without thermowell**

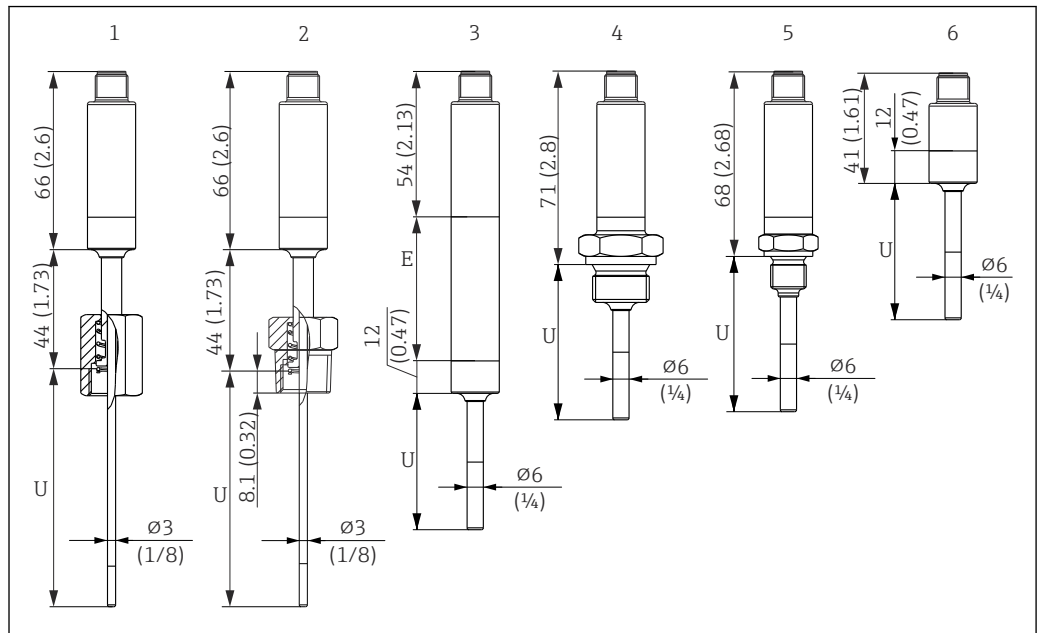

A0040023

- 1 Thermometer with spring-loaded cap-nut, G3/8" thread 3 mm for existing thermowell
- 2 Thermometer with spring-loaded NPT½" male thread 3 mm for existing thermowell
- 3 Thermometer without process connection for compression fitting, with extension neck
- 4 Thermometer with G½" male thread
- 5 Thermometer with G¼" male thread
- 6 Thermometer without electronics

**i** When using an extension neck, the overall length of the device always increases by the length in question, E = 50 mm (1.97 in), regardless of the process connection.

Pay attention to the following equations when calculating the immersion length U for an existing thermowell:

Version 1 (G3/8" cap-nut)	$U = U_{(\text{thermowell})} + T_{(\text{thermowell})} + 3 \text{ mm} - B_{(\text{thermowell})}$
Version 2 (NPT½" male thread)	$U = U_{(\text{thermowell})} + T_{(\text{thermowell})} - 5 \text{ mm} (-8 \text{ mm screw-in depth} + 3 \text{ mm spring travel}) - B_{(\text{thermowell})}$

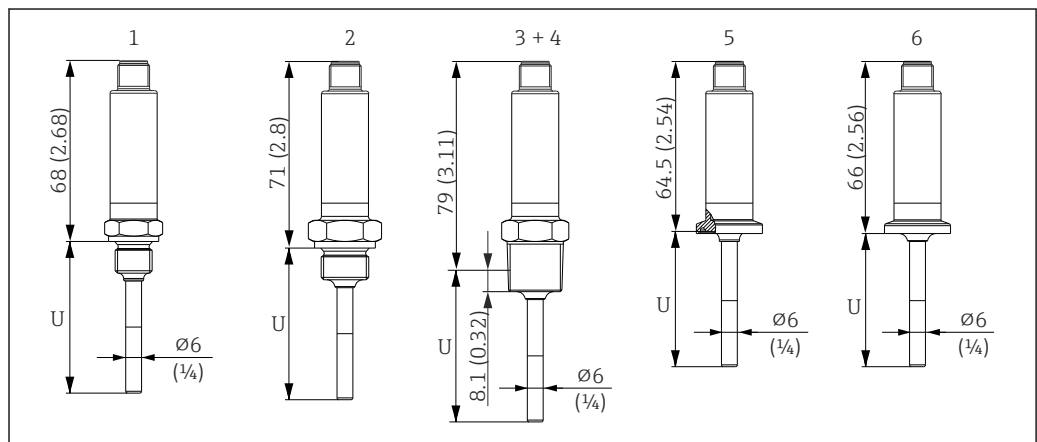

A0040267

- 1 Thermometer with M14 male thread
- 2 Thermometer with M18 male thread
- 3 Thermometer with NPT½" male thread
- 4 Thermometer with NPT¼" male thread
- 5 Thermometer with Microclamp, DN18 (0.75")
- 6 Thermometer with Tri-Clamp, DN18 (0.75")

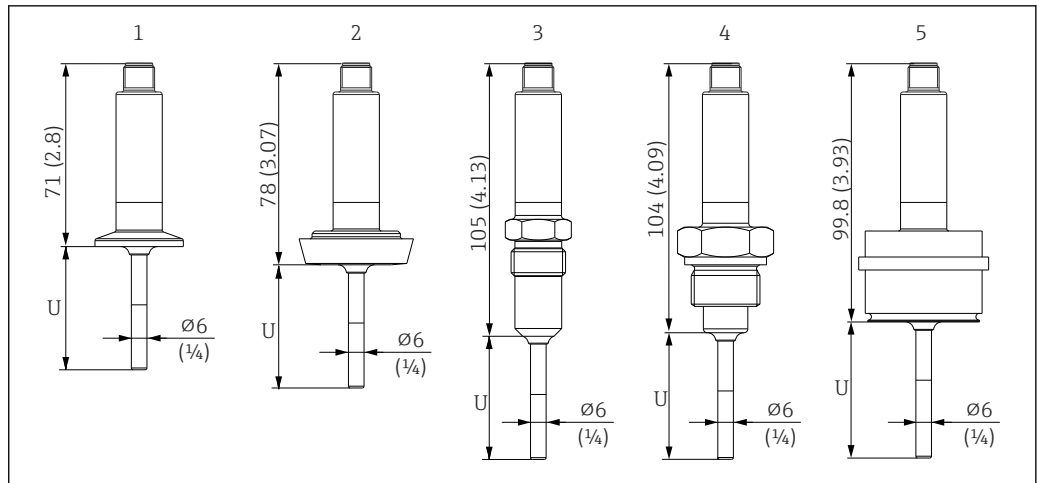

A0040024

- 1 Thermometer with Clamp ISO2852 for DN12 to 21.3, DN25 to 38, DN40 to 51
- 2 Thermometer with milk pipe connection DIN11851 for DN25/DN32/DN40/DN50
- 3 Thermometer with metal sealing system G $\frac{1}{2}$ "
- 4 Thermometer with G $\frac{3}{4}$ " male thread ISO228 for FTL31/33/20/50 Liquiphant adapter
- 5 Thermometer with D45 process adapter

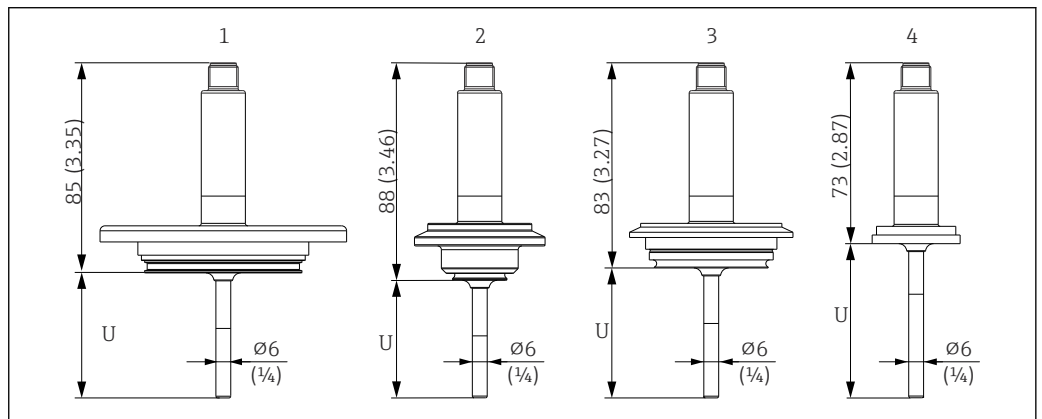

A0040268

- 1 Thermometer with APV in-line, DN50
- 2 Thermometer with Varivent type B, D 31 mm
- 3 Thermometer with Varivent type F, D 50 mm and Varivent type N, D 68 mm
- 4 Thermometer with SMS 1147, DN25/DN38/DN51

**With compression fitting**

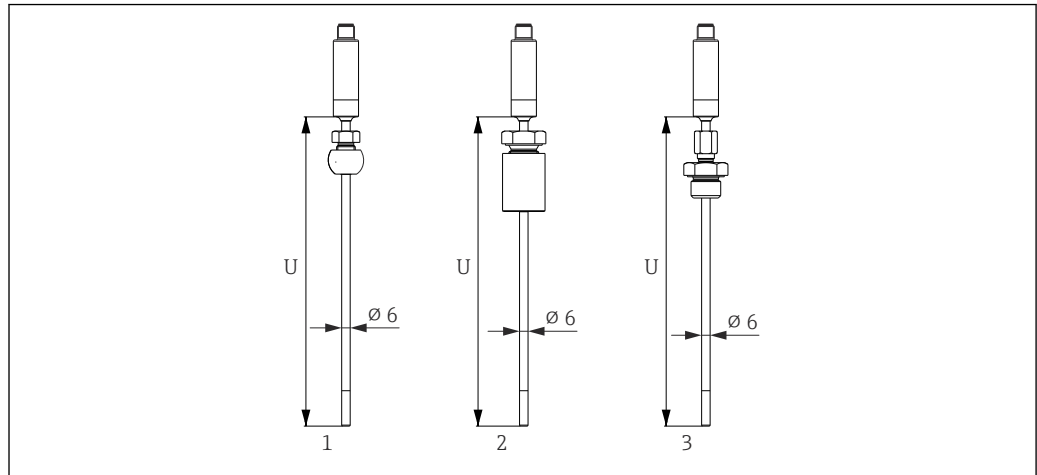

A0040025

- 1 Thermometer with compression fitting TK40 spherical, PEEK/316L, sleeve, Ø 25 mm, for welding in
- 2 Thermometer with compression fitting TK40 cylindrical, Elastosil sleeve, Ø 25 mm, for welding in
- 3 Thermometer with compression fitting G 1/2" external thread, TK40-BADA3C, 316L

**With thermowell diameter 6 mm (1/4 in)**

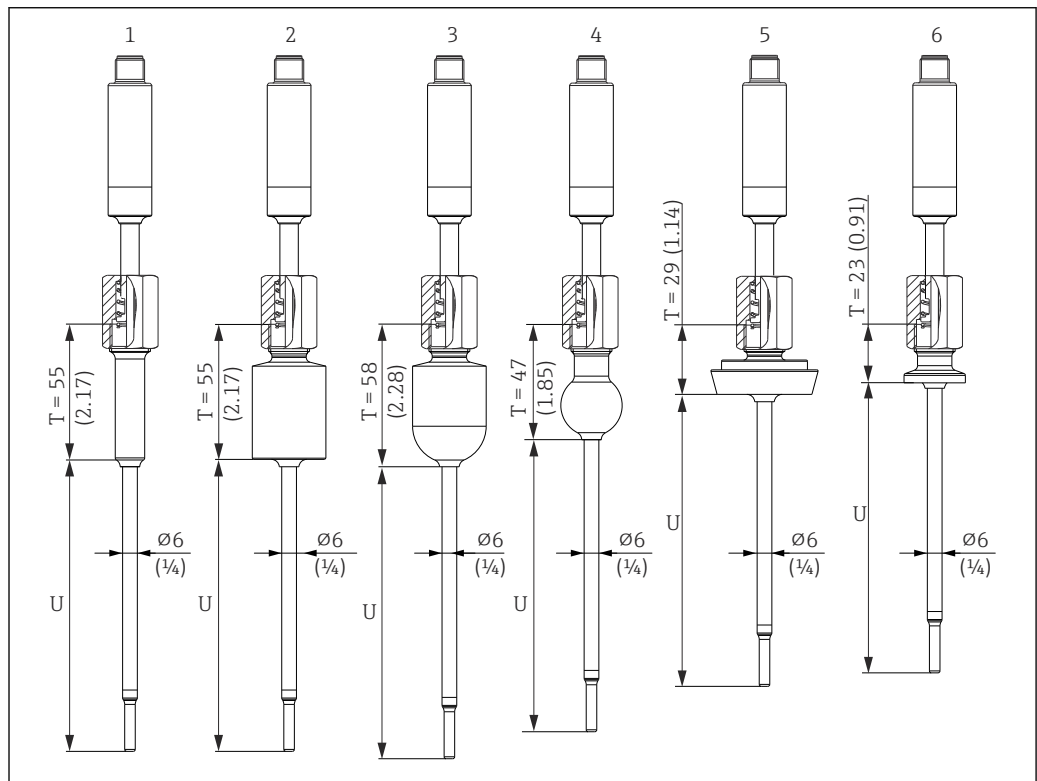

A0040026

- 1 Thermometer with weld-in adapter cylindrical, D 12 x 40 mm/40mm
- 2 Thermometer with weld-in adapter cylindrical, D 30 x 40 mm
- 3 Thermometer with weld-in adapter spherical-cylindrical, D 30 x 40 mm
- 4 Thermometer with weld-in adapter spherical, D 25 mm
- 5 Thermometer with milk pipe connection DIN11851, DN25/DN32/DN40
- 6 Thermometer with Microclamp, DN18 (0.75")

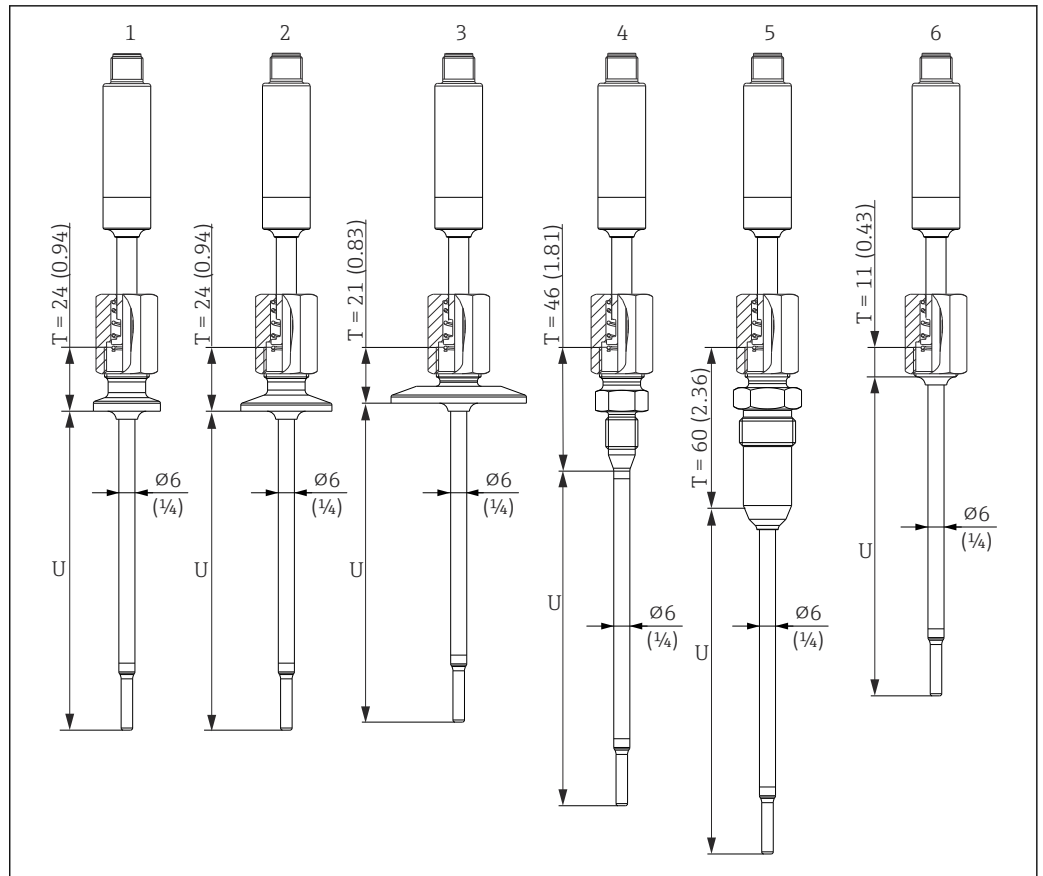

A0040027

- 1 Thermometer with Tri-Clamp version DN18
- 2 Thermometer with Clamp version DN12 to 21.3
- 3 Thermometer with Clamp version DN25 to 38/DN40 to 51
- 4 Thermometer with metal sealing system version, M12 × 1.5
- 5 Thermometer with metal sealing system version, G½"
- 6 Thermometer without process connection

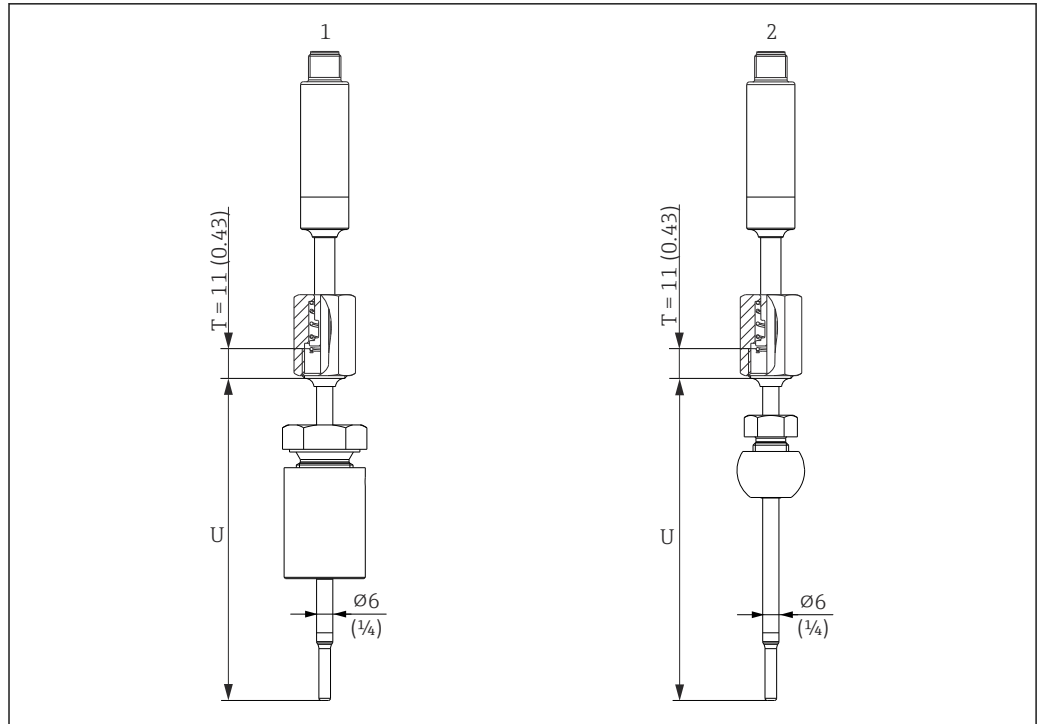

A0040086

- 1 Thermometer with compression fitting TK40 cylindrical, Elastosil sleeve, Ø30 mm, for welding in
- 2 Thermometer with compression fitting TK40 spherical, PEEK/316L sleeve, Ø25 mm, for welding in

**Thermowell version as T-piece or elbow piece**

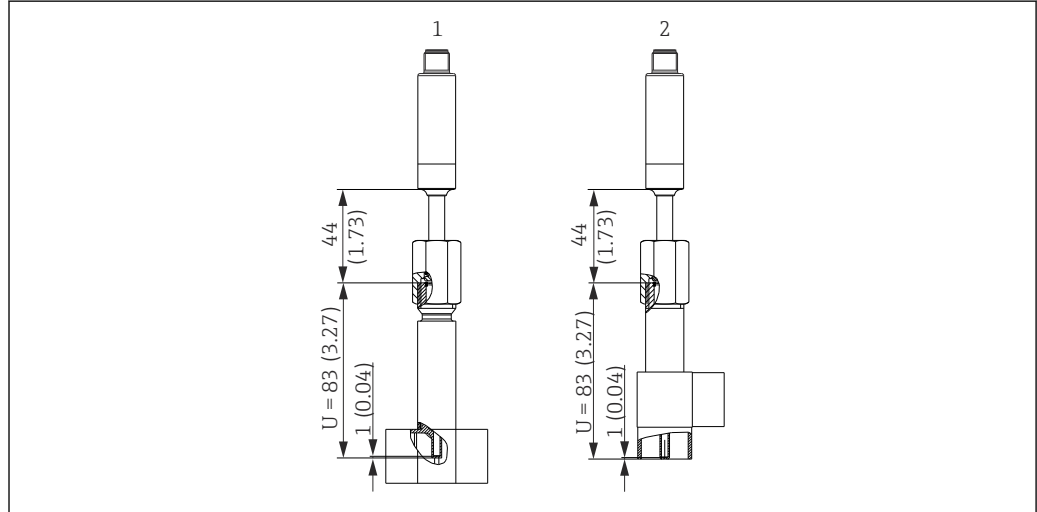

A0040028

- 1 Thermometer with tee thermowell
- 2 Thermometer with elbow thermowell

- Pipe sizes as per DIN 11865 series A (DIN), B (ISO) and C (ASME BPE)
- 3-A mark for nominal diameters ≥ DN25
- IP69 protection
- Material 1.4435+316L, delta ferrite content < 0.5%
- Temperature range -60 to +200 °C (-76 to +392 °F)
- Pressure range PN25 as per DIN11865



Due to the short immersion length U in the case of small pipe diameters, the use of iTHERM TipSens inserts is recommended.

### Possible combinations of the thermowell versions with the available process connections

Process connection and size	Direct contact, 6 mm (1/4 in)	Thermowell, 6 mm (1/4 in)
Without process connection (for installation with compression fitting)	☑	☑
Process adapter D45	☑	-
<b>Compression fitting</b>		
Thread G1/2"	☑	☑
Cylindrical Ø30 mm	☑	☑
Spherical Ø25 mm	☑	☑
<b>Thread</b>		
G1/2"	☑	-
G3/4"	☑	-
M14x1.5	☑	-
M18x1.5	☑	-
NPT1/2"	☑	-
<b>Weld-in adapter</b>		
Cylindrical Ø30 x 40 mm	-	☑
Cylindrical Ø12 x 40 mm	-	☑
Spherical-cylindrical Ø30 x 40 mm	-	☑
Spherical Ø25 mm (0.98 in)	-	☑
<b>Clamps according to ISO 2852</b>		
Microclamp/Tri-clamp DN18 (0.75 in)	☑	☑
DN12 - 21.3	☑	☑
DN25 - 38 (1 - 1.5 in)	☑	☑
DN40 - 51 (2 in)	☑	☑
<b>Milk pipe connection according to DIN 11851</b>		
DN25	☑	☑
DN32	☑	☑
DN40	☑	☑
DN50	☑	-
<b>Metal sealing system</b>		
M12x1	-	☑
G1/2"	☑	☑
<b>Thread according to ISO 228 for Liquiphant weld-in adapter</b>		
G3/4" for FTL20, FTL31, FTL33	☑	-
G3/4" for FTL50	☑	-
G1" for FTL50	☑	-
<b>APV Inline</b>		
DN50	☑	-
<b>Varivent®</b>		
Type B, Ø31 mm	☑	-
Type F, Ø50 mm	☑	-
Type N, Ø68 mm	☑	-

Process connection and size	Direct contact, 6 mm (¼ in)	Thermowell, 6 mm (¼ in)
<b>SMS 1147</b>		
DN25	☑	-
DN38	☑	-
DN51	☑	-

**Weight** 0.2 to 2.5 kg (0.44 to 5.5 lbs) for standard versions

**Material** The temperatures for continuous operation specified in the following table are only intended as reference values for use of the various materials in air and without any significant compressive load. The maximum operating temperatures can be reduced considerably in cases where abnormal conditions such as high mechanical load occur or in aggressive media.

Description	Short form	Recommended max. temperature for continuous use in air	Properties
AISI 316L (corresponds to 1.4404 or 1.4435)	X2CrNiMo17-13-2, X2CrNiMo18-14-3	650 °C (1202 °F) <sup>1)</sup>	<ul style="list-style-type: none"> <li>■ Austenitic, stainless steel</li> <li>■ High corrosion resistance in general</li> <li>■ Particularly high corrosion resistance in chlorine-based and acidic, non-oxidizing atmospheres through the addition of molybdenum (e.g. phosphoric and sulfuric acids, acetic and tartaric acids with a low concentration)</li> <li>■ Increased resistance to intergranular corrosion and pitting</li> </ul>
1.4435+316L, delta ferrite < 1% or < 0.5%	With regard to analytical limits, the specifications of both materials (1.4435 and 316L) are met simultaneously. In addition, the delta ferrite content of the parts in contact with the process is limited to <1% or <0.5%. ≤3% for weld seams (in accordance with Basel Standard II)		

1) Can be used to a limited extent up to 800 °C (1472 °F) for low compressive loads and in non-corrosive media. More information is available from the sales organization.

**Surface roughness** *Values for wetted surfaces:*

Standard surface, mechanically polished <sup>1)</sup>	$R_a \leq 0.76 \mu\text{m} (30 \mu\text{in})$
Mechanically polished <sup>1)</sup> , buffed <sup>2)</sup>	$R_a \leq 0.38 \mu\text{m} (15 \mu\text{in})$
Mechanically polished <sup>1)</sup> , buffed and electropolished	$R_a \leq 0.38 \mu\text{m} (15 \mu\text{in}) + \text{electropolished}$

1) Or equivalent treatment that guarantees  $R_a \text{ max}$

2) Not compliant with ASME BPE



Process connections

Compression fitting

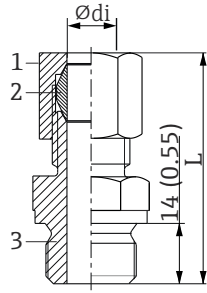
Type TK40	Version	Dimensions			Technical properties
		$\phi_{di}$	L	Across flats	
 <p>1 Nut 2 Clamping sleeve 3 Process connection</p> <p>A0039490</p>	G 1/2", ferrule material 316L	6 mm (0.24 in)	Approx. 47 mm (1.85 in)	G 1/2": 27 mm (1.06 in)	<ul style="list-style-type: none"> <li>■ <math>P_{max.} = 40</math> bar (104 psi) at <math>T = +200</math> °C (+392 °F) for 316L</li> <li>■ <math>P_{max.} = 25</math> bar (77 psi) at <math>T = +400</math> °C (+752 °F) for 316L</li> </ul> Tightening torque = 40 Nm

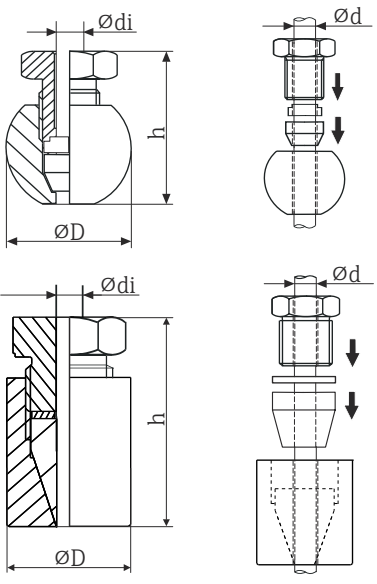
Type TK40 for weld-in	Version	Dimensions			Technical properties <sup>1)</sup>
		Spherical or cylindrical	$\phi_{di}$	$\phi_D$	
 <p>A0017582</p>	Spherical Material of sealing taper PEEK or 316L Thread G 1/4"	6.3 mm (0.25 in) <sup>2)</sup>	25 mm (0.98 in)	33 mm (1.3 in)	<ul style="list-style-type: none"> <li>■ <math>P_{max.} = 10</math> bar (145 psi)</li> <li>■ <math>T_{max.}</math> for PEEK sealing taper = +150 °C (+302 °F), tightening torque = 10 Nm</li> <li>■ <math>P_{max.} = 50</math> bar (725 psi)</li> <li>■ <math>T_{max.}</math> for 316L sealing taper = +200 °C (+392 °F), tightening torque = 25 Nm</li> <li>■ The TK40 PEEK sealing taper is EHEDG tested and 3-A marked</li> </ul>
	Cylindrical Sealing taper material Elastosil® Thread G 1/2"	6.2 mm (0.24 in) <sup>2)</sup>	30 mm (1.18 in)	57 mm (2.24 in)	<ul style="list-style-type: none"> <li>■ <math>P_{max.} = 10</math> bar (145 psi)</li> <li>■ <math>T_{max.}</math> for Elastosil® sealing taper = +150 °C (+302 °F), tightening torque = 5 Nm</li> <li>■ The TK40 Elastosil sealing taper is EHEDG tested and 3-A marked</li> </ul>

- 1) All the pressure specifications apply for cyclic temperature load
- 2) For insert or thermowell diameter  $\phi_d = 6$  mm (0.236 in).

Releasable process connection

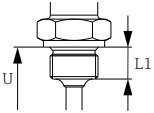
Type	Version G	Dimensions			Technical properties
		L1 thread length	A	Across flats	
 <p>A0040090</p>	G 1/4" ISO228	16 mm (0.63 in)	25.5 mm (1 in)	32	<ul style="list-style-type: none"> <li>■ <math>P_{max.} = 25</math> bar (362 psi) at max. 150 °C (302 °F)</li> <li>■ <math>P_{max.} = 40</math> bar (580 psi) at max. 100 °C (212 °F)</li> </ul>
	G 1/2" ISO228				
	M14x1.5	18.6 mm (0.73 in)	29.5 mm (1.16 in)	41	

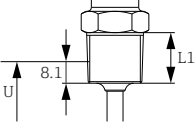
Type	Version G	Dimensions			Technical properties
		L1 thread length	A	Across flats	
	M18x1.5				
	½" NPT ANSI				

A0040091

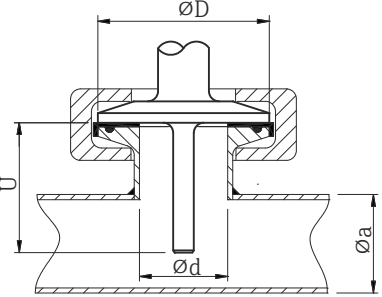
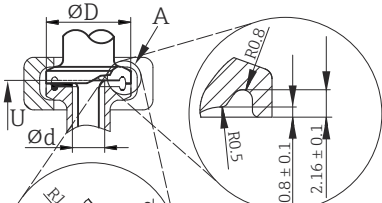
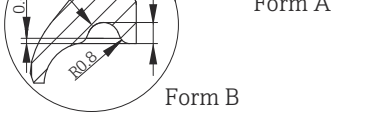
Type	Version	Dimensions		Technical properties
	Ød <sup>1)</sup>	ØD	Øa	
<p>Clamp according to ISO 2852</p>    <p>Form A</p> <p>Form B</p> <p>A Different seal geometries for Microclamp and Tri-clamp</p>	Microclamp <sup>2)</sup> DN8-18 (0.5"-0.75") <sup>3)</sup>	25 mm (0.98 in)	-	<ul style="list-style-type: none"> <li>■ P<sub>max.</sub> = 16 bar (232 psi), depends on clamp ring and suitable seal</li> <li>■ 3-A marked</li> </ul>
	Tri-clamp DN8-18 (0.5"-0.75") <sup>3)</sup>		-	
	DN12-21.3	34 mm (1.34 in)	16 to 25.3 mm (0.63 to 0.99 in)	<ul style="list-style-type: none"> <li>■ P<sub>max.</sub> = 16 bar (232 psi), depends on clamp ring and suitable seal</li> <li>■ 3-A marked and EHEDG certified (in connection with Combifit seal)</li> <li>■ ASME BPE compliance</li> </ul>
	DN25-38 (1"-1.5")	50.5 mm (1.99 in)	29 to 42.4 mm (1.14 to 1.67 in)	
	DN40-51 (2")	64 mm (2.52 in)	44.8 to 55.8 mm (1.76 to 2.2 in)	

A0009566

- 1) Pipes in accordance with ISO 2037 and BS 4825 Part 1
- 2) Microclamp (not in ISO 2852); no standard pipes
- 3) DN8 (0.5") only possible with thermowell diameter = 6 mm (¼ in)

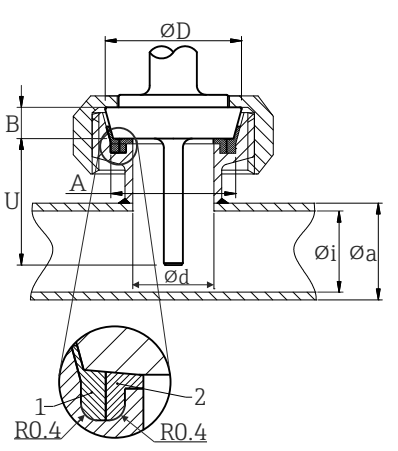
Type		Technical properties				
Milk pipe connection according to DIN 11851  <p>1 Centering ring 2 Sealing ring</p>		<ul style="list-style-type: none"> <li>3-A marked and EHEDG certified (only with EHEDG certified and self-centering sealing ring)</li> <li>ASME BPE compliance</li> </ul> <p style="text-align: right;">A0009561</p>				
Version <sup>1)</sup>	Dimensions					P <sub>max.</sub>
	ØD	A	B	Øi	Øa	
DN25	44 mm (1.73 in)	30 mm (1.18 in)	10 mm (0.39 in)	26 mm (1.02 in)	29 mm (1.14 in)	40 bar (580 psi)
DN32	50 mm (1.97 in)	36 mm (1.42 in)	10 mm (0.39 in)	32 mm (1.26 in)	35 mm (1.38 in)	40 bar (580 psi)
DN40	56 mm (2.2 in)	42 mm (1.65 in)	10 mm (0.39 in)	38 mm (1.5 in)	41 mm (1.61 in)	40 bar (580 psi)
DN50	68 mm (2.68 in)	54 mm (2.13 in)	11 mm (0.43 in)	50 mm (1.97 in)	53 mm (2.1 in)	25 bar (363 psi)

1) Pipes in accordance with DIN 11850

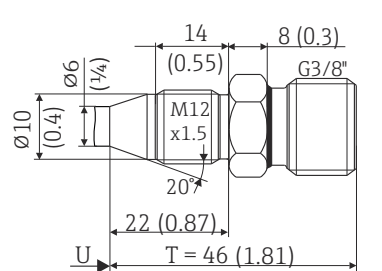
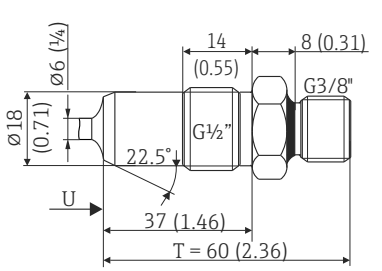
Type	Version	Technical properties
Metal sealing system		Thermowell diameter 6 mm (¼ in) P <sub>max.</sub> = 16 bar (232 psi)  Maximum torque = 10 Nm (7.38 lbf ft)
<b>M12x1.5</b>  <p style="text-align: right;">A0009574</p>	<b>G½"</b>  <p style="text-align: right;">A0020856</p>	
Thermowell diameter 6 mm (¼ in)		

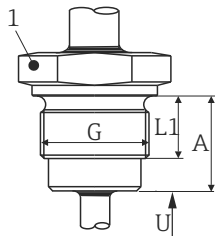
Type	Version G	Dimensions			Technical properties
		L1 thread length	A	1 (SW/AF)	
Thread according to ISO 228 (for Liquiphant weld-in adapter) 	G $\frac{3}{4}$ " for FTL20/31/33 adapter	16 mm (0.63 in)	25.5 mm (1 in)	32	<ul style="list-style-type: none"> <li>▪ P<sub>max.</sub> = 25 bar (362 psi) at max. 150 °C (302 °F)</li> <li>▪ P<sub>max.</sub> = 40 bar (580 psi) at max. 100 °C (212 °F)</li> <li>▪ 3-A marked and EHEDG tested</li> <li>▪ ASME BPE compliance</li> </ul>
	G $\frac{3}{4}$ " for FTL50 adapter				
	G1" for FTL50 adapter	18.6 mm (0.73 in)	29.5 mm (1.16 in)	41	

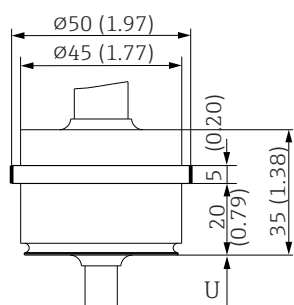
Type	Version	Technical properties
Process adapter 	D45	

For welding in

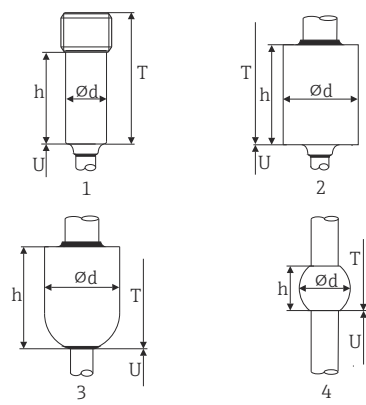
Type	Version	Dimensions	Technical properties
Weld-in adapter 	1: Cylindrical	$\phi d \times h = 12 \text{ mm (0.47 in)} \times 40 \text{ mm (1.57 in)}$ , T = 55 mm (2.17 in)	<ul style="list-style-type: none"> <li>▪ P<sub>max.</sub> depends on the weld-in process</li> <li>▪ 3-A marked and EHEDG certified</li> <li>▪ ASME BPE compliance</li> </ul>
	2: Cylindrical	$\phi d \times h = 30 \text{ mm (1.18 in)} \times 40 \text{ mm (1.57 in)}$	
	3: Spherical-cylindrical	$\phi d \times h = 30 \text{ mm (1.18 in)} \times 40 \text{ mm (1.57 in)}$	
	4: Spherical	$\phi d = 25 \text{ mm (0.98 in)}$ $h = 24 \text{ mm (0.94 in)}$	

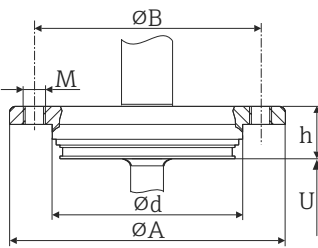
Type	Version	Dimensions					Technical properties
		$\phi d$	$\phi A$	$\phi B$	M	h	
APV Inline 	DN50	69 mm (2.72 in)	99.5 mm (3.92 in)	82 mm (3.23 in)	2xM8	19 mm (0.75 in)	<ul style="list-style-type: none"> <li>■ P<sub>max.</sub> = 25 bar (362 psi)</li> <li>■ 3-A marked and EHEDG certified</li> <li>■ ASME BPE compliance</li> </ul>

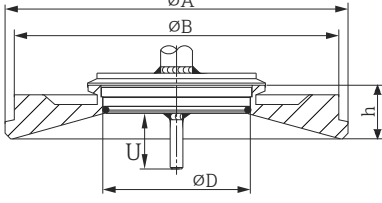
Type	Version	Dimensions				P <sub>max.</sub>	Technical properties
		$\phi D$	$\phi A$	$\phi B$	h		
Varivent® 	Type B	31 mm (1.22 in)	105 mm (4.13 in)	-	22 mm (0.87 in)	10 bar (145 psi)	<ul style="list-style-type: none"> <li>■ 3-A marked and EHEDG certified</li> <li>■ ASME BPE compliance</li> </ul>
	Type F	50 mm (1.97 in)	145 mm (5.71 in)	135 mm (5.31 in)	24 mm (0.95 in)		
	Type N	68 mm (2.67 in)	165 mm (6.5 in)	155 mm (6.1 in)	24.5 mm (0.96 in)		

**i** The VARINLINE® housing connection flange is suitable for weld-in into the conical or torispherical head in tanks or vessels with a small diameter ( $\leq 1.6$  m (5.25 ft)) and up to a wall thickness of 8 mm (0.31 in).

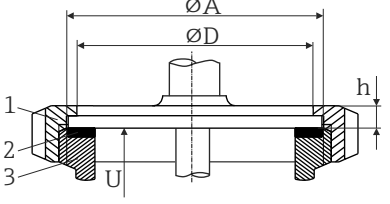
Type	Version	Dimensions			Technical properties
		$\phi D$	$\phi A$	h	
SMS 1147 	DN25	32 mm (1.26 in)	35.5 mm (1.4 in)	7 mm (0.28 in)	P <sub>max.</sub> = 6 bar (87 psi)
	DN38	48 mm (1.89 in)	55 mm (2.17 in)	8 mm (0.31 in)	
	DN51	60 mm (2.36 in)	65 mm (2.56 in)	9 mm (0.35 in)	

- 1 Cap-nut
- 2 Sealing ring
- 3 Counterpart connection

**i** The counterpart connection must fit the sealing ring and fix it in place.

T-piece, optimized (no welding, no dead legs)

Type	Version		Dimensions in mm (in)			Technical properties
			ØD	L	s <sup>1)</sup>	
<p>T-piece for weld-in as per DIN 11865 (series A, B and C)</p> <p>A0035898</p>	Series A	DN10 PN25	13 mm (0.51 in)	48 mm (1.89 in)	1.5 mm (0.06 in)	<ul style="list-style-type: none"> <li>■ P<sub>max.</sub> = 25 bar (362 psi)</li> <li>■ 3-A marked and EHEDG certified for ≥ DN25</li> <li>■ ASME BPE compliance for ≥ DN25</li> </ul>
		DN15 PN25	19 mm (0.75 in)			
		DN20 PN25	23 mm (0.91 in)			
		DN25 PN25	29 mm (1.14 in)			
		DN32 PN25	32 mm (1.26 in)			
	Series B	DN13.5 PN25	13.5 mm (0.53 in)		1.6 mm (0.063 in)	
		DN17.2 PN25	17.2 mm (0.68 in)			
		DN21.3 PN25	21.3 mm (0.84 in)			
		DN26.9 PN25	26.9 mm (1.06 in)		2 mm (0.08 in)	
		DN33.7 PN25	33.7 mm (1.33 in)			
	Series C <sup>2)</sup>	DN12.7 PN25 (½")	12.7 mm (0.5 in)		1.65 mm (0.065 in)	
		DN19.05 PN25 (¾")	19.05 mm (0.75 in)			
		DN25.4 PN25 (1")	25.4 mm (1 in)			
		DN38.1 PN25 (1½")	38.1 mm (1.5 in)			

1) Wall thickness  
 2) Pipe dimensions as per ASME BPE 2012

Elbow piece, optimized (no welding, no dead legs)

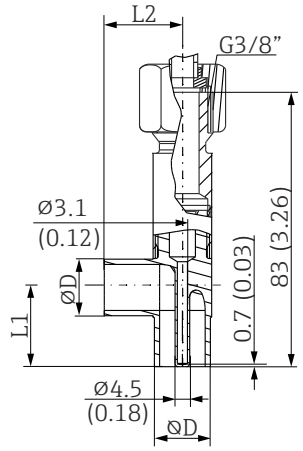
Type	Version		Dimensions				Technical properties
			ØD	L1	L2	s <sup>1)</sup>	
Corner piece for weld-in as per DIN 11865 (series A, B and C)  <small>A0035899</small>	Series A	DN10 PN25	13 mm (0.51 in)	24 mm (0.95 in)	1.5 mm (0.06 in)	<ul style="list-style-type: none"> <li>■ P<sub>max.</sub> = 25 bar (362 psi)</li> <li>■ 3-A marked and EHEDG certified for ≥ DN25</li> <li>■ ASME BPE compliance for ≥ DN25</li> </ul>	
		DN15 PN25	19 mm (0.75 in)	25 mm (0.98 in)			
		DN20 PN25	23 mm (0.91 in)	27 mm (1.06 in)			
		DN25 PN25	29 mm (1.14 in)	30 mm (1.18 in)			
		DN32 PN25	35 mm (1.38 in)	33 mm (1.3 in)			
	Series B	DN13.5 PN25	13.5 mm (0.53 in)	32 mm (1.26 in)	1.6 mm (0.063 in)		
		DN17.2 PN25	17.2 mm (0.68 in)	34 mm (1.34 in)			
		DN21.3 PN25	21.3 mm (0.84 in)	36 mm (1.41 in)			
		DN26.9 PN25	26.9 mm (1.06 in)	29 mm (1.14 in)			
		DN33.7 PN25	33.7 mm (1.33 in)	32 mm (1.26 in)	2.0 mm (0.08 in)		
	Series C	DN12.7 PN25 (½") <sup>2)</sup>	12.7 mm (0.5 in)	24 mm (0.95 in)	1.65 mm (0.065 in)		
		DN19.05 PN25 (¾")	19.05 mm (0.75 in)	25 mm (0.98 in)			
		DN25.4 PN25 (1")	25.4 mm (1 in)	28 mm (1.1 in)			
DN38.1 PN25 (1½")		38.1 mm (1.5 in)	35 mm (1.38 in)				

1) Wall thickness  
 2) Pipe dimensions as per ASME BPE 2012

Tip shape

**The thermal response time, the reduction of the flow cross-section and the mechanical load that occurs in the process are the criteria that matter when selecting the shape of the tip.**

Advantages of using reduced or tapered thermometer tips:

- A smaller tip shape has less impact on the flow characteristics of the pipe carrying the medium
- The flow characteristics are optimized
- Thermowell stability is increased

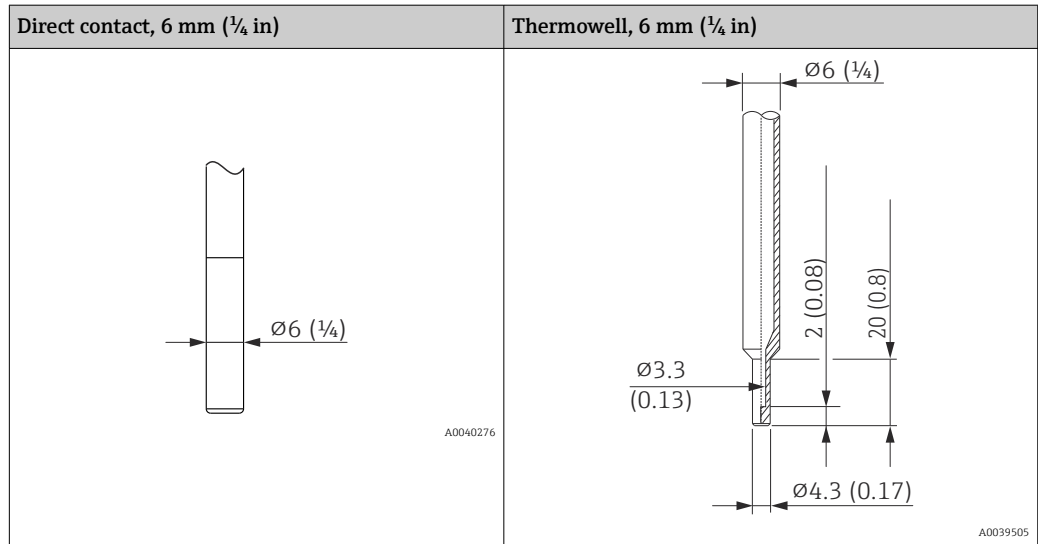

**i** It is possible to verify the mechanical loading capacity as a function of the installation and process conditions using the online TW Sizing Module for thermowells in the Endress+Hauser Applicator software →  30.

## 14.7 Certificates and approvals



Current certificates and approvals that are available for the product can be selected via the Product Configurator at [www.endress.com](http://www.endress.com):

1. Select the product using the filters and search field.
2. Open the product page.
3. Select **Configuration**.

MTBF

For the transmitter: 327 years, according to Siemens Standard SN29500

Hygiene standard

- EHEDG certification type EL - CLASS I. EHEDG-certified/tested process connections.  
→  49
- 3-A Authorization No. 1144, 3-A Sanitary Standard 74-07. Listed process connections.  
→  49
- ASME BPE, declaration of conformity can be ordered for options indicated
- FDA-compliant
- All surfaces in contact with the medium are free from materials derived from bovine animals or other livestock (ADI/TSE)

Materials in contact with food/product (FCM)

- The materials of the thermometer in contact with food/product (FCM) comply with the following European regulations:
- (EC) No. 1935/2004, Article 3, paragraph 1, Articles 5 and 17 on materials and articles intended to come into contact with food.
  - (EC) No. 2023/2006 on good manufacturing practice for materials and articles intended to come into contact with food.
  - (EU) No. 10/2011 on plastic materials and articles intended to come into contact with food.

CRN approval

The CRN approval is only available for certain thermowell versions. These versions are identified and displayed accordingly during the configuration of the device.



Detailed ordering information is available for your nearest sales organization [www.addresses.endress.com](http://www.addresses.endress.com) or in the Download Area under [www.endress.com](http://www.endress.com) :

1. Select the country
2. Select Downloads
3. In the search area: select Approvals/approval type
4. Enter the product code or device
5. Start the search

---

CRN approval	The CRN approval is only available for certain thermowell versions. Contact the supplier if necessary.
Surface roughness	Free from oil and grease for O <sub>2</sub> applications, optional
Material resistance	Material resistance - including resistance of housing - to the following Ecolab cleaning/ disinfection agents: <ul style="list-style-type: none"><li>■ P3-topax 66</li><li>■ P3-topactive 200</li><li>■ P3-topactive 500</li><li>■ P3-topactive OKTO</li><li>■ And demineralized water</li></ul>

---

## 15 Overview of the IO-Link operating menu

**i** The following tables list all the parameters that are contained in the operating menu. Depending on the parameter configuration, not all submenus and parameters are available in every device.

### **i** Operation concept

The IO-Link operating menu is based on an operation concept with different user roles.

User role	Meaning
Operator	The operator has read access to a limited selection of parameters that are required during operation.
Maintenance	The maintenance technician has read and write access to a limited selection of parameters that are required to service and maintain the device.
Specialist	The specialist (expert) has read and write access to all the parameters in the device.

<b>► Identification</b>		→ 60
	Application Specific Tag	→ 61
	Product Name	→ 61
	Product Text	→ 61
	Vendor Name	→ 62
	Serial Number	→ 62
	Firmware Version	→ 62
	Hardware Version	→ 63
	Order code	→ 63
	Extended order code	→ 63
	Device type	→ 64
<b>► Diagnosis</b>		→ 64
	<b>► Diagnostic list</b>	→ 64
	Actual diagnostics 1	→ 65
	Actual diagnostics 2	→ 65
	Actual diagnostics 3	→ 65
	<b>► Event logbook</b>	→ 65
	Previous diagnostics 1 ... 5	→ 66
	Timestamp 1 ... 5	→ 66
	<b>► Simulation</b>	→ 66
	Current output simulation	→ 66
	Value current output	→ 67

	Sensor simulation	→ 67
	Sensor simulation value	→ 68
	Switch output simulation	→ 68
▶ Sensor temperature		→ 69
	Sensor max value	→ 69
	Sensor min value	→ 70
	Reset sensor min/max values	→ 70
	Lower boundary operating time sensor	→ 70
	Lower extended operating time sensor	→ 71
	Standard operating time sensor	→ 71
	Upper extended operating time sensor	→ 71
	Upper boundary operating time sensor	→ 72
▶ Device temperature		→ 72
	Device temperature	→ 73
	Device temperature max	→ 73
	Device temperature min	→ 73
	Reset device temp. min/max values	→ 74
	Lower boundary operating time device	→ 74
	Lower extended operating time device	→ 74
	Standard operating time device	→ 75
	Upper extended operating time device	→ 75
	Upper boundary operating time device	→ 75
▶ Measuring data channel		→ 76
	MDC Descriptor.Lower limit	→ 76
	MDC Descriptor.Upper limit	→ 76
	MDC Descriptor.Unit code	→ 77
	MDC Descriptor.Scale	→ 77
▶ Parameter		→ 77
▶ Application		→ 78
	▶ Sensor	→ 78
	▶ Switch output	→ 79
	▶ Current output	→ 82

<b>► System</b>		→ 85
	Operating time	→ 85
	Alarm delay	→ 86
	Restore Factory Settings	→ 86
	DeviceAccessLocks.DataStorage	→ 86
	Activate parametrization lock	→ 87
	Deactivate parametrization lock	→ 87
<b>► Observation</b>		→ 87
	<b>► Process Data Input</b>	→ 87
	Process Data Input. Temperature value	→ 88
	Process Data Input. Sensor status	→ 88
	Process Data Input. Switch output	→ 88

## 15.1 Description of device parameters

### 15.1.1 Identification

Navigation  Identification

<b>► Identification</b>		
	Application Specific Tag	→ 61
	Product Name	→ 61
	Product Text	→ 61
	Vendor Name	→ 62
	Serial Number	→ 62
	Firmware Version	→ 62
	Hardware Version	→ 63
	Order code	→ 63
	Extended order code	→ 63
	Device type	→ 64

---

**Application Specific Tag**

---

<b>Navigation</b>	 Identification → Application Specific Tag
<b>Description</b>	Use this function to enter a unique name for the measuring point so it can be identified quickly within the plant.
<b>User entry</b>	Max. 32 alphanumeric characters
<b>Factory setting</b>	As per order specifications
<b>Additional information</b>	<i>User role</i> <ul style="list-style-type: none"> <li>■ Operator</li> <li>■ Maintenance</li> <li>■ Specialist</li> </ul>

---

**Product Name**

---



<b>Navigation</b>	 Identification → Product Name
<b>Description</b>	Displays the product name
<b>User interface</b>	iTHERM CompactLine TM311
<b>Additional information</b>	<i>User role</i> <ul style="list-style-type: none"> <li>■ Operator</li> <li>■ Maintenance</li> <li>■ Specialist</li> </ul>





---

**Product Text**

---



<b>Navigation</b>	 Identification → Product Text
<b>Description</b>	Displays the product text
<b>User interface</b>	Compact thermometer
<b>Additional information</b>	<i>User role</i> <ul style="list-style-type: none"> <li>■ Operator</li> <li>■ Maintenance</li> <li>■ Specialist</li> </ul>

Vendor Name 	
<b>Navigation</b>	 Identification → Vendor Name
<b>Description</b>	Displays the manufacturer name
<b>User interface</b>	Endress+Hauser
<b>Additional information</b>	<i>User role</i> <ul style="list-style-type: none"> <li>■ Operator</li> <li>■ Maintenance</li> <li>■ Specialist</li> </ul>
Serial Number 	
<b>Navigation</b>	 Identification → Serial Number
<b>Description</b>	Displays the serial number of the device. It can also be found on the nameplate. To obtain specific information on the measuring device using the Device Viewer: <a href="http://www.endress.com/deviceviewer">www.endress.com/deviceviewer</a>
<b>User interface</b>	Character string comprising numbers, letters and special characters
<b>Additional information</b>	<i>User role</i> <ul style="list-style-type: none"> <li>■ Operator</li> <li>■ Maintenance</li> <li>■ Specialist</li> </ul>
Firmware Version	
<b>Navigation</b>	 Identification → Firmware Version
<b>Description</b>	Displays the firmware version
<b>User interface</b>	Character string comprising numbers, letters and special characters
<b>Additional information</b>	<i>User role</i> <ul style="list-style-type: none"> <li>■ Operator</li> <li>■ Maintenance</li> <li>■ Specialist</li> </ul>

---

**Hardware Version**



---

<b>Navigation</b>	 Identification → Hardware Version
<b>Description</b>	Displays the hardware version
<b>User interface</b>	Character string comprising numbers, letters and special characters
<b>Additional information</b>	<i>User role</i> <ul style="list-style-type: none"> <li>■ Operator</li> <li>■ Maintenance</li> <li>■ Specialist</li> </ul>

---

**Order code**



---

<b>Navigation</b>	 Identification → Order code
<b>Description</b>	Displays the order code
<b>User interface</b>	Character string comprising numbers, letters and special characters
<b>Additional information</b>	<i>User role</i> <ul style="list-style-type: none"> <li>■ Operator</li> <li>■ Maintenance</li> <li>■ Specialist</li> </ul>

---

**Extended order code**

---







<b>Navigation</b>	 Identification → Extended order code
<b>Description</b>	<p>Displays the extended order code.</p> <p>The extended order code indicates the attributes for all the device features in the product structure.</p>
<b>User interface</b>	Character string comprising numbers, letters and special characters
<b>Additional information</b>	<i>User role</i> <ul style="list-style-type: none"> <li>■ Operator</li> <li>■ Maintenance</li> <li>■ Specialist</li> </ul>

**Device type**

<b>Navigation</b>	 Identification → Device type
<b>Description</b>	Displays the device type
<b>User interface</b>	37 887 (0x93FF)
<b>Additional information</b>	<i>User role</i> <ul style="list-style-type: none"> <li>■ Operator</li> <li>■ Maintenance</li> <li>■ Specialist</li> </ul>



**15.1.2 Diagnosis**

*Navigation*  Diagnosis

<b>▶ Diagnosis</b>		
	<b>▶ Diagnostic list</b>	→  64
	<b>▶ Event logbook</b>	→  65
	<b>▶ Simulation</b>	→  66
	<b>▶ Sensor temperature</b>	→  69
	<b>▶ Device temperature</b>	→  72
	<b>▶ Measuring data channel</b>	→  76

**Diagnostic list**

*Navigation*  Diagnosis → Diagnostic list

<b>▶ Diagnostic list</b>		
	Actual diagnostics 1	→  65
	Actual diagnostics 2	→  65
	Actual diagnostics 3	→  65



**Actual diagnostics 1**



**Navigation**

Diagnosis → Diagnostic list → Actual diagnostics 1

**Description**

Displays the diagnostic message with the highest priority that is currently active.

**Additional information**

*User role*

- Operator
- Maintenance
- Specialist

**Actual diagnostics 2**



**Navigation**

Diagnosis → Diagnostic list → Actual diagnostics 2

**Description**

Displays the diagnostic message with the second-highest priority that is currently active.

**Additional information**

*User role*

- Operator
- Maintenance
- Specialist

**Actual diagnostics 3**



**Navigation**

Diagnosis → Diagnostic list → Actual diagnostics 3

**Description**

Displays the diagnostic message with the third-highest priority that is currently active.

**Additional information**

*User role*

- Operator
- Maintenance
- Specialist

**Event logbook**

*Navigation* Diagnosis → Event logbook

▶ Event logbook

Previous diagnostics 1 ... 5

→ 66

Timestamp 1 ... 5

→ 66

**Previous diagnostics 1 ... 5**



<b>Navigation</b>	Diagnosis → Event logbook → Previous diagnostics 1 ... 5
<b>Description</b>	Displays the diagnostic messages that occurred in the past (in chronological order).
<b>Additional information</b>	<i>User role</i> Specialist

**Timestamp 1 ... 5**



<b>Navigation</b>	Diagnosis → Event logbook → Timestamp 1 ... 5
<b>Description</b>	Displays the time of the last diagnostic message. The time comes from the operating time counter.
<b>Additional information</b>	<i>User role</i> Specialist

**Simulation**

*Navigation*      Diagnosis → Simulation

▶ Simulation

Current output simulation	→  66
Value current output	→  67
Sensor simulation	→  67
Sensor simulation value	→  68
Switch output simulation	→  68

**Current output simulation**

<b>Navigation</b>	Diagnosis → Simulation → Current output simulation
<b>Description</b>	Use this function to switch simulation of the current output on and off.
<b>Selection</b>	<ul style="list-style-type: none"> <li>■ Off</li> <li>■ On</li> </ul>

**Factory setting** Off

**Additional information** *Description*

 If a simulation is active, a warning to this effect is communicated via IO-Link (C491 - Simulation output). The simulation must be ended actively via the operating menu. If the device is disconnected from the power supply during the simulation and then power is resupplied afterwards, the simulation mode remains active. If the device is disconnected from the power supply a second time and then power is resupplied afterwards, the device resumes operation in the normal mode.

*User role*

- Operator
- Maintenance
- Specialist

---

## Value current output

---

**Navigation**  Diagnosis → Simulation → Value current output

**Description** Use this function to enter a current value for the simulation. In this way, users can verify the correct adjustment of the current output and the correct function of downstream switching units.

**User entry** 3.58 to 23 mA

**Additional information** *User role*

- Operator
- Maintenance
- Specialist

---

## Sensor simulation

---

**Navigation**  Diagnosis → Simulation → Sensor simulation

**Description** Use this function to enable the simulation of the process variable.

**Selection**

- Off
- On

**Factory setting** Off

**Additional information**

*Description*

 If a simulation is active, a warning to this effect is communicated via IO-Link (C485 - Simulation process variable). The simulation must be ended actively via the operating menu. If the device is disconnected from the power supply during the simulation and then power is resupplied afterwards, the simulation mode remains active. If the device is disconnected from the power supply a second time and then power is resupplied afterwards, the device resumes operation in the normal mode.

*User role*

- Operator
- Maintenance
- Specialist

**Sensor simulation value**

**Navigation**

 Diagnosis → Simulation → Sensor simulation value

**Description**

Use this function to enter a simulation value for the process variable. Subsequent measured value processing and the signal output use this simulation value. In this way, users can verify whether the measuring device has been configured correctly.

**User entry**

-50 to +200 °C

**Additional information**

*User role*

- Operator
- Maintenance
- Specialist

**Switch output simulation**

**Navigation**

 Diagnosis → Simulation → Switch output simulation

**Description**

Use this function to enable and configure the simulation of the switch output.

**Selection**

- Disabled
- Off
- On

**Factory setting**

Disabled

**Additional information**

*Description*









 If a simulation is active, a warning to this effect is communicated via IO-Link (C494 - Simulation switch output). The simulation must be ended actively via the operating menu. If the device is disconnected from the power supply during the simulation and then power is resupplied afterwards, the simulation mode remains active. If the device is disconnected from the power supply a second time and then power is resupplied afterwards, the device resumes operation in the normal mode.

*User role*

- Operator
- Maintenance
- Specialist

**Sensor temperature**

*Navigation*  Diagnosis → Sensor temperature

▶ Sensor temperature	
Sensor max value	→  69
Sensor min value	→  70
Reset sensor min/max values	→  70
Lower boundary operating time sensor	→  70
Lower extended operating time sensor	→  71
Standard operating time sensor	→  71
Upper extended operating time sensor	→  71
Upper boundary operating time sensor	→  72

**Sensor max value**

**Navigation**

 Diagnosis → Sensor temperature → Sensor max value

**Description**

Displays the maximum temperature measured in the past at the sensor input (maximum indicator).

**Additional information**

*User role*

- Operator
- Maintenance
- Specialist

**Sensor min value**

<b>Navigation</b>	☰ Diagnosis → Sensor temperature → Sensor min value
<b>Description</b>	Displays the minimum temperature measured in the past at the sensor input (minimum indicator).
<b>Additional information</b>	<i>User role</i> <ul style="list-style-type: none"> <li>■ Operator</li> <li>■ Maintenance</li> <li>■ Specialist</li> </ul>

**Reset sensor min/max values**



<b>Navigation</b>	☰ Diagnosis → Sensor temperature → Reset sensor min/max values
<b>Description</b>	Resets the lowest and highest temperature value measured at the sensor (reset the minimum/maximum indicators for the sensor temperature).
<b>Additional information</b>	<i>User role</i> <ul style="list-style-type: none"> <li>■ Operator</li> <li>■ Maintenance</li> <li>■ Specialist</li> </ul>

**Lower boundary operating time sensor**

<b>Navigation</b>	☰ Diagnosis → Sensor temperature → Lower boundary operating time sensor
<b>Description</b>	Displays the operating time of the sensor in the lower process temperature boundary zone (Lower boundary).

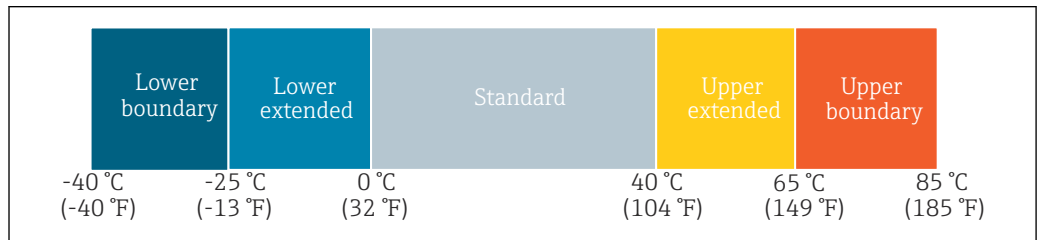

A0040333

<b>Additional information</b>	<i>User role</i> Specialist
-------------------------------	--------------------------------

**Lower extended operating time sensor**

**Navigation**

☰ Diagnosis → Sensor temperature → Lower extended operating time sensor

**Description**

Displays the operating time of the sensor in the lower process temperature range (Lower extended).

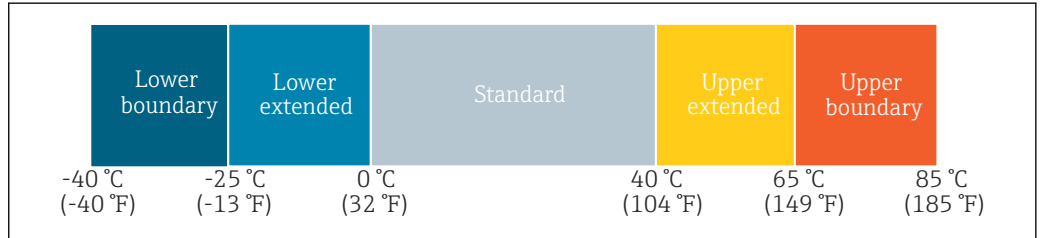

A0040333

**Additional information**

*User role*  
Specialist

**Standard operating time sensor**



**Navigation**

☰ Diagnosis → Sensor temperature → Standard operating time sensor

**Description**

Displays the operating time of the sensor in the normal process temperature range (Standard).

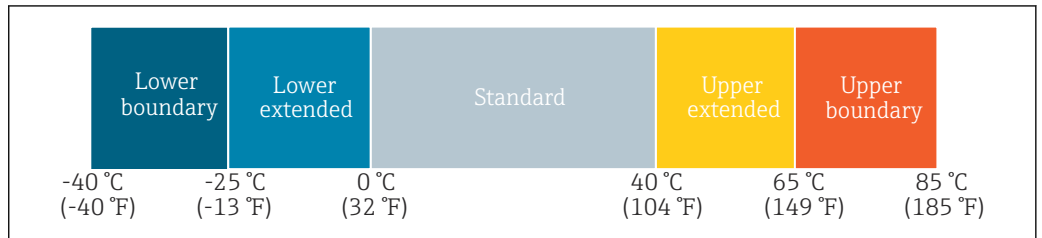

A0040333

**Additional information**

*User role*  
Specialist

**Upper extended operating time sensor**



**Navigation**

☰ Diagnosis → Sensor temperature → Upper extended operating time sensor

**Description**

Displays the operating time of the sensor in the upper process temperature range (Upper extended).

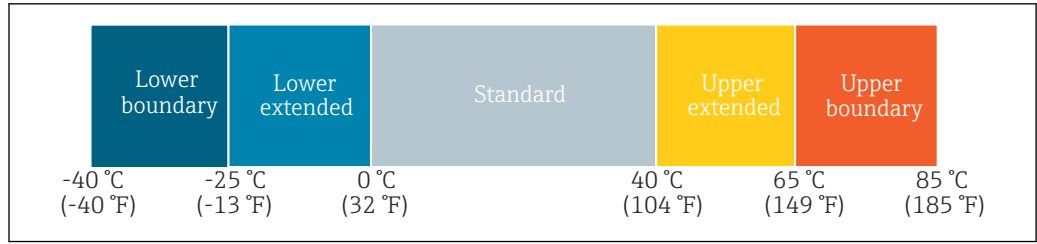

A0040333

**Additional information** *User role*  
Specialist

**Upper boundary operating time sensor**



**Navigation** Diagnosis → Sensor temperature → Upper boundary operating time sensor

**Description** Displays the operating time of the sensor in the upper process temperature boundary zone (Upper boundary).

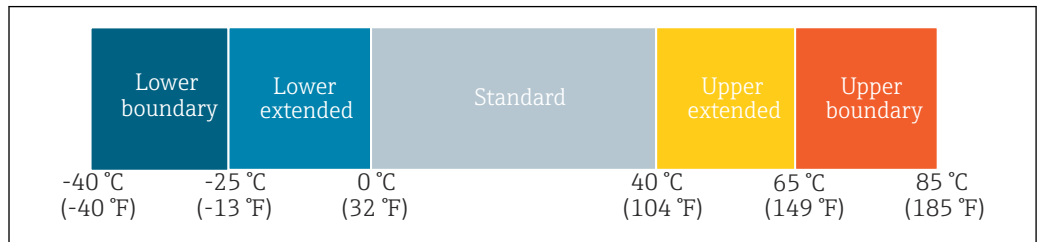

A0040333

**Additional information** *User role*  
Specialist



**Device temperature**

*Navigation* Diagnosis → Device temperature

▶ Device temperature

Device temperature	→  73
Device temperature max	→  73
Device temperature min	→  73
Reset device temp. min/max values	→  74
Lower boundary operating time device	→  74
Lower extended operating time device	→  74
Standard operating time device	→  75



	Upper extended operating time device	→  75
	Upper boundary operating time device	→  75

---

## Device temperature

---

**Navigation**  Diagnosis → Device temperature → Device temperature

**Description** Displays the current device temperature (electronics).

**Additional information** *User role*

- Operator
- Maintenance
- Specialist

---

## Device temperature max

---

**Navigation**  Diagnosis → Device temperature → Device temperature max

**Description** Displays the maximum device temperature measured in the past (maximum indicator).

**Additional information** *User role*

- Operator
- Maintenance
- Specialist

---

## Device temperature min

---

**Navigation**  Diagnosis → Device temperature → Device temperature min

**Description** Displays the minimum device temperature measured in the past (minimum indicator).

**Additional information** *User role*

- Operator
- Maintenance
- Specialist

**Reset device temp. min/max values**

**Navigation**  Diagnosis → Device temperature → Reset device temp. min/max values

**Description** Resets the lowest and highest device temperature that has been measured (reset the minimum/maximum indicators for the device temperature).

**Additional information** *User role*

- Operator
- Maintenance
- Specialist

**Lower boundary operating time device**



**Navigation**  Diagnosis → Device temperature → Lower boundary operating time device

**Description** Displays the operating time of the device in the lower ambient temperature boundary zone (Lower boundary).

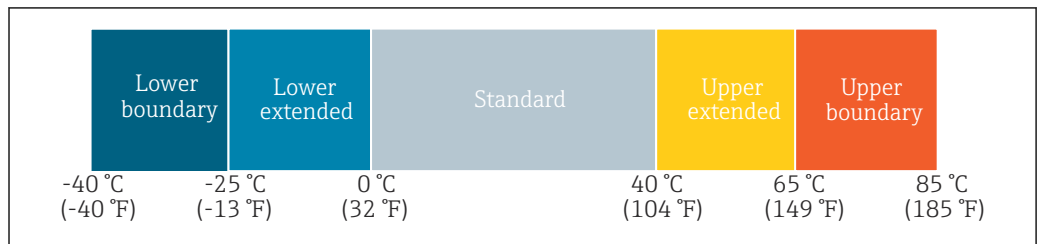

A0040333

**Additional information** *User role*  
Specialist

**Lower extended operating time device**



**Navigation**  Diagnosis → Device temperature → Lower extended operating time device

**Description** Displays the operating time of the device in the lower ambient temperature range (Lower extended).

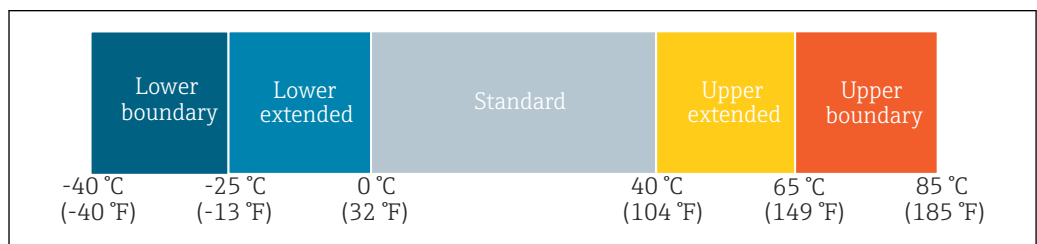

A0040333

**Additional information** *User role*  
Specialist

**Standard operating time device**



**Navigation**

☰ Diagnosis → Device temperature → Standard operating time device

**Description**

Displays the operating time of the device in the normal ambient temperature range (Standard).

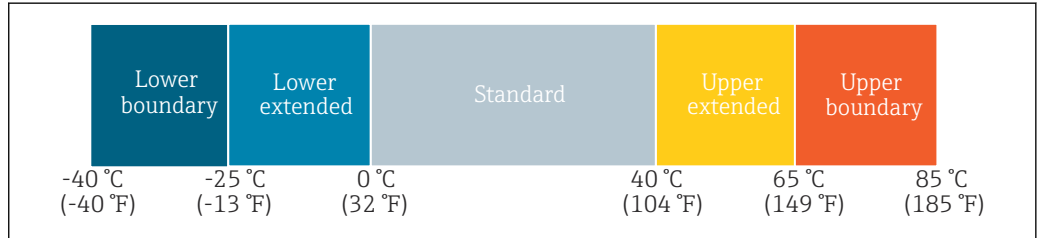

A0040333

**Additional information**

*User role*  
Specialist

**Upper extended operating time device**



**Navigation**

☰ Diagnosis → Device temperature → Upper extended operating time device

**Description**

Displays the operating time of the device in the upper ambient temperature range (Upper extended).

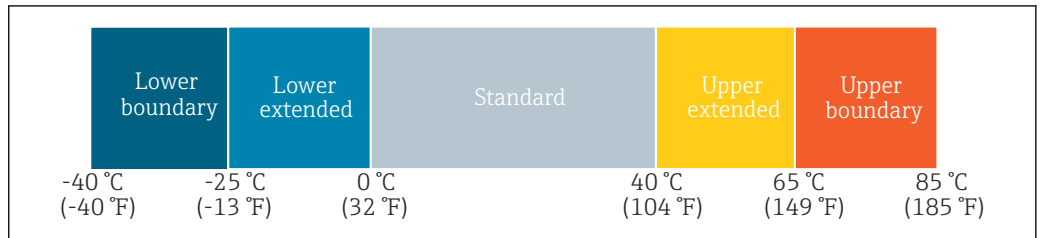

A0040333

**Additional information**

*User role*  
Specialist

**Upper boundary operating time device**



**Navigation**

☰ Diagnosis → Device temperature → Upper boundary operating time device

**Description**

Displays the operating time of the device in the upper ambient temperature boundary zone (Upper boundary).

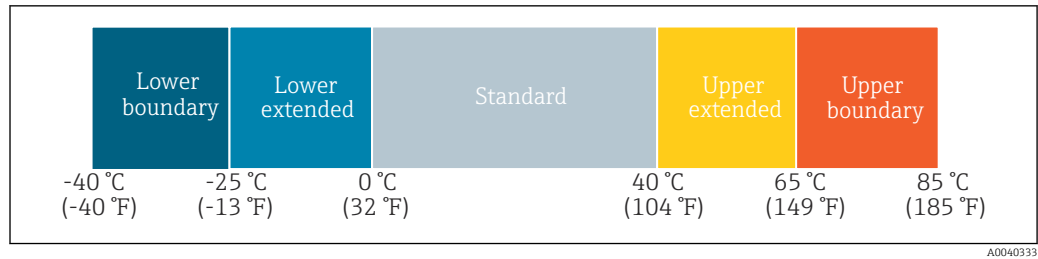

**Additional information** *User role*  
Specialist

**Measuring data channel**

*Navigation* Diagnosis → Measuring data channel

▶ Measuring data channel

MDC Descriptor.Lower limit	→  76
MDC Descriptor.Upper limit	→  76
MDC Descriptor.Unit code	→  77
MDC Descriptor.Scale	→  77

**MDC Descriptor.Lower limit**

**Navigation** Diagnosis → Measuring data channel → MDC Descriptor.Lower limit

**Description** Displays the lower value of the measuring range.  
According to Smart Sensor Profile 2<sup>nd</sup> Edition.

**Additional information** *User role*

- Operator
- Maintenance
- Specialist

**MDC Descriptor.Upper limit**

**Navigation** Diagnosis → Measuring data channel → MDC Descriptor.Upper limit

**Description** Displays the upper value of the measuring range.  
According to Smart Sensor Profile 2<sup>nd</sup> Edition.

**Additional information** *User role*

- Operator
- Maintenance
- Specialist

**MDC Descriptor.Unit code** 

**Navigation**  Diagnosis → Measuring data channel → MDC Descriptor.Unit code

**Description** Displays the unit code for the unit according to IO-Link.  
According to Smart Sensor Profile 2<sup>nd</sup> Edition.

**Additional information** *User role*

- Operator
- Maintenance
- Specialist

**MDC Descriptor.Scale** 

**Navigation**  Diagnosis → Measuring data channel → MDC Descriptor.Scale



**Description** Displays the scaling of the measured value ( $10^{\text{scale}}$ ).  
According to Smart Sensor Profile 2<sup>nd</sup> Edition.

**Additional information** *User role*

- Operator
- Maintenance
- Specialist



### 15.1.3 Parameters

*Navigation*  Parameter

▶ Parameter	
▶ Application	→  78
▶ System	→  85



### Application

Navigation  Parameter → Application

▶ Application		
	▶ Sensor	→  78
	▶ Switch output	→  85
	▶ Current output	→  85

### Sensor

Navigation  Parameter → Application → Sensor

▶ Sensor		
	Unit	→  78
	Damping	→  78
	Sensor offset	→  79

---

### Unit

<b>Navigation</b>	 Parameter → Application → Sensor → Unit
<b>Description</b>	Use this function to select the engineering unit for all the measured values and parameters.
<b>Selection</b>	<ul style="list-style-type: none"> <li>■ °C</li> <li>■ °F</li> <li>■ K</li> </ul>
<b>Factory setting</b>	°C
<b>Additional information</b>	<i>User role</i> <ul style="list-style-type: none"> <li>■ Operator</li> <li>■ Maintenance</li> <li>■ Specialist</li> </ul>

---

### Damping

<b>Navigation</b>	 Parameter → Application → Sensor → Damping
<b>Description</b>	Use this function to enter the time constant for measured value damping.

<b>User entry</b>	0 to 120 s
<b>Factory setting</b>	0 s
<b>Additional information</b>	<i>User role</i> <ul style="list-style-type: none"> <li>■ Operator</li> <li>■ Maintenance</li> <li>■ Specialist</li> </ul>





**Sensor offset**

<b>Navigation</b>	 Parameter → Application → Sensor → Sensor offset
<b>Description</b>	Use this function to enter the zero point correction (offset) of the sensor measured value. The value indicated is added to the measured value.
<b>User entry</b>	-10 to +10 °C (14 to 50 °F)
<b>Factory setting</b>	0 °C
<b>Additional information</b>	<i>User role</i> <ul style="list-style-type: none"> <li>■ Operator</li> <li>■ Maintenance</li> <li>■ Specialist</li> </ul>

*Switch output*

*Navigation*  Parameter → Application → Switch output

▶ Switch output

Operating mode	→  80
Switch point value	→  81
Switchback point value	→  81
Switch delay	→  82
Switchback delay	→  82

**Operating mode**

**Navigation**  Parameter → Application → Switch output → Operating mode

**Description** Use this function to select the switch output.

- Selection**
- Hysteresis normally open
  - Hysteresis normally closed
  - Window normally open
  - Window normally closed
  - Off

**Factory setting** Hysteresis normally open (or as per order specifications)

- Additional information** *Selection*
- Hysteresis normally open  
The switch output is specified as a normally open (NO) contact with hysteresis properties (using SP and RSP).
  - Hysteresis normally closed  
The switch output is specified as a normally closed (NC) contact with hysteresis properties (using SP and RSP).
  - Window normally open  
The switch output is specified as a normally open (NO) contact with window properties (using SP and RSP).
  - Window normally closed  
The switch output is specified as a normally closed (NC) contact with window properties (using SP and RSP).
  - Off  
The switch function is not active.

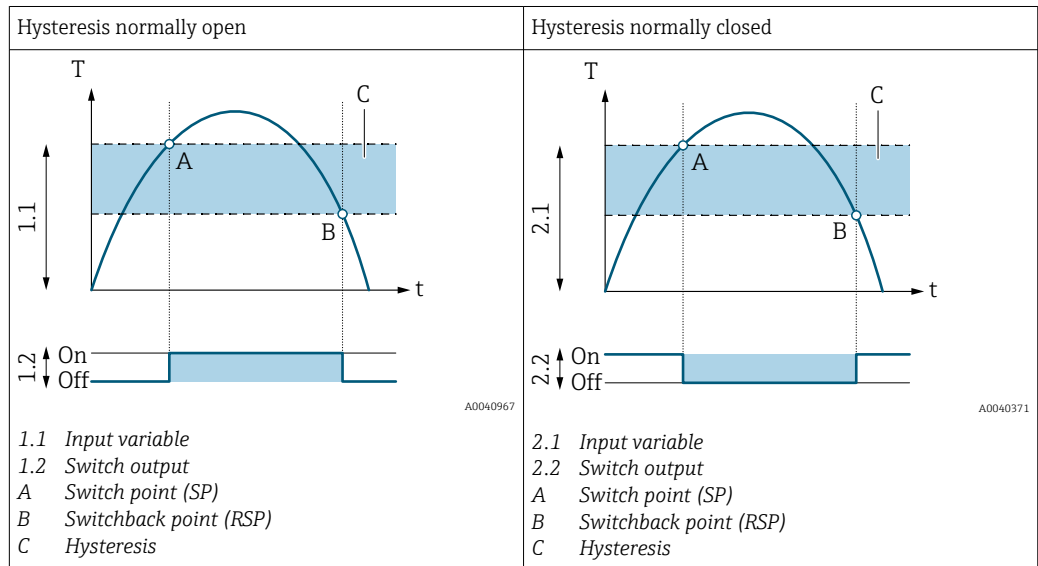



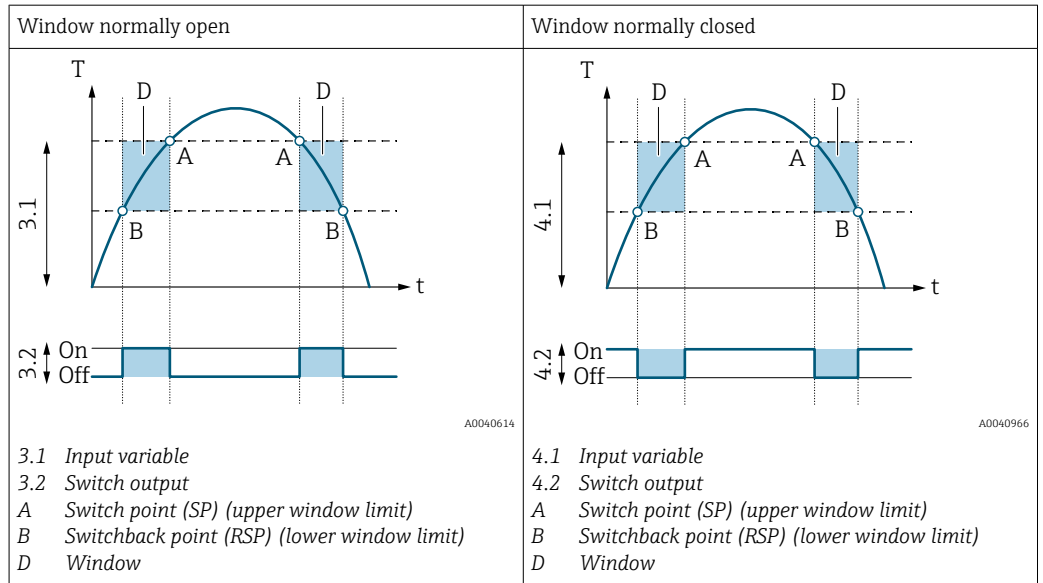

User role

- Operator
- Maintenance
- Specialist

Switch point value

<b>Navigation</b>	Parameter → Application → Switch output → Switch point value
<b>Description</b>	Use this function to enter the switch point (SP) for the hysteresis/upper value for the window function. The value entered must be greater than the switchback point (RSP).
<b>User entry</b>	Signed floating-point number
<b>Factory setting</b>	100 °C
<b>Additional information</b>	<p>User role</p> <ul style="list-style-type: none"> <li>■ Operator</li> <li>■ Maintenance</li> <li>■ Specialist</li> </ul>

Switchback point value

<b>Navigation</b>	Parameter → Application → Switch output → Switchback point value
<b>Description</b>	Use this function to enter the switchback point (RSP) for the hysteresis/lower switch point for the window function. The value entered must be smaller than the switch point (SP).

**Additional information** *User role*

- Operator
- Maintenance
- Specialist

**Switch delay**

**Navigation**  Parameter → Application → Switch output → Switch delay

**Description** Use this function to enter a delay time to prevent constant switching at values around the switch point (SP). If the measured value leaves the switching range during the delay time, the delay time starts again.

**User entry** 0 to 99 s

**Factory setting** 0 s

**Additional information** *User role*

- Operator
- Maintenance
- Specialist

**Switchback delay**

**Navigation**  Parameter → Application → Switch output → Switchback delay

**Description** Use this function to enter a delay time to prevent constant switching at values around the switchback point (RSP). If the measured value leaves the switching range during the delay time, the delay time starts again.

**User entry** 0 to 99 s

**Factory setting** 0 s







**Additional information** *User role*

- Operator
- Maintenance
- Specialist

*Current output*

*Navigation*  Parameter → Application → Current output



▶ Current output

	4 mA value	→  83
	20 mA value	→  83
	Current trimming 4 mA	→  84
	Current trimming 20 mA	→  84
	Failure mode	→  84
	Failure current	→  85

---

### 4 mA value



---

<b>Navigation</b>	 Parameter → Application → Current output → 4 mA value
<b>Description</b>	Use this function to enter the temperature value that is to correspond to the 4 mA value. It is possible to invert the current output by changing the assignment of the start/end of the measuring range.  The span between the 4 mA value and the 20 mA value must be at least 10 K.
<b>User entry</b>	-50 000 to +50 000 °C (-89 968 to +90 032 °F)
<b>Factory setting</b>	0 °C
<b>Additional information</b>	<i>User role</i> <ul style="list-style-type: none"> <li>■ Operator</li> <li>■ Maintenance</li> <li>■ Specialist</li> </ul>

---

### 20 mA value

---

<b>Navigation</b>	 Parameter → Application → Current output → 20 mA value
<b>Description</b>	Use this function to enter the temperature value that is to correspond to the 20 mA value. It is possible to invert the current output by changing the assignment of the start/end of the measuring range.  The span between the 4 mA value and the 20 mA value must be at least 10 K.
<b>User entry</b>	-50 000 to +50 000 °C (-89 968 to +90 032 °F)
<b>Factory setting</b>	150 °C
<b>Additional information</b>	<i>User role</i> <ul style="list-style-type: none"> <li>■ Operator</li> <li>■ Maintenance</li> <li>■ Specialist</li> </ul>

---

**Current trimming 4 mA**



---

<b>Navigation</b>	 Parameter → Application → Current output → Current trimming 4 mA
<b>Description</b>	Use this function to enter the correction value for the current output at the start of the measuring range at 4 mA.
<b>User entry</b>	3.85 to 4.15 mA
<b>Factory setting</b>	4.00 mA
<b>Additional information</b>	<i>User role</i> <ul style="list-style-type: none"> <li>■ Operator</li> <li>■ Maintenance</li> <li>■ Specialist</li> </ul>

---

**Current trimming 20 mA**



---

<b>Navigation</b>	 Parameter → Application → Current output → Current trimming 20 mA
<b>Description</b>	Use this function to enter the correction value for the current output at the end of the measuring range at 20 mA.
<b>User entry</b>	19.85 to 20.15 mA
<b>Factory setting</b>	20.00 mA
<b>Additional information</b>	<i>User role</i> <ul style="list-style-type: none"> <li>■ Operator</li> <li>■ Maintenance</li> <li>■ Specialist</li> </ul>

---

**Failure mode**



---

<b>Navigation</b>	 Parameter → Application → Current output → Failure mode
<b>Description</b>	Use this function to select the signal on alarm level of the current output in the event of an error.
<b>Selection</b>	<ul style="list-style-type: none"> <li>■ 0 (Low alarm)</li> <li>■ 2 (High alarm)</li> </ul>
<b>Factory setting</b>	0
<b>Additional information</b>	<i>User role</i> <ul style="list-style-type: none"> <li>■ Operator</li> <li>■ Maintenance</li> <li>■ Specialist</li> </ul>







---

**Failure current**

---

<b>Navigation</b>	 Parameter → Application → Current output → Failure current
<b>Description</b>	Use this function to enter the current value for a high alarm that the current output adopts in an alarm condition.
<b>User entry</b>	21.50 to 23.00 mA
<b>Factory setting</b>	22.5 mA
<b>Additional information</b>	<i>User role</i> <ul style="list-style-type: none"> <li>■ Operator</li> <li>■ Maintenance</li> <li>■ Specialist</li> </ul>

**System**
*Navigation*  Parameter → System

▶ System		
	Operating time	→  85
	Alarm delay	→  86
	Restore Factory Settings	→  86
	DeviceAccessLocks.DataStorage	→  86
	Activate parametrization lock	→  87
	Deactivate parametrization lock	→  87

---

**Operating time**

---



<b>Navigation</b>	 Parameter → System → Operating time
<b>Description</b>	Displays the length of time in hours (h) that the device has been in operation up until now.
<b>Additional information</b>	<i>User role</i> <ul style="list-style-type: none"> <li>■ Operator</li> <li>■ Maintenance</li> <li>■ Specialist</li> </ul>

---

**Alarm delay**



---

<b>Navigation</b>	 Parameter → System → Alarm delay
<b>Description</b>	Use this function to enter the delay time during which a diagnostic signal is suppressed before an error message is issued.
<b>User entry</b>	0 to 255 s
<b>Factory setting</b>	0 s
<b>Additional information</b>	<i>User role</i> <ul style="list-style-type: none"> <li>■ Operator</li> <li>■ Maintenance</li> <li>■ Specialist</li> </ul>

---

**Restore Factory Settings**



---

<b>Navigation</b>	 Parameter → System → Restore Factory Settings
<b>Description</b>	Use this function to reset the entire device configuration to the factory settings.
<b>Additional information</b>	<i>User role</i> <ul style="list-style-type: none"> <li>■ Operator</li> <li>■ Maintenance</li> <li>■ Specialist</li> </ul>

---

**DeviceAccessLocks.DataStorage**

---

<b>Navigation</b>	 Parameter → System → DeviceAccessLocks.DataStorage
<b>Description</b>	Use this function to lock data storage. Standard function of IO-Link.
<b>Selection</b>	<ul style="list-style-type: none"> <li>■ Unlocked</li> <li>■ Locked</li> </ul>
<b>Factory setting</b>	Unlocked
<b>Additional information</b>	<i>User role</i> <ul style="list-style-type: none"> <li>■ Operator</li> <li>■ Maintenance</li> <li>■ Specialist</li> </ul>

**Activate parametrization lock**

**Navigation**  Parameter → System → Activate parametrization lock

**Description** Use this function to lock the parameterization of the device.

**Additional information** *User role*

- Maintenance
- Specialist

**Deactivate parametrization lock**

**Navigation**  Parameter → System → Deactivate parametrization lock

**Description** Use this function to unlock the parameterization of the device.

**Additional information** *User role*

- Maintenance
- Specialist



**15.1.4 Observation**

*Navigation*  Observation

▶ Observation		
	▶ Process Data Input	→  87

**Process Data Input**

*Navigation*  Observation → Process Data Input

▶ Process Data Input		
	Process Data Input. Temperature value	→  88
	Process Data Input. Sensor status	→  88
	Process Data Input. Switch output	→  88

---

**Process Data Input. Temperature value**

---

<b>Navigation</b>	 Observation → Process Data Input → Process Data Input. Temperature value
<b>Description</b>	Displays the temperature value that is currently measured.
<b>Additional information</b>	<i>User role</i> <ul style="list-style-type: none"><li>▪ Operator</li><li>▪ Maintenance</li><li>▪ Specialist</li></ul>

---

**Process Data Input. Sensor status**

---

<b>Navigation</b>	 Observation → Process Data Input → Process Data Input. Sensor status
<b>Description</b>	Displays the current sensor status.
<b>Additional information</b>	<i>User role</i> <ul style="list-style-type: none"><li>▪ Operator</li><li>▪ Maintenance</li><li>▪ Specialist</li></ul>

---

**Process Data Input. Switch output**

---

<b>Navigation</b>	 Observation → Process Data Input → Process Data Input. Switch output
<b>Description</b>	Displays the current switch status.
<b>User interface</b>	<ul style="list-style-type: none"><li>▪ 0 (Off)</li><li>▪ 1 (On)</li></ul>
<b>Additional information</b>	<i>User role</i> <ul style="list-style-type: none"><li>▪ Operator</li><li>▪ Maintenance</li><li>▪ Specialist</li></ul>











[www.addresses.endress.com](http://www.addresses.endress.com)

---