



72 x 72 mm

### Features :

- ▶ 6 digits dual display for Timer / Counter / Rate / Batch
- ▶ Dual set point
- ▶ Programmable input scaling
- ▶ User Configurable relay 2 operation mode
- ▶ Unidirectional, Bi - directional, Quadrature counting modes
- ▶ User configurable Time / Count / Rate / Batch
- ▶ Compact size

Certifications :  

## Technical specifications

Display specifications	
Display	6 digits dual display for Timer / Counter / Rate / Batch
LED indication	Out1, Out2 CNTR: counter, R: Rate , B: Batch TMR: Timer, S: sec, M:minutes , H: hours
Input specifications	
Sensor type	NPN / PNP
Count inputs	5 to 30VDC from proximity switches, encoders, solid state devices, potential free contacts like limit switches, relays
Input frequency	a) 10Hz b) 15KHz
Start input	Pulse, Gate, Level
Accuracy	Rate : 0.05% Timer : $\pm 0.05\%$ of setting or 50 ms whichever is greater
Output specifications	
Sensor supply	Inbuilt, 12V DC, 30mA
Relay outputs	2
Contact rating	1SPDT :5A@230VAC/12VDC 1SPST :5A@230VAC/12VDC
Functional specifications	
Modes	<b>Timer</b> : On delay, Interval, Cyclic On first, Cyclic Off first, Instantaneous + Delayed at start pulse, Instantaneous + Delayed at power on, Motor reverse, Batch. <b>Counter</b> : ON delay, Interval, Time pulse repeat, Auto reset <b>Rate</b> : HA / LA / BAND
Time ranges	<b>Timer</b> : 9999.99/99999.9/999999 sec, 9999.59 min : sec / 99999.9 min, 999999 min 9999.59 hr: min / 99999.9/999999 hr <b>Counter</b> : Selectable least count 0.0001, 0.001, 0.01, 0.1 & 1
Counting direction	Unidirectional, Bi-directional & Quadrature
Set point	2
Scale factor	Programmable from 0.00001 to $9.99999 \times 10^n$ Where n = -5, -4, -3, -2, -1, 0, 1, 2
Reset	Front, Remote, Power interruption (Minimum reset time for remote reset is 10ms)
Memory retention	Yes
Auxiliary supply specifications	
Supply voltage	90 to 270V AC / DC (50 / 60Hz)
Environmental specifications	
Temperature	Operating : 0 to 50°C (32 to 122°F) Storage : -20 to 75°C (-4 to 167°F)
Humidity (non - condensing)	95% RH

Mechanical specifications	
Mounting	Panel mount
Weight	200gms

## Terminal connections

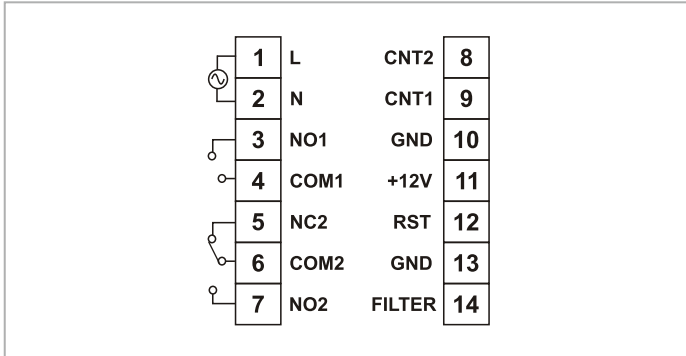

## Dimensions

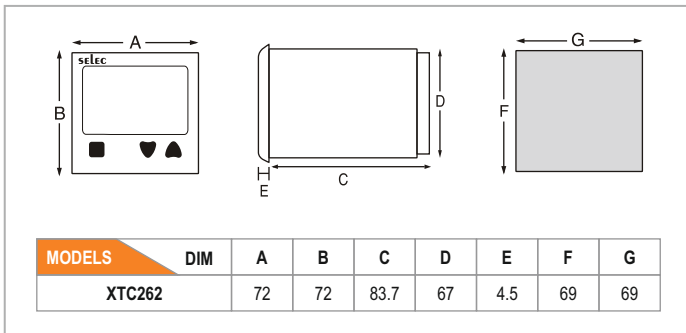

## Compliance

Applicable EMI / EMC Standards		
Product Standard		
Category	Reference Standards	Testing Level
Electrostatic Discharge	IEC 61000-4-2	Level-3
Electrical Fast Transient / Brust	IEC 61000-4-4	Level-3
Electromagnetic Field	IEC 61000-4-3	Level-3
Surge	IEC 61000-4-5	Level-3
Conducted RF	IEC 61000-4-6	Level-2
Rated Power Frequency	IEC 61000-4-8	Level-4
Voltage Dip / Short Interruptions	IEC 61000-4-11	Level-3
Conducted Emissions	CISPR-11	Class-B
Rated Emissions	CISPR-22	Class-A
Emission & Immunity	IEC 61326-1	
Safety	IEC 61010-1	
PFMF (Passing criteria)	IEC 61000-4-8	Class A

## Timing diagrams

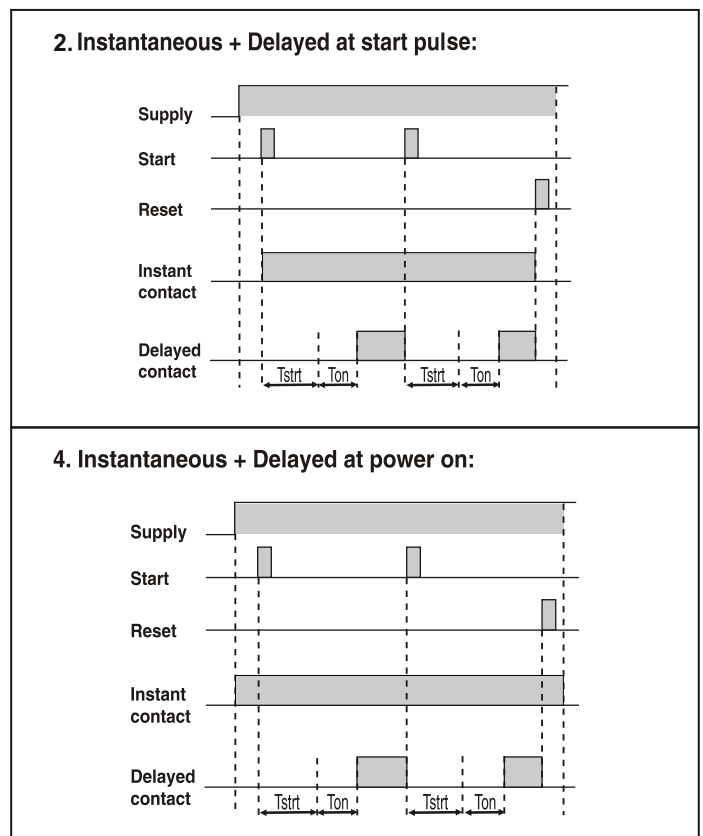
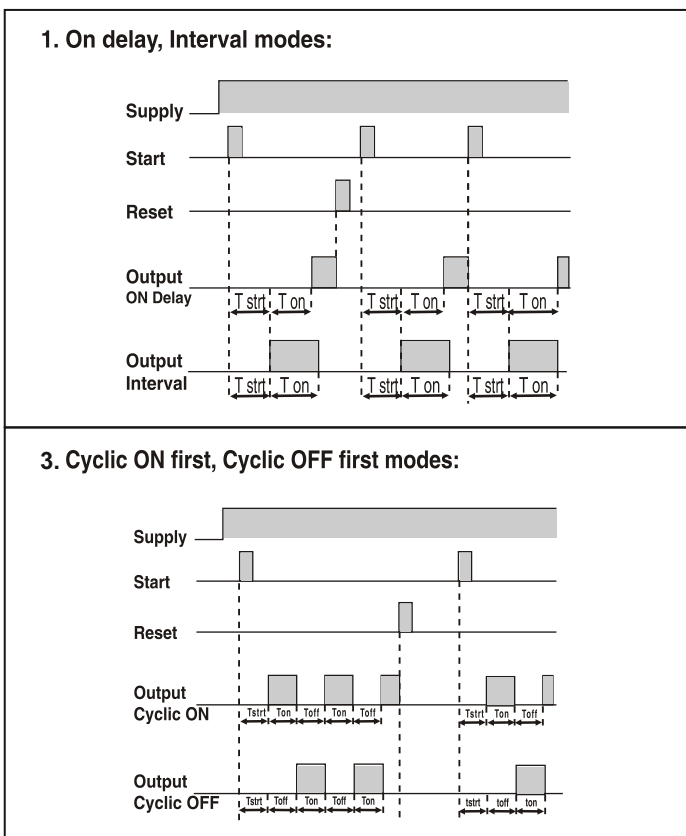

## 5. Motor reverse mode:

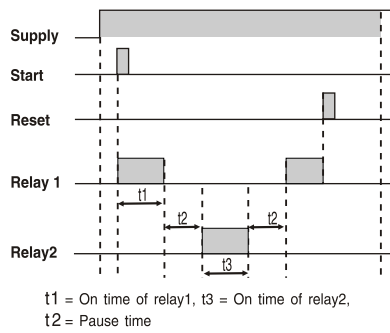

## 6. Motor reverse manual mode:

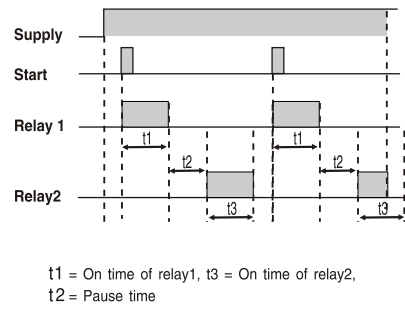

## 7. Batch mode

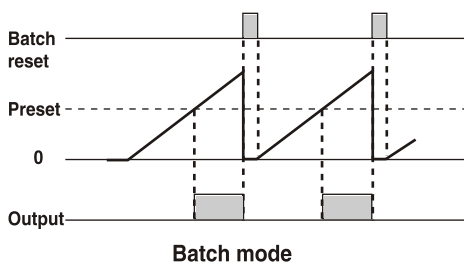

## Typical application of Continuous start and reset in On delay mode:

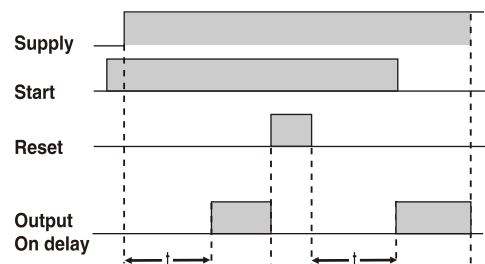

## Typical application of Gate start in On delay mode:

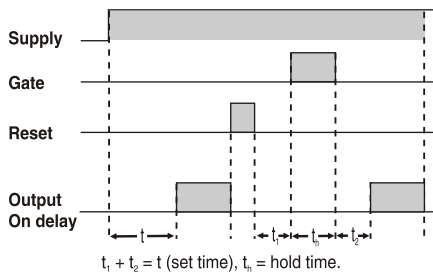

## Typical application of Level start in On delay mode:

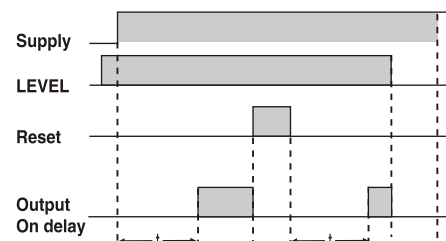

## Ordering information

Product Code	Output1	Output2	Supply voltage	Certification
XTC262	RELAY (5A)	RELAY (5A)	90 to 270V AC / DC	CE