









Ficha técnica

Rueda BH-PGI 1-0170

Codigo				Tipo cojinete Eje					
1-0170	60	40	21	—	-	-	10	85	62



Características

Fabricada con chapa de acero hasta 2 m/m de espesor.
Soporte con doble rodamiento a bolas.
Acabado cincado brillante.
Fabricadas según normas europeas EN 12528/12530.

Datos técnicos

Diámetro: 60 mm
Carga: 40 kg
Tipo de cojinete: Cojinete Liso
Ancho de Banda de rodadura: 21 mm
Diámetro agujero pasante: 10 mm
Altura total: 85 mm
Radio de giro: 62 mm

Archivos CAD

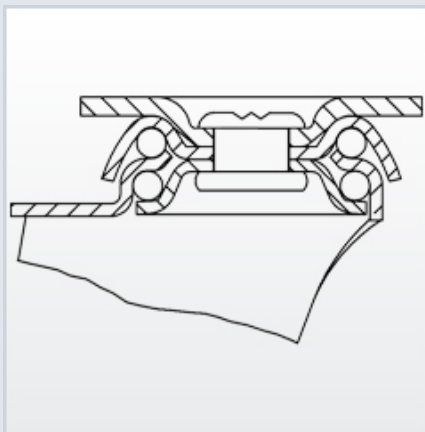

Rueda

PGI (Goma)
Núcleo de poliamix y banda de goma gris
Rango de temperatura: -20° ÷ +60°

