

# E11032

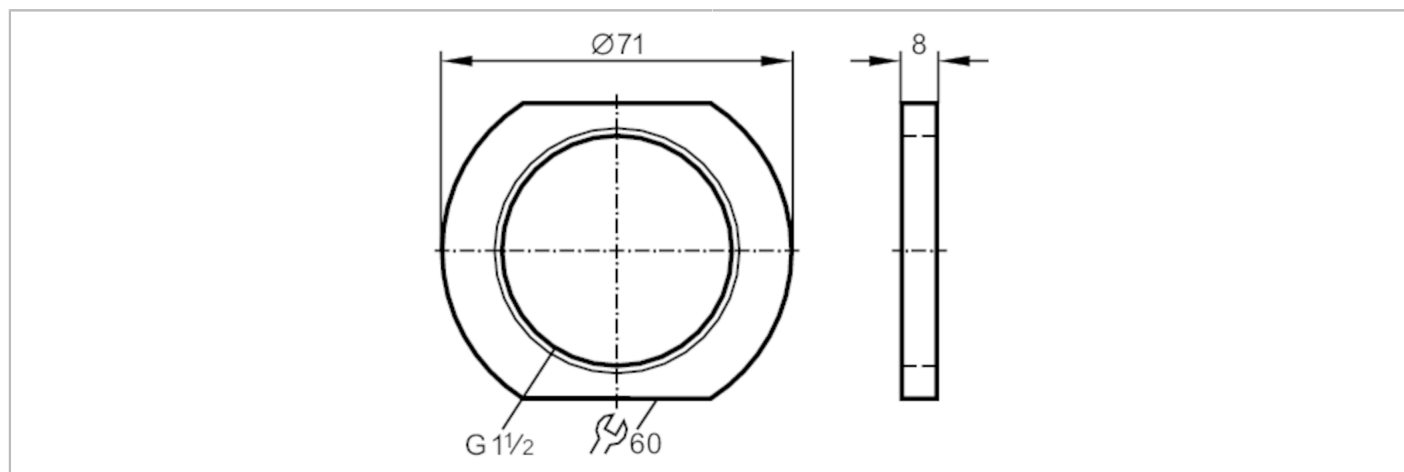

## Lock nut for mounting adapter

NUT MOUNTING ADAPTER PVDF



Application	
Design	for mounting adapters
Operating conditions	
Ambient temperature [°C]	-25...110
Mechanical data	
Weight [g]	29.3
External diameter [mm]	71
Materials	PVDF
Remarks	
Pack quantity	1 pcs.